

VERLIS[®]

User Manual



EAZ0061B46F Rev. F

Legal Information

Trademarks

Snap-on, ShopStream Connect, SureTrack, Fast-Track Troubleshooter, ProDemand, ShopKey Pro and VERUS are trademarks registered in the United States and other countries of Snap-on Incorporated. All other marks are trademarks or registered trademarks of their respective holders.

The *Bluetooth* word mark and logos are registered trademarks owned by Bluetooth SIG, Inc. and any use of such marks by Snap-on Incorporated is under license.

Copyright Information

© 2018 Snap-on Incorporated. All rights reserved.

Disclaimer of Warranties and Limitation of Liabilities

All pictures and illustrations shown are for reference purposes only. All information, specifications and illustrations in this manual are based on the latest information available at the time of printing and are subject to change without notice. While the authors have taken due care in the preparation of this manual, nothing contained herein:

- Modifies or alters in any way the standard terms and conditions of the purchase, lease, or rental agreement under the terms of which the equipment to which this manual relates was acquired.
- Increases in any way the liability to the customer or to third parties.

Snap-on[®] reserves the right to make changes at any time without notice.

IMPORTANT:

Before operating or maintaining this unit, please read this manual carefully paying extra attention to the safety warnings and precautions.

Manuals / Technical Documentation - The information in this manual is periodically revised to ensure the latest information is included. Download the latest version of this manual and other related technical documentation from the Snap-on Diagnostics website.

Software License Information

Use of Software is governed by the terms and conditions of the End User License Agreement. The End User License Agreement is provided with the diagnostic tool and the device should not be initially operated until the End User License Agreement is read. Use of the device acknowledges your acceptance of the End User License Agreement.

Patent Information

For a listing of Snap-on products that are protected by patents in the United States and elsewhere, visit: <https://patents.snapon.com>

Contact Information (North America)

Websites:

Snap-on Diagnostics and Information

- <http://diagnostics.snapon.com>

Software Subscription - Learn how to always have the latest diagnostic software on your Diagnostic Tool.

- <http://diagnostics.snapon.com/theprogram>

Training and Support (by platform) - Find specific support and training information for your Diagnostic Tool.

- <http://diagnostics.snapon.com/cc.htm>

Forums and Training (all platforms) - Watch free instructional product videos. Connect with and share your Diagnostic Tool questions, ideas and success stories.

- <http://diagnostics.snapon.com/ForumsandTraining.htm>

Manuals / Technical Documentation (all platforms) - The information in this manual is periodically revised to ensure the latest information is included. Download the latest version of this manual and other related documentation at:

- <http://diagnostics.snapon.com/usermanuals>

Phone / E-mail - Technical Assistance

1-800-424-7226 / diagnostics_support@snapon.com

For technical assistance in all other markets, contact your selling agent.

Regulatory Information



This product has been tested to the requirements of CAN/CSA-C22-2 No. 61010-1, second edition, including Amendment 1, or a later version of the same standard incorporating the same level of testing requirements.

Safety Information

READ ALL INSTRUCTIONS

For your own safety, the safety of others, and to prevent damage to the product and vehicles upon which it is used, it is important that all instructions and safety messages in this manual and the accompanying *Important Safety Instructions* manual be read and understood by all persons operating, or coming into contact with the product, before operating. We suggest you store a copy of each manual near the product in sight of the operator.

For your safety, read all instructions. Use your diagnostic tools only as described in the tool user's manual. Use only manufacturer recommended parts and accessories with your diagnostic tools.

This product is intended for use by properly trained and skilled professional automotive technicians. The safety messages presented throughout this manual and the accompanying *Important Safety Instructions* manual are reminders to the operator to exercise extreme care when using this product.

There are many variations in procedures, techniques, tools, and parts for servicing vehicles, as well as in the skill of the individual doing the work. Because of the vast number of test applications and variations in the products that can be tested with this instrument, we cannot possibly anticipate or provide advice or safety messages to cover every situation. It is the responsibility of the automotive technician to be knowledgeable of the system being tested. It is essential to use proper service methods and test procedures. It is important to perform tests in an appropriate and acceptable manner that does not endanger your safety, the safety of others in the work area, the equipment being used, or the vehicle being tested.

It is assumed that the operator has a thorough understanding of vehicle systems before using this product. Understanding of these system principles and operating theories is necessary for competent, safe and accurate use of this instrument.

Before using the equipment, always refer to and follow the safety messages and applicable test procedures provided by the manufacturer of the vehicle or equipment being tested. Use the product only as described in its user manual. Use only manufacturer recommended parts and accessories with your product.

Read, understand and follow all safety messages and instructions in this manual, the accompanying *Important Safety Instructions* manual, and on the test equipment.

Environmental Conditions:

- This product is intended for indoor use only
- This product is rated for Pollution Degree 2 (normal conditions)

Safety Signal Words

All safety messages contain a safety signal word that indicates the level of the hazard. An icon, when present, gives a graphical description of the hazard. Safety Signal words are:

DANGER

Indicates an imminently hazardous situation which, if not avoided, will result in death or serious injury to the operator or to bystanders.

WARNING

Indicates a potentially hazardous situation which, if not avoided, could result in death or serious injury to the operator or to bystanders.

CAUTION

Indicates a potentially hazardous situation which, if not avoided, may result in moderate or minor injury to the operator or to bystanders.

Safety Message Conventions

Safety messages are provided to help prevent personal injury and equipment damage. Safety messages communicate the hazard, hazard avoidance and possible consequences using three different type styles:

- Normal type states the hazard.
- **Bold type states how to avoid the hazard.**
- *Italic type states the possible consequences of not avoiding the hazard.*

An icon, when present, gives a graphical description of the potential hazard.

Safety Message Example

WARNING



Risk of unexpected vehicle movement.

- **Block drive wheels before performing a test with engine running.**

A moving vehicle can cause injury.

Important Safety Instructions

For a complete list of safety messages, refer to the accompanying *Important Safety Instructions manual*.

SAVE THESE INSTRUCTIONS

Contents

Safety Information	iv
Contents	vi
Chapter 1: Using This Manual	1
Conventions	1
Bold Text	1
Symbols	1
Terminology	1
Notes and Important Messages	2
Procedures	2
Hyperlinks	2
Tool Help	2
Chapter 2: Introduction	3
Features and Specifications	4
Diagnostic Tool	4
Technical Specifications	7
Built-in Stand	7
Wrist Strap (Optional)	7
Power Conservation	8
Power Sources	8
Scan Module (Wireless)	10
Functional Description	10
Technical Specifications	11
Power Sources	11
Chapter 3: Basic Operation and Navigation	12
Turning On/Off and Emergency Shutdown	12
Turning On	12
Turning Off	12
Emergency Shutdown	12
Controls and Indicators	13
Control Buttons	13
LEDs	13
Basic Navigation	14
Starting the ShopStream Diagnostic Suite Program	14
Home Screen Layout	14
Function Icons	15
Toolbar	16
Windows Toolbar	17
Virtual Keyboard	17
Wi-Fi Setup	19
Chapter 4: Scanner Function	20
Demonstration Program	20
Basic Operation and Navigation	21
Screen Messages	21
Making Selections	22

Scanner Screen Layout	22
Menu Options.....	32
Scanner Operation	35
Connecting the Scan Module.....	35
Vehicle Identification	35
Vehicle System Selection	37
Vehicle Test Selection	41
Stopping Communication and Exiting the Scanner	52
Chapter 5: Scan Module Operation	54
Overview.....	54
Pairing The Scan Module	55
Checking Scan Module Paired Status	56
Data Cable Connection	57
Troubleshooting.....	58
No Communication Message.....	58
Signal Loss / Out of Range Alarm.....	58
Checking Hardware Status	59
Recovery Procedure	61
Updating Scan Module Firmware	63
Chapter 6: OBD Direct Operations.....	67
OBD Health Check	68
Global OBD II Code Check	68
Global OBD II Clear Codes.....	69
Readiness Monitors	69
MIL Status.....	70
OBD Diagnose.....	70
Start Communication	70
Connector Information	74
Manual Protocol Selection	74
Chapter 7: Guided Component Test Operations	75
Vehicle Identification.....	75
Menu Options, Guided Component Test.....	76
Creating a Favorites List	78
Identifying a Test Vehicle	79
Operations	81
Component Information	81
Tests	82
Chapter 8: Scope Multimeter.....	86
Getting Started	86
Capabilities	86
Leads, Probes and Adapters	88
Menu Icon Options, Scope Multimeter.....	91
Navigation.....	92
Screen Layout.....	92
Making Selections.....	97
Operations	97
Starting the Scope and Multimeter.....	97
Measurement Out of Range.....	99
Scope and Multimeter Setup.....	99

Chapter 9: Repair Information	111
About ShopKey Pro	111
Chapter 10: Vehicle History Operations	113
Screen Layout	113
Vehicle History Main Body (Records List).....	113
Vehicle History Toolbar	114
Chapter 11: Data Manager Operations	119
Screen Layout	119
Navigation	120
Operations	121
My Data.....	121
Up	121
Open	121
New.....	122
Delete.....	123
Rename	124
Properties.....	125
Shortcut.....	125
Email	126
Viewing Saved Files	131
ShopStream Connect™	131
Saved File Structure	131
Scanner DataViewer Operation.....	132
Menu Bar	133
Display Toolbar	136
Navigation Tools	137
Customizing the Display.....	139
Customizing the Parameter List.....	140
Scope Viewer	142
Image Viewer	143
Chapter 12: Help Operations	144
Using the Help Toolbar.....	144
Chapter 13: System Settings Operations	145
Paired Devices	145
Pairing the Wireless Scan Module	146
Shop Information	147
Data Backup	148
Backup	148
Restore	149
Chapter 14: SureTrack	150
Getting Started Using SureTrack.....	150
Using SureTrack in the Scanner Function.....	151
Common Replaced Parts Graph.....	151
Dashboard Feature Information	152
SureTrack Status Messages.....	153
Using the SureTrack Community	
(within ShopKey Pro).....	154
Getting Started.....	154

Logging In (existing active account).....	157
Logging In (existing expired account)	158
About Upgrade Reminder Messages	158
Chapter 15: ShopStream Update Tool (SST)	159
Basic Operation	159
Manual Software Download.....	161
Installing Software Updates.....	163
Installing Software Upgrades.....	165
Chapter 16: Maintenance	167
Cleaning the Touch Screen	167
Calibrating the Touch Screen	167
Cleaning and Inspecting the Diagnostic Tool	168
Fan Filter Service	168
Battery Pack Service	169
Battery Pack Safety Guidelines	169
Replacing the Battery Pack.....	170
Disposing of the Battery Pack.....	170
Battery Pack Calibration	171
System Restore	171
Scan Module.....	172
Replacing the Protective Handgrip.....	172

This manual contains basic operating instructions and is structured in a manner to help you become familiar with your diagnostic tool features and perform basic operations.

The illustrations in this manual are intended as reference only and may not depict actual screen results, information, functions or standard equipment. Contact your sales representative for availability of other functions and optional equipment.

1.1 Conventions

1.1.1 Bold Text

Bold emphasis is used in procedures to highlight selectable items such as buttons and menu options.

Example:

- Select **Functions**.

1.1.2 Symbols

The “greater than” arrow (>) indicates an abbreviated set of selection instructions.

Example:

- Select **Utilities > Tool Setup > Date**.

The above statement abbreviates the following procedure:

1. Select the **Utilities** icon.
2. Select the **Tool Setup** submenu.
3. Highlight the **Date** option from the submenu.

1.1.3 Terminology

The term “select” describes tapping/touching an icon on the touch screen, or highlighting an icon or menu choice and then selecting the confirmation menu choice such as **Continue, Accept, OK, Yes**, or other similar choice.

Example:

- Select **Reset**.

The above statement abbreviates the following procedure:

1. Navigate to the **Reset** icon.
2. Select the **Reset** icon with your stylus.

1.1.4 Notes and Important Messages

The following messages are used.

Note

A note provides helpful information such as additional explanations, tips, and comments.

Example:

**NOTE:**

For additional information refer to...

Important

Important indicates a situation which, if not avoided, may result in damage to the test equipment or vehicle.

Example:

IMPORTANT:

Disconnecting the USB cable during vehicle communication can cause damage to the ECM.

1.1.5 Procedures

An arrow icon indicates a procedure.

Example:

**To change screen views:**

1. Select **View**.
The dropdown menu displays.
2. Select an option from the menu.
The screen layout changes to the format you selected.

1.1.6 Hyperlinks

Hyperlinks, or links, that take you to other related articles, procedures, and illustrations are available in electronic documents. Blue colored text indicates a selectable hyperlink.

Example:

IMPORTANT:

Read all applicable [Safety Information](#) before using this tool!

1.1.7 Tool Help

To display help topics for this tool, select a help option from the Help menu.

This chapter introduces the basic features of the Diagnostic Tool, including the control buttons, data ports, battery pack, and power sources. Your Diagnostic Tool is a specialized personal automotive diagnostic solution that combines information with test instrumentation to help you diagnose symptoms, codes, and complaints quickly and efficiently. There are basically two main components to the VERUS[®] Diagnostic Tool:

- **Diagnostic Tool**—the central processor and system monitor with integral scope.
- **Scan Module (Wireless)** (wireless models) — wireless device for accessing vehicle data.

This manual describes the operation of these devices and how they work together to deliver diagnostic solutions.

There are two versions of the VERUS Diagnostic Tool: (operation and function are similar for both)

Standard Version

On early-model VERUS Diagnostic Tools the Scanner is built (integrated) into the Diagnostic Tool. During scanner testing, the data cable is connected directly from the Diagnostic Tool to the data link connector on the vehicle.

Wireless Version

On later-model VERUS Diagnostic Tools the Scanner (referred to as a Scan Module) is a separate unit that communicates wirelessly with the Diagnostic Tool. During scanner testing, the data cable is connected directly from the Scan Module to the data link connector on the vehicle.

IMPORTANT:

Earlier standard Diagnostic Tools can be converted to operate with the wireless Scan Module, contact your sales representative for details.

2.1 Features and Specifications

2.1.1 Diagnostic Tool

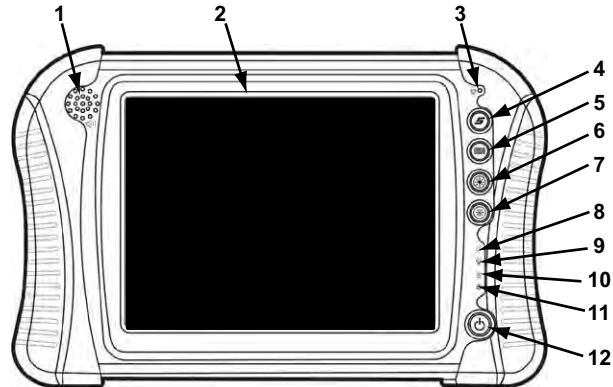

- 1— Audio Speaker
- 2— Touch Screen Display
- 3— Microphone
- 4— S (Shortcut) Button
- 5— Virtual Keyboard Button
- 6— Brightness Up Button
- 7— Brightness Down Button
- 8— Hard Drive Activity LED
- 9— Wireless LAN Activity LED
- 10— Battery Charging LED
- 11— Main Power LED
- 12— Power Button

Figure 2-1 Front view

Standard Version (Early-Models)

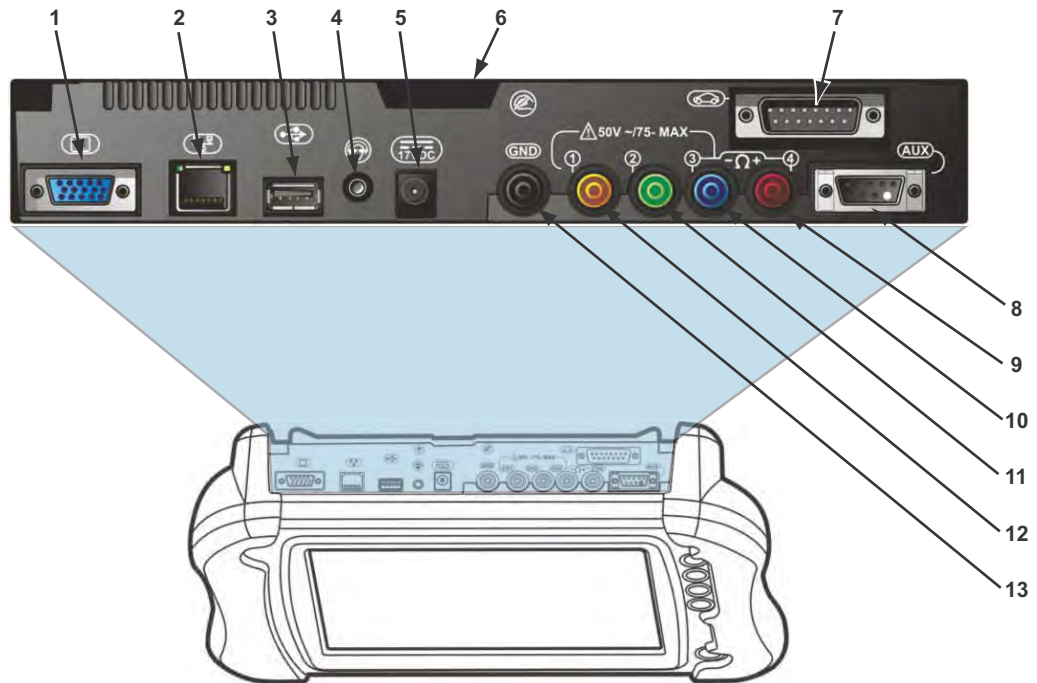

- 1— VGA (video graphics array) Connector
- 2— LAN (local area network) Jack
- 3— USB (universal serial bus) Jack
- 4— Audio (head phone) Jack
- 5— DC Power Supply Input Jack
- 6— Fan Filter
- 7— Data Cable Connector
- 8— Scope Auxiliary Connector
- 9— Channel 4 Jack
- 10—Channel 3 Jack
- 11—Channel 2 Jack
- 12—Channel 1 Jack
- 13—Common Ground Jack

Figure 2-2 Top view, standard model

Wireless Version (Later-Models)

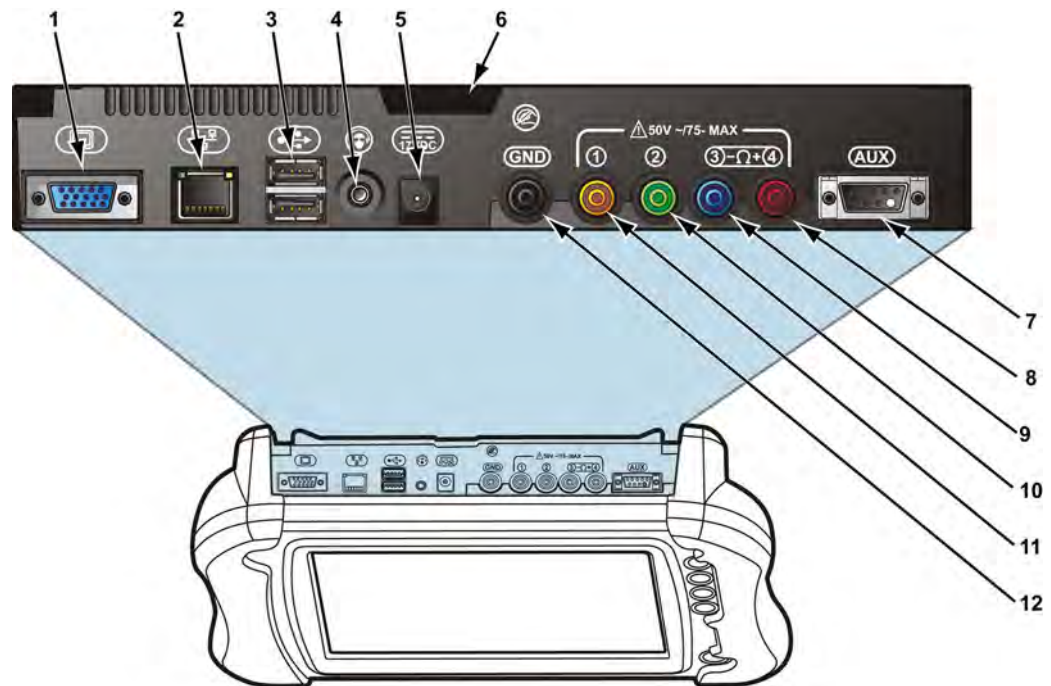

- 1— VGA (video graphics array) Connector
- 2— LAN (local area network) Jack
- 3— USB (universal serial bus) Jacks (2)
- 4— Audio (head phone) Jack
- 5— DC Power Supply Input Jack
- 6— Fan Filter
- 7— Scope Auxiliary Connector
- 8— Channel 4 Jack
- 9— Channel 3 Jack
- 10—Channel 2 Jack
- 11—Channel 1 Jack
- 12—Common Ground Jack

Figure 2-3 Top view, wireless model

2.1.2 Technical Specifications

Item	Description / Specification
Touch Screen	5-Wire Resistive Touch Panel
Display	10.4 inch, outdoor enhanced, TFT LCD
	1024 x 768 resolution, 262,144 Colors
Processor	Standard: 600MHz Intel Celeron M Wireless: Intel Atom 1.6GHz
Operating System	Microsoft Windows Embedded Standard XPe SP3
Communications	802.11 b/g/n Wireless
	Wireless <i>Bluetooth</i> [®] 2.0 Technology
	10/100 Ethernet Jack
Memory	Standard: 500MB RAM
	Wireless: 1GB RAM
Battery	Lithium Ion Smart Battery Pack
	Approximate 4 hour run time
	Approximate 4 hour charge time (unit operating)
	Approximately 8 hour charge time, (unit not operating)
Power Supply	Supply Rating; 12–17 VDC. 3.53A
DC Operating Voltage	17VDC 60W, LPS (limited power source)
Width	14.9 in. (358 mm)
Height	9.17 in. (233 mm)
Depth	3.07 inches (78 mm)
Weight (including battery)	7.5 lb (3402 g)
Operating Temperature Range (ambient)	At 0 to 90% relative humidity (non-condensing) 32 to 113°F (0 to 45°C)
Storage Temperature (ambient)	At 0 to 70% relative humidity (non-condensing) –4 to 131°F (–20 to 55°C)
Operating Altitude	Maximum 2000 m
Environmental Conditions	This product is intended for indoor use only
	This product is rated for Pollution Degree 2 (normal conditions)

2.1.3 Built-in Stand

The Diagnostic Tool has a built-in, metal stand attached to the back. When the stand is not in use, it is secured to the back of the Diagnostic Tool by an integrated casing hook. When extended, the stand allows the Diagnostic Tool to rest at a 45° angle for hands-free viewing.

2.1.4 Wrist Strap (Optional)

An adjustable wrist strap that attaches to the back of the Diagnostic Tool to secure and stabilize the Diagnostic Tool while you work is available as an option. Using the wrist strap allows the Diagnostic Tool to comfortably rest on your forearm and leaves a hand free for connecting test leads and operating the touch screen. The strap also eliminates the possibility of the Diagnostic

Tool falling off a vehicle due to vibrations or other movement, and also prevents you from accidentally dropping the Diagnostic Tool.

2.1.5 Power Conservation

To conserve power, the Diagnostic Tool uses a power saving strategy when left idle. Standby mode engages following a period of inactivity. During standby, the random access memory (RAM) remains powered, but all other functions are turned off. The screen shuts off and the Main Power LED remains illuminated when in standby mode.



NOTE:

The Standby mode characteristics can be configured by selecting **Power Options** from the Windows Control Panel menu.

2.1.6 Power Sources

Your Diagnostic Tool can receive power from any of the following sources:

- [Internal Battery Pack](#)
- [Docking Station \(Optional\)](#)
- [AC/DC Power Supply](#)
- [Vehicle Power](#)

Internal Battery Pack

The Diagnostic Tool can be powered from a rechargeable lithium ion battery located on the bottom of the Diagnostic Tool under the right handgrip ([Figure 2-5](#)). A fully charged battery provides sufficient power for about four hours of constant operation.

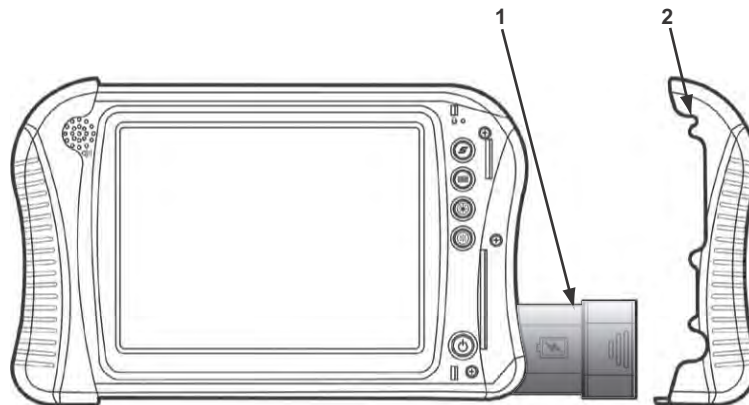

1— Internal Battery Pack

2— Right Handgrip

Figure 2-4 Battery pack location

The battery is recharged on demand whenever the Diagnostic Tool is placed in the optional docking station, or the AC/DC power supply is connected to a voltage source.

Docking Station (Optional)

The Diagnostic Tool can be powered and operated when installed on the optional docking station. The docking station also powers the internal battery pack charging process and allows USB connectivity for attaching peripherals. Contact your sales representative for additional details.

AC/DC Power Supply

The Diagnostic Tool can be powered from a wall socket using the AC/DC power supply and power cord. The AC/DC power supply also powers the internal battery pack charging process.

Vehicle Power

The standard Diagnostic Tool can be powered through the DLC when connected to an OBD-II vehicle with the data cable. However, battery pack charging is not available when the Diagnostic Tool is being powered by the DLC.

2.2 Scan Module (Wireless)

The wireless Scan Module is provided as standard equipment on all late-model VERUS Diagnostic Tools. Early VERUS Diagnostic Tools, which are designed to operate with a cable connection to the test vehicle, can also be converted to operate with the wireless Scan Module.

2.2.1 Functional Description

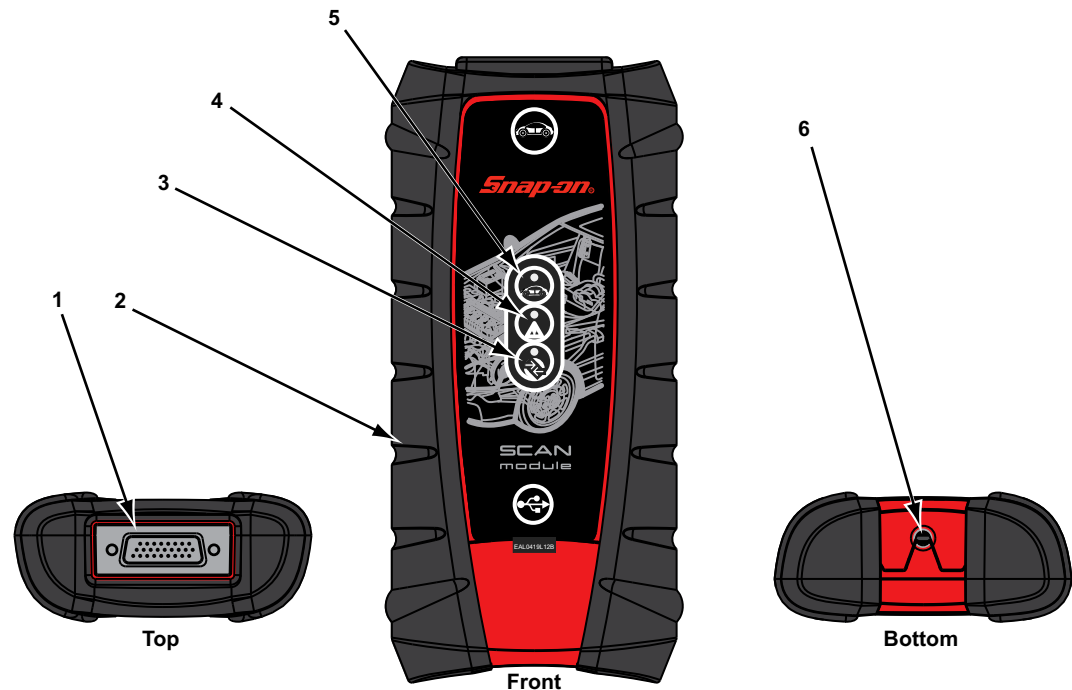

- 1— Data cable connector
- 2— Memory card port (remove protective hand grip for access)
- 3— Bluetooth LED (green)
- 4— Communication issue LED (red)
- 5— Vehicle power LED (green)
- 6— Universal serial bus (USB) jack (remove protective hand grip for access)

Figure 2-5 Scan Module

Wireless Communication

The wireless Scan Module is a communication device that transmits vehicle data to the Diagnostic Tool without a physical connection. The working range of the transmitter is about 30 feet (9.14 m). A signal lost due to moving out of range automatically restores itself when the Diagnostic Tool is brought closer to the Scan Module. The Scan Module sounds a tone and the Diagnostic Tool shows a warning message when the signal is lost.

2.2.2 Technical Specifications

Item	Description / Specification
Communications	Wireless <i>Bluetooth</i> [®] 2.0 Technology
USB Power	5V @ 500mA
Data Cable Connector Power	8V to 32V, Maximum 12 Watts
Width	8.04 in. (204.3 mm)
Height	3.82 in. (97 mm)
Depth	1.66 in. (42.1 mm)
Weight	0.9 lb (0.408 kg)
Operating Temperature Range (ambient)	At 0 to 90% relative humidity (non-condensing) 32 to 113°F (0 to 45°C)
Storage Temperature (ambient)	At 0 to 70% relative humidity (non-condensing) -4 to 140°F (-20 to 60°C)
Operating Altitude	Maximum 2000 m
Environmental Conditions	This product is intended for indoor use only
	This product is rated for Pollution Degree 2 (normal conditions)

2.2.3 Power Sources

The Scan Module operates on 12V or 24V vehicle power, which it receives through the data cable connector. The Scan Module powers on whenever it is connected to an OBD-II/EODB compliant data link connector (DLC). For non OBD-II/EODB compliant vehicles, the Scan Module can be powered from a suitable power port on the test vehicle using the auxiliary power cable supplied with your kit.

Basic Operation and Navigation

This chapter describes the basic operation, controls and navigation of the Diagnostic Tool.

3.1 Turning On/Off and Emergency Shutdown

The following sections describe how to turn the Diagnostic Tool on and off and how to perform an emergency shutdown.

Before using the Diagnostic Tool, make sure the battery is fully charged or is connected to an AC/DC power supply. see [Power Sources](#) on page 8.

3.1.1 Turning On

Press the Diagnostic Tool **Power** button to switch the Diagnostic Tool on. The system boots up, then opens the Home screen ([Figure 3-2](#)).

3.1.2 Turning Off

All vehicle communication must be terminated before shutting down the Diagnostic Tool. A warning message displays if you attempt to shut down while the Scan Module is communicating with a vehicle. Forcing a shut down while communicating may lead to ECM problems on some vehicles. Exit the Scan Module before turning off.

Before turning the Diagnostic Tool off, it is highly recommended to back up personal and saved data to a USB mass storage device on a regular basis to prevent loss in the event of system corruption or hard disk drive failure



To turn off the Diagnostic Tool:

1. Navigate to the Home screen.
2. Select the **Exit** icon.
3. From the Windows desktop, open the Windows **Start** menu.
4. Select **Turn Off Computer**.
5. Select **Turn Off** in the dialog box.

The open programs close and the power turns off.

3.1.3 Emergency Shutdown

In case of emergency, press and hold the **Power** button for 5 seconds to force a shutdown.





3.2 Controls and Indicators

The external controls on the Diagnostic Tool are simple because most operations are controlled through the touch screen. Touch screen navigation is menu driven, which allows you to quickly locate the test, procedure, or data that you need through a series of choices and questions. Detailed descriptions of the menu structures are found in the chapters for the various modules.

The following sections describe the external controls and features of the Diagnostic Tool.

3.2.1 Control Buttons

There are five control buttons located on the right side of the Diagnostic Tool near the handgrip:

Name	Button	Description
S (Shortcut) Button		A function button that provides a shortcut for performing routine tasks.
Keyboard		Opens, and closes, a virtual keyboard on the touch screen.
Brightness Up		Incrementally increases the screen backlighting.
Brightness Down		Incrementally decreases the screen backlighting.
Power		Turns the Diagnostic Tool on and off. Also, press and hold for 5 seconds for emergency shutdown.

All other Diagnostic Tool operations are controlled through the touch screen.

S (Shortcut) Button

Use the S Button to quickly capture an image of the current screen with a single button press. This screen capture function is available at all times, even when operating outside of the Diagnostic Tool software.

3.2.2 LEDs

The four light-emitting diodes indicate certain system conditions:

- Hard Drive Activity LED—illuminates when the central processing unit (CPU) is reading or writing to the hard disk drive (HDD).
- Wireless LAN Activity LED—illuminates when a wireless local area network (LAN) is enabled, flashes when data is being sent or received.
- Battery Charging LED—illuminates when the internal battery pack is charging.
- Main Power LED—illuminates when the Diagnostic Tool is powered on or in Standby mode.

3.3 Basic Navigation

3.3.1 Starting the ShopStream Diagnostic Suite Program

The ShopStream Diagnostic Suite program is automatically started when the Diagnostic Tool is turned on through the Windows “start up” folder function. After the program has started, the ShopStream Diagnostic Suite Home Screen displays, see [Home Screen Layout](#) on page 14. The application runs as a normal Windows program and its window can be minimized, resized and closed like any other Windows program. To access the Windows desktop, minimize the program window.

If the program is exited or closed, select the ShopStream Diagnostic Suite icon from the Windows desktop to start the program.



Figure 3-1 ShopStream Diagnostic Suite desktop icon



NOTE:
The ShopStream Diagnostic Suite can also be started from the Windows Start menu.

3.3.2 Home Screen Layout

The Home screen includes the diagnostic suite toolbar and the Windows toolbar. The Home screen includes function icons, one for each of the primary Diagnostic Tool functions.













- 1— Function Icons
- 2. Toolbar
- 3. Windows Toolbar

Figure 3-2 Sample Home screen

3.3.3 Function Icons

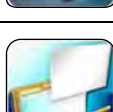
The Function Icons configure the Diagnostic Tool for the type of test to be performed. [Table 3-1](#) gives brief descriptions of the available icons, which operations are available depends upon the individual configuration of your system. Use the stylus or your finger tip to select from the icons.



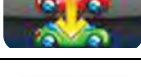



Table 3-1

Name	Icon	Description
Scanner		Configures the Diagnostic Tool to operate as a scan tool. See Scanner Function on page 20.
OBD Direct		Allows you to perform generic OBD-II or EOBD system tests without identifying the specific vehicle. See OBD Direct Operations on page 67.
Guided Component Test		Opens a diagnostic database of specific tests for the identified vehicle. See Guided Component Test Operations on page 75.
Scope Multimeter		Configures the Diagnostic Tool to operate as a lab scope, graphing multimeter, or digital multimeter. See Scope Multimeter on page 86.
Repair Information		Provides the information needed to make repairs once you have made your diagnosis. The linked program varies by region. See Repair Information on page 111.
Vehicle History		Identifies the test vehicle and organizes and manages work in progress and service records. See Vehicle History Operations on page 113.
Data Manager		Opens the organization system for saved data files. See Data Manager Operations on page 119.
Help		Opens the on-line help for the system. See Help Operations on page 144.
System Settings		Establishes and manages connections to peripheral devices, such as the Scan Module. See System Settings Operations on page 145.
Exit		Closes the Diagnostic Tool software and returns the display to the Windows desktop. See Turning Off on page 12.

3.3.4 Toolbar

Operation of the icons located on the toolbar are described in the table below:

Table 3-2

Name	Icon	Description
Home		Selecting this icon returns you to the Home screen from any test.
Desktop		Selecting this icon opens and closes the standard Windows toolbars at the top and bottom of the screen, which allow you access to the Windows desktop.
Menu		Selecting this icon opens a menu that provides information and basic operations and features for the current screen.
Change Vehicle		The currently identified vehicle is shown to the right of the icons, selecting allows you to change the identified test vehicle.
View Record		Selecting the icon opens an editable worksheet of vehicle records.
Hardware Status		Indicates the connectivity status of the Scan Module.
		Indicates the connectivity status of the Scope Multimeter.

Menu Options

The Menu icon on the Toolbar at the base of the display screen opens a list of basic operations and features. The list of options varies depending upon which module, or tool function, is active. Selecting a menu item opens a submenu of choices, and some submenus also open an additional menu. A right arrowhead (▶) indicates additional choices are available. Touch an item to select it. The following Menu options are available from the Home Screen:

- [Safety Information](#)—opens the *Important Safety Instructions* document.
- [Help](#)—allows you to view supporting documentation, selecting opens a submenu.

Safety Information

Selecting **Safety Information** opens a PDF copy of the *Important Safety Instructions* that are included in your Diagnostic Tool kit. The *Important Safety Instructions* document should be read and understood prior to using the Diagnostic Tool.

Help

A variety of utilities and additional resources are available through the Help menu. Basic menu options, which are available for all modules, include:

- [User Manual](#)
- [Version Info](#)
- [Activation Status](#)

User Manual

This option opens this document, which provides overall navigation and operation information for the Diagnostic Tool.

Version Info

This option opens a window showing the version of the software and a copy of the Software License Agreement. Select **OK** to close the window.

Activation Status

This option opens a dialog box with version and licensing details for the system, and activation status for the Diagnostic Tool and all other modules.

3.3.5 Windows Toolbar

This is the standard Windows toolbar. Your Diagnostic Tool is a fully functional personal computer based on the Windows Embedded Standard operating system. Refer to Microsoft documentation for additional information.

Windows System Tray ShopStream Diagnostic Suite Programs

The Windows system tray may contain standard Windows application icons (e.g. Wireless Network Connection Status, Audio volume, etc) and specialized application icons designed for use only on this Diagnostic Tool (e.g. ShopStream Update Tool and Virtual Keyboard). Refer to Microsoft software documentation for additional information on the standard Windows applications. For additional information on the ShopStream Update Tool and Virtual Keyboard, see:

ShopStream Update Tool - [ShopStream Update Tool \(SST\)](#) on page 159

Virtual Keyboard - [Virtual Keyboard](#) on page 17

3.4 Virtual Keyboard

The Virtual Keyboard allows you to type characters and key in information to complete form and data entry fields, similar to a physical keyboard.

The Virtual Keyboard is normally running in the Windows background and can be opened by pressing the Virtual Keyboard button on the Diagnostic Tool. The program can be accessed as follows:

- **Virtual Keyboard button on the Diagnostic Tool control panel** - opens the Virtual Keyboard
- **Virtual Keyboard icon in the Windows system tray** - opens the Virtual Keyboard menu

Menu options include:

- **Hide Virtual Keyboard** - minimizes the keyboard
 - **Close Virtual Keyboard** - closes the Virtual Keyboard program
 - **Show Virtual Keyboard** - displays the keyboard
 - **Settings** - opens the Virtual Keyboard settings window ([Figure 3-5](#))
 - **About** - displays the Virtual Keyboard program software version number
- **Virtual Keyboard program selection from the Windows “All Programs” or “Startup” menus** - starts the Virtual Keyboard program and adds the Virtual Keyboard icon to the Windows system tray



NOTE:

As an alternative, you can connect a USB keyboard to the Diagnostic Tool and use it to key in information.

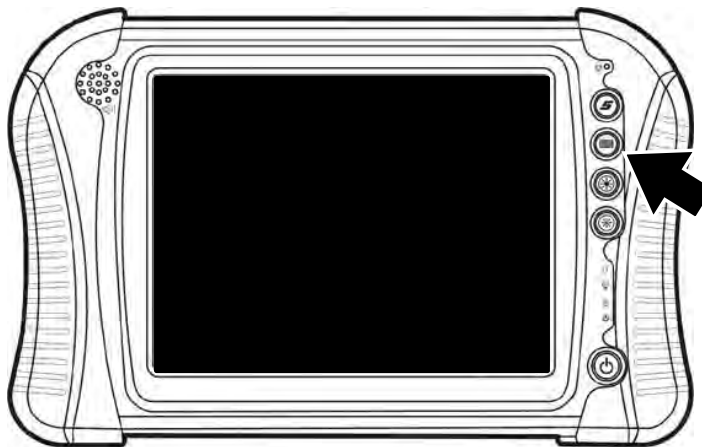

Figure 3-3 Virtual Keyboard button and system tray icon



1— **Settings icon** - opens the Virtual Keyboard settings window ([Figure 3-5](#))

2. **Expand icon** - expands the Virtual Keyboard to full display (press again to return to standard display)
3. **Top** - moves the keyboard to top of screen
- 4— **Close** - closes the keyboard
- 5— **Bottom** - moves the keyboard to bottom of screen

Figure 3-4 Virtual Keyboard (shown expanded)



NOTE:

The Virtual Keyboard can be set to open automatically, when a data field or form is selected in certain applications. See the Settings window (Figure 3-5) for selection options.



Figure 3-5 Virtual Keyboard settings window

3.5 Wi-Fi Setup

Certain applications in the ShopStream Diagnostic Suite require wireless Internet connection. The wireless network connection status icon is typically available from the Windows system tray and can be used to access the wireless network connection setup. Refer to Windows user documentation for wireless network setup instructions.

The Scanner function allows you to establish a data link to the electronic control systems of the vehicle being serviced to retrieve diagnostic trouble codes (DTCs), view live data parameters, and perform tests. The Scanner function can access the electronic control module (ECM) for various vehicle control systems such as engine, transmission, antilock brake system (ABS) and more.

Scanner and OBD-II testing requires connecting the Diagnostic Tool to the test vehicle using the data cable and test adapters and/or Scan Module (depending on version). Onscreen data cable connection instructions are provided. Additional connection information can be found in the appropriate vehicle communication software manual for the test vehicle, which is available through the Help menu.

This section includes information and instructions on the following topics:

- [Demonstration Program](#) - learn the basics, using the built-in demonstration program
- [Basic Operation and Navigation](#) - become familiar with Scanner icons and menu navigation
- [Scanner Operation](#) - follow along with step-by-step basic vehicle scanning operations
- [Stopping Communication and Exiting the Scanner](#) - review important Scanner exiting procedures

4.1 Demonstration Program

A Scanner demonstration program is provided to help you to become familiar with Scanner operations, without connecting to a vehicle. Sample data and test results are provided to help you learn the menus and basic operations.

IMPORTANT:

Do not connect the Scan Module to a vehicle while using the Demonstration mode.

**Using the demonstration program:**

1. From the Home screen, select the **Scanner** icon to open the manufacturer menu.
The manufacturer menu includes all makes for which Scanner information is available. There is also a Demonstration icon included in the list.

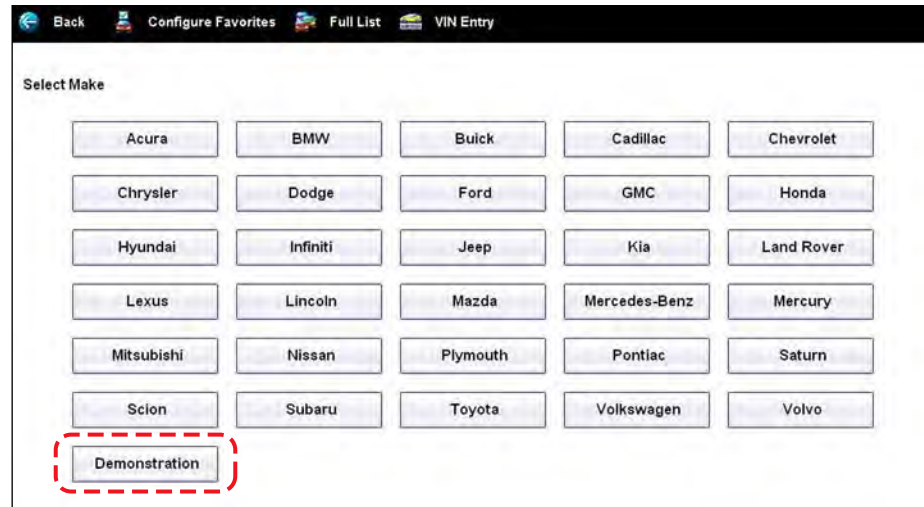

Figure 4-1 Sample demonstration selection

2. Select the **Demonstration** icon.
 - A menu of demonstration choices now displays:
 - **US Domestic**—contains actual data captured while driving a vehicle.
 - **OBD Training Mode**—provides simulated data for an OBD-II/EOBD vehicle that allows you to access any of the standard functions.
3. Select either option and a confirmation message displays.
4. Select **OK** to load the selected database.
5. Follow the on-screen instructions and select as needed until the Systems menu displays.
6. Select from any of the systems listed, then select from the submenus.

4.2 Basic Operation and Navigation

This section describes the basic menus, controls and navigation of the Scanner function and select scanner tests.

4.2.1 Screen Messages

Screen messages appear when additional input is needed before proceeding. There are three types of on-screen messages; confirmations, warnings, and errors.

- **Confirmation Messages** - Confirmation messages inform you when you are about to perform an action that cannot be reversed or when an action has been initiated and your confirmation is needed to continue. When a user-response is not required to continue, the message displays briefly before automatically disappearing.
- **Warning Messages** - Warning messages inform you when completing the selected action may result in an irreversible change or loss of data.
- **Error Messages** - Error messages inform you when a system or procedural error has occurred. Examples of possible errors include a disconnected cable or a peripheral, such as a printer, is powered off.

4.2.2 Making Selections

The Scanner interface is a menu driven program that presents a series of choices one at a time. As you select from a menu, the next menu in the series displays. Each selection narrows the focus and leads to the desired test. Use your fingertip or the stylus to make menu selections.

4.2.3 Scanner Screen Layout

The Scanner screens typically include three sections (Figure 4-2):



- 1— Scanner Toolbar
- 2— Main Body
- 3— Lower Toolbar

Figure 4-2 Scanner screen layout







Scanner Toolbar

The Scanner toolbar contains a number of icons that allow you to configure the displayed data and to exit. The table below provides a brief explanation of the Scanner toolbar icon operations:

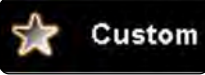
Table 4-1 Scanner toolbar icons (sheet 1 of 2)

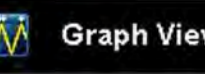
Name	Icon	Description
Exit		Closes the current test and returns you to the menu.
Back		When available, returns to the previously viewed screen.

Table 4-1 Scanner toolbar icons (sheet 2 of 2)

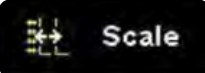
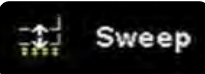
Name	Icon	Description
Custom	 Custom	Allows you to select which parameters are displayed on the screen.
Alarms	 Alarms	Allows you to set an alarm on certain data parameters when the signal goes above or below the alarm setting.
Properties	 Properties	Allows you to adjust the display characteristics for all of the data screens.
Graph View	 Graph View	Allows you to simultaneously view up to 16 data graphs at a time.
Save	 Save	Saves a copy of the current frame of data that can be viewed using Data Manager.
Print	 Print	Opens a standard Windows Print dialog box for saving a print copy of the current frame of data.
More	 .more...	Opens a dropdown menu of the additional options shown below.
Scale	 Scale	Switches the scale values, displayed along the left-hand side of the graphs, on and off.
Sweep	 Sweep	Switches the sweep values, displayed at the base of the graphs, on and off.

The Scanner toolbar is used to configure certain aspects of the displayed data and to exit. The following sections explain how to use the toolbar.

Custom

The **Custom** icon on the Scanner Toolbar is used to determine which specific parameters display. Minimizing the number of parameters on the data list allows you to focus on any suspicious or symptom-specific data parameters. You can add or remove most parameters from the list. Any parameter that has a lock icon next to it cannot be removed from the list.

IMPORTANT:

Limiting the number of parameters that display allows for a faster refresh rate of the data. A smaller data lists also reduces the amount of memory used for saved files.



To create a custom data list:

1. Select **Custom** on the Scanner Toolbar.
The parameter selection dialog box with all of the parameters selected opens ([Figure 4-3](#)).
2. Select the **Deselect All** icon to clear the highlights from the screen.
3. Create a custom data list by selecting the parameters to be included. Highlighting indicates a parameter that displays, parameters that are not highlighted do not display.



Figure 4-3 Sample custom configuration screen

Keep the following in mind when configuring a custom data list:

- Gesture scroll if the list of parameters is longer than what is shown on the screen.
 - Use the **Select All** icon to display the complete list.
 - Use the **Deselect All** icon to remove all the currently selected parameters from the list.
 - Select individual parameters to highlight and include them in the list.
 - Select individual highlighted parameters to remove them from the list.
 - Use the **Cancel** icon to return to the data display.
4. Once all desired parameters have been selected, return to the data list:
 - Use the **List View** icon to return to a data screen in PID List format.
 - Use the **Graph View** icon to return to a data screen in Graph View format, see [Graph View](#) on page 27 for details.



NOTE:

Graph View is only available when 16 or fewer parameters (the number that can display on a single screen) were selected for the custom list. Make sure that no more than 16 parameters are highlighted if the screen displays a single graph when the Graph View icon is selected.

Alarms

Alarms are visual indicators alongside a parameter in the data display list that change color to show the signal status. A green alarm indicates on, a gray alarm indicates off. Only digital parameters, those with a range limited to two states, can have alarms. Parameters with continuous ranges, such as variable voltage and pressure values, cannot have alarms. The alarm indicator assignments remain as selected until you exit the data list:



To configure alarm settings:

1. Select the **Alarms** icon on the Scanner Toolbar.
The Alarm List dialog box opens.
2. Check the parameters that you want to show alarms.
3. Select **Save**.

Alarm indicators now appear next to the selected parameters in the Data List ([Figure 4-4](#)).

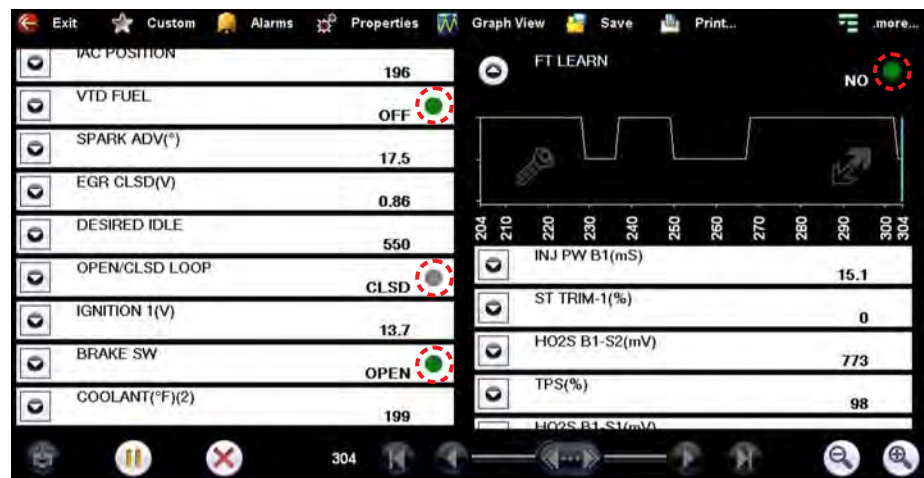

Figure 4-4 Sample alarm indicators



NOTE:

Alarms can only be set for certain parameters. If the Alarm List dialog box is empty, no parameters are available and alarms cannot be set.

Properties

The **Properties** icon on the Scanner Toolbar is used to configure certain characteristics of the parameter graph display. Selecting opens a Properties dialog box that allows you to adjust colors, settings, and sweep (Figure 4-5).



Figure 4-5 Sample properties dialog box

Selecting either color option, **Edit Plot Color** or **Edit Background Color** opens a standard color selection dialog box. Select a color, then select **OK** to close the dialog box.

The Show Grid icon is used to switch a background grid pattern on the data graphs on and off:

- To switch the grid on; select to highlight **Show Grid**, then select **Accept**.
- To switch the grid off; select **Show Grid** twice so it is not highlighted, then select **Accept**.

The Samples After Trigger setting determines how many data samples are recorded following a triggering event. The highlighted samples icon indicates the number of frames that are included in the recording after a triggering event.

The sweep options let you choose the amount of data that displays across the graph. Values are in sample points, or frames of data. A frame of data equals one complete transmission of the serial data by the electronic control module.

Graph View

Graph View allows you to simultaneously display up to 16 parameter graphs (Figure 4-6). The graphs must first be opened in the data list in order to be included when **Graph View** is selected from the toolbar. The display defaults to a single graph if more than 16 graphs are open when the toolbar icon is selected. Should this happen, return to the data list and close some of the graphs.

A toolbar in Graph View allows you switch scale and sweep values on and off, and to return to the List View. The Data Buffer toolbar at the base of the screen remains active.



NOTE:

The screen does not scroll in Graph View mode, it adjusts to show only the selected parameters.



Figure 4-6 Sample Graph View screen

Graph View mode can also be engaged from the custom data list configuration screen. Refer to [Custom](#) on page 23 for details.



To use Graph View:

1. Open the graph for each data parameter, up to sixteen, that you wish to view.
2. Configure parameter settings, such as Triggers, Auto Scale, and Sweep, as needed. Remember, these must be selected before entering Graph View.
3. Select **Graph View** on the Scanner toolbar.
All of the open data graphs now appear on a single screen (Figure 4-6).
4. Select **List View** on the Scanner toolbar to return to a normal view.

Save

The **Save** icon is used to record movies of vehicle datastream values. Saved files can be helpful when trying to isolate an intermittent problem or to verify a repair during a road test.



To save a movie:

- Select **Save**.

A save movie dialog box displays while data is being saved. The movie is saved when the message box disappears.



Figure 4-7 Sample save dialog box

To open saved Scanner data files, from the Home screen select **Data Manager > Scanner Data Folder**, see [Scanner DataViewer Operation](#) on page 132.

Print

Selecting **Print** from the toolbar opens a standard Windows Print dialog box. Select from the options as needed to print the current frame of data.

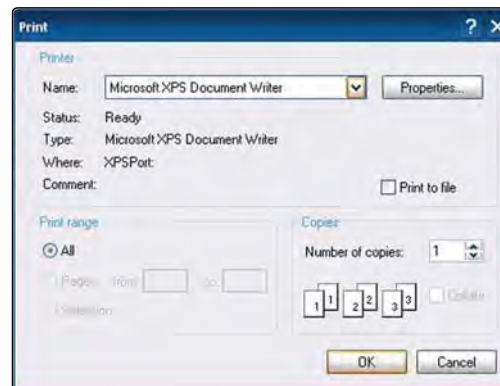

Figure 4-8 Sample print dialog box

If the Diagnostic Tool is connected to a printer, the current frame of data is printed. If the Diagnostic Tool is not connected to a printer, the frame of data is saved as an “XPS” file. A dialog box opens

so that you can name the print file and specify the location that it is saved to, follow the on-screen instructions.

Saved files can be printed at a later date, or opened and reviewed.



NOTE:

Saved print files cannot be viewed using the Data Manager, they can only be opened into an internet browser.



To open a saved print file:

1. Minimize the Diagnostic Suite to view the desktop.
2. From the desktop select **My Documents > ShopStream > Scanner Data Folder**.
3. Locate the file you wish to view.
4. Double select the file to open it.
The internet browser and file open.

More

Whenever the More icon appears on the toolbar it indicates that there are additional options available. Selecting the **More** icon from the Scanner toolbar opens a dropdown menu that offers two choices that only apply to data graphs:

- Scale
- Sweep

Scale

The **Scale** option switches the scale values, displayed along the left-hand side of the data graphs, on and off (Figure 4-9). The dropdown menu closes once a selection is made.

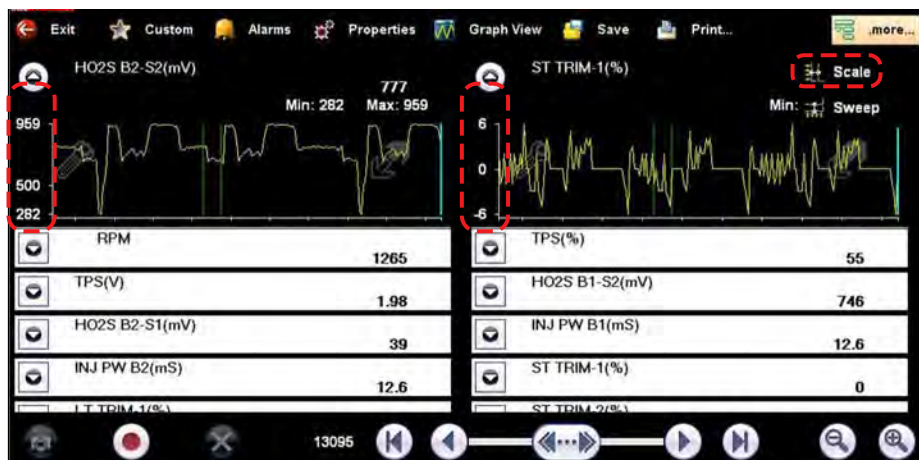

Figure 4-9 Sample data graph scales

Sweep

The Sweep option switches the sweep values, displayed below the data graphs, on and off (Figure 4-10). The dropdown menu closes once a selection is made.

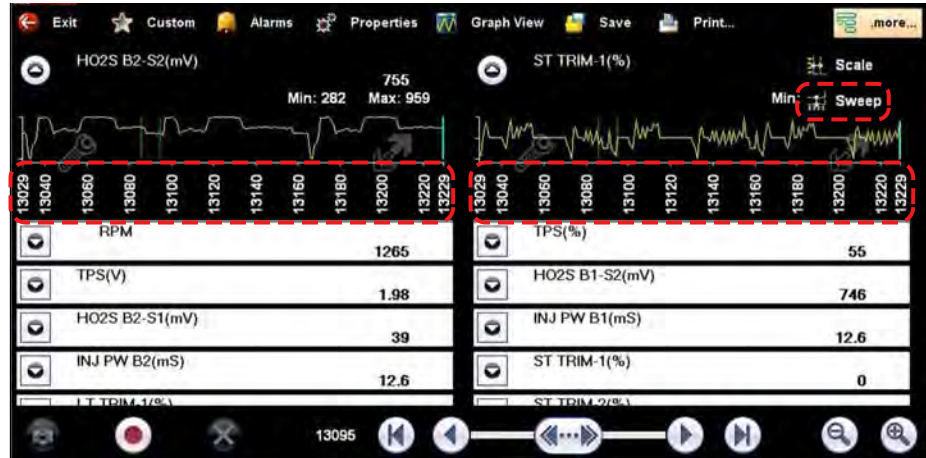

Figure 4-10 Sample data graph sweep

Main Body

The main body of the screen varies depending on the stage of operation. The main body can show vehicle identification selections, the main menu, test data, instructions, troubleshooting information, controls, and other diagnostic information.







Lower Toolbar

Whenever communication is established with a vehicle, the Scanner continuously records data transmitted by the ECM in the data buffer. The toolbar below the main body of the screen contains the icons for navigating the buffered data and other options (Table 4-2).

Table 4-2 Data buffer toolbar icons (sheet 1 of 2)

Name	Icon	Description
Snapshot		Arms the software to take a snapshot of vehicle data
Go To Start		Moves to the first frame in the data buffer
Pause		Suspends data capture and changes to show the Play icon
Play		Starts or resumes data capture and changes to show the Pause icon

Table 4-2 Data buffer toolbar icons (sheet 2 of 2)

Name	Icon	Description
Go To End		Moves to the last frame in the data buffer
Clear		Erases data in the data buffer
Step Back		Moves to the previous frame in the data buffer
Frame Counter		Indicates the data buffer frame currently displayed
Step Forward		Moves to the next frame in the data buffer
Zoom In		Increases the magnification by decreasing the sweep of the graph
Zoom Out		Decreases the magnification by increasing the sweep of the graph

Use the slider in the middle of the toolbar to quickly move through paused data.



Figure 4-11 Sample data buffer slider

4.2.4 Menu Options

The Toolbar Menu icon at the base of the screen opens a menu near the top of the display.

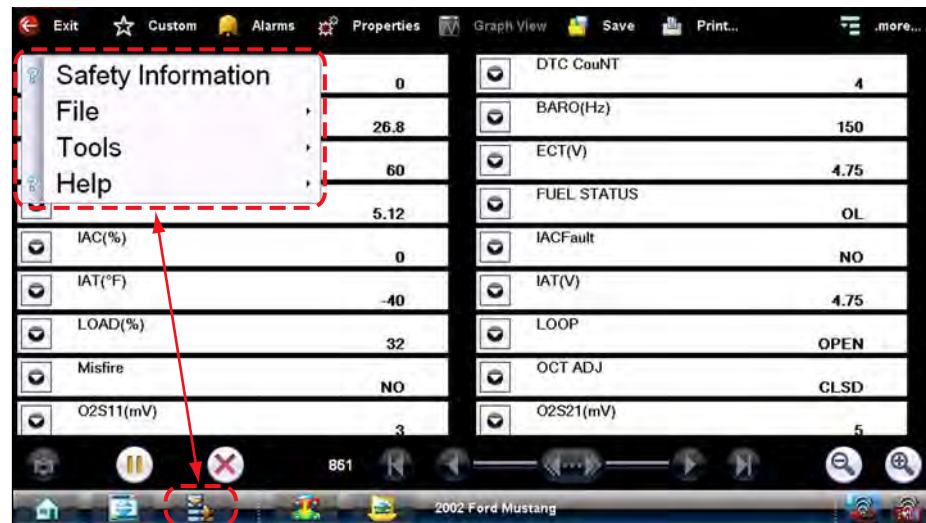

Figure 4-12 Sample Scanner Menu icon options

The following Menu options are available:

- [Safety Information](#)—opens the *Important Safety Instructions* document.
- [File](#)—allows you to print or save the data being viewed.
- [Tools](#)—allows you to perform certain maintenance operations and adjust tool settings.
- [Help](#)—allows you to view supporting documentation.

File

Use to print or save a copy of the data currently being viewed. Menu options include:

- **Save**—opens a submenu with these options:
 - **Screenshot**—saves a graphic image of the current screen.
 - **Collected Data**—saves a recording of all the data currently in the buffer plus the number of frames designated after the trigger event (see [Properties](#) on page 26).
- **Print**—opens a submenu with these options:
 - **Screen**—sends the current screen image to a printer.
 - **Troubleshooter**—prints the full text of the troubleshooter topic shown in the main body.

Selecting an option opens a Windows Print dialog box for printing or saving the file.

Tools

This option allows you to adjust tool settings to your personal preferences. Selecting **Tools** opens a menu with two options:

- [Units Setup](#)
- [Display BEN](#)

Units Setup

The units of measurement can be changed for temperature, vehicle speed, air pressure and other pressure readings. Choose between US customary or metric units of measure.



To change the units setup:

1. Select **Tools > Units Setup**.

The Measurement Units Setup dialog box opens.

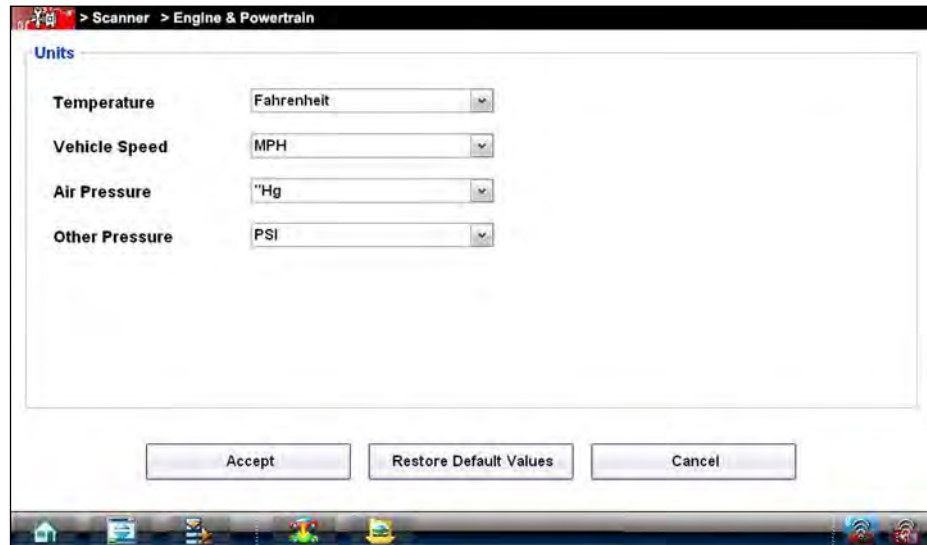

Figure 4-13 Sample Units Setup screen

2. Use the dropdown menus to select the desired value for each item.
3. Select **Accept** to close the dialog box and apply the changes.

Display BEN

Selecting opens a screen with the Balco Engine Number (BEN) of the currently identified vehicle. The BEN is used internally for data coordination, and you may be asked to provide to a Customer Care representative for troubleshooting communication problems.

Help

A variety of utilities and additional resources are available through the Help menu:

- [User's Manuals](#)
- [About Scanner Hardware Version](#)
- [About Scanner](#)

The User Manual, Version Info, and Activation Status options are the same as explained previously, see [Menu Options](#) on page 32 for details. Other options are explained below.

User's Manuals

This option opens a menu of additional support documentation, such as vehicle communication software manuals, available to assist in your diagnosis. These manuals provide connection information, detailed test procedures, and other resource material for specific vehicles.

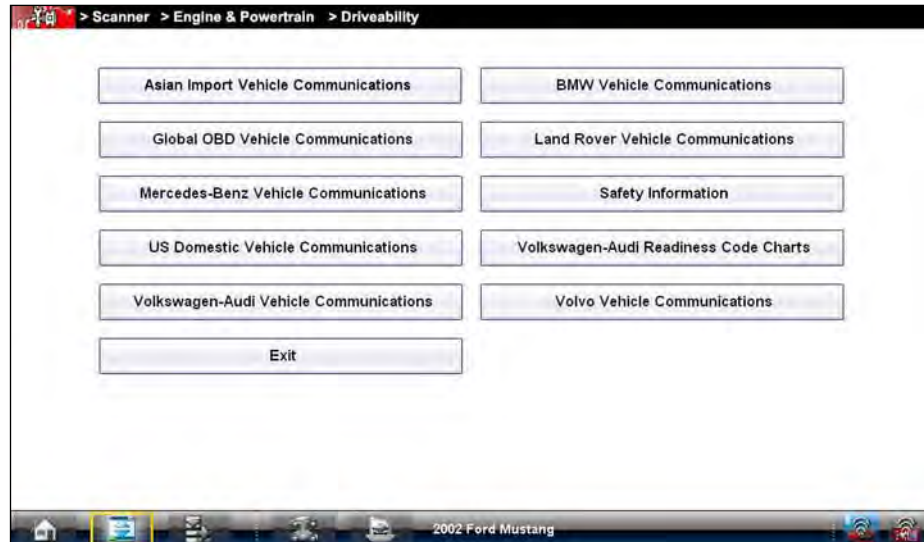

Figure 4-14 *Sample User's Manuals menu*

Select **Exit** to close the Help module and return to the Scanner.

About Scanner Hardware Version

This option opens a dialog box showing the hardware version and other details about the Scanner module. A **Copy to Clipboard** icon allows you to paste the information to a document or e-mail.

About Scanner

This option opens a dialog box that shows the software version and other Scanner module details. A **Copy to Clipboard** icon allows you to paste the information to a document or e-mail.

4.3 Scanner Operation

The Scanner function communicates with vehicle control modules, to provide you with DTCs, parameter data (PIDs), applicable functional tests, and troubleshooting information.:



Basic Scanner Operation Steps

**NOTE:**

Menus, options and procedures may vary by vehicle.

1. If needed, turn the diagnostic tool on.
2. Connect the data cable to the vehicle and to the Scan Module. **Note:** The wireless Scan Module must be paired to the diagnostic tool to communicate. See [Pairing The Scan Module](#) on page 55.
3. Turn the vehicle ignition switch on.
4. Select **Scanner** from the Home screen.
5. Depending on the vehicle, Instant ID may occur. See [Instant ID](#) on page 36 for additional information.
 - a. If Instant ID is not supported, after selecting vehicle year and make, choose Auto or Manual ID and enter the vehicle information at the screen prompts to continue.
6. Select a **System** to test. **Note:** If the Scan Module is not connected, an onscreen message may appear providing connection instructions.
7. Select a **Test** to be performed.

Note: The above information applies to most OBD-II vehicles. Not all vehicles support Instant ID.

4.3.1 Connecting the Scan Module

The Scan Module is a wireless device that is connected (using the vehicle data cable) to the vehicle and transmits vehicle data to the Diagnostic Tool. To use the Scanner function the Scan Module must be paired with the Diagnostic Tool. If the Scanner tries to communicate with the vehicle and the Scan Module is not connected to the vehicle, a Connect Data Cable confirmation screen will display. For Scan Module connection and operation information, see [Pairing The Scan Module](#) on page 55.

4.3.2 Vehicle Identification

Connection of the data cable and Scan Module to the diagnostic tool and vehicle DLC is required for Scanner testing.

Vehicle identification is the initial step in using the Scanner function. Once vehicle identification information is entered it is saved in Vehicle History and can be selected again for later use to save time when testing the same vehicle.

**NOTE:**

Menu options and procedures may vary by vehicle.

Instant ID

Instant vehicle identification is a built-in (default) Scanner feature that will save you time when identifying a vehicle, by automatically communicating with the vehicle to complete the vehicle identification process. Depending on the vehicle, Instant ID may occur automatically and only ask you to confirm the vehicle, or additional screen prompts may be displayed to enter vehicle information.

To complete the Instant ID process and continue, select **Continue** from the vehicle confirmation screen.

Manual ID

If Instant ID is not supported, the vehicle identification must be manually entered. The vehicle identification sequence is menu driven, follow the screen prompts to enter the vehicle information.

To complete the Manual ID process and continue, select **Continue** from the vehicle confirmation screen.



Identifying a vehicle:

1. Select the **Scanner** from the Home screen.
A list of vehicle manufacturers (make) displays ([Figure 4-15](#)).

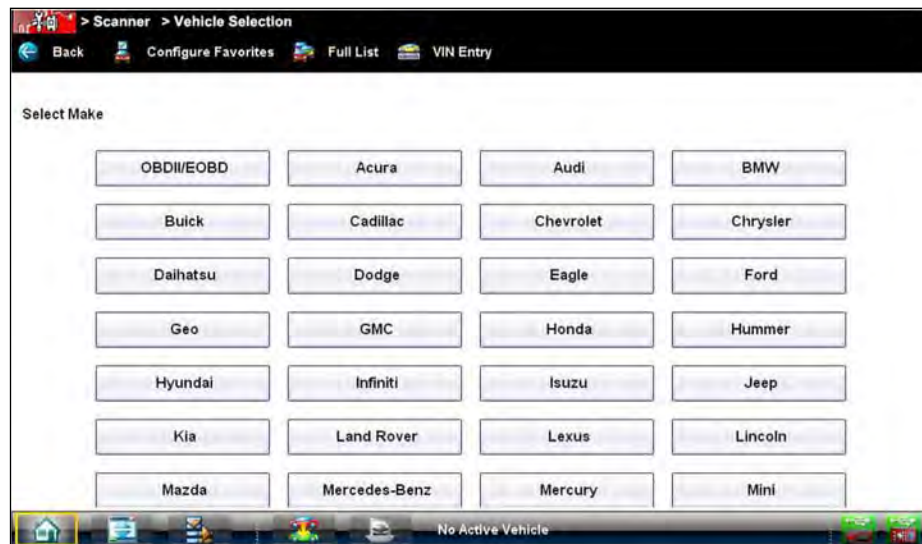

Figure 4-15 Manufacturer list (typical)

2. Select a manufacturer from the list.
A model year menu displays.



NOTE:

You can limit the number of manufacturers that appear on the list by selecting **Configure Favorites** from the toolbar. See [Creating a Favorites List](#) on page 78 for details.

3. Select the vehicle year.

A list of vehicle types or models displays. Several selections may be required to identify the vehicle type and model, follow the screen prompts and enter the required information.

A confirmation page showing the identified vehicle displays once all the required data has been entered. Review the information to make sure it is correct.

4. Select **OK**.

Alternative Vehicle Identification

Occasionally, you may try to identify a test vehicle that the Scanner does not recognize, the database does not support, or has some unique characteristics that prevents it from communicating with the Scanner. In these instances, there is an alternate choice that allows you to establish communication with the vehicle:

- **OBDII/EOBD Function**—this function allows you to connect to the OBDII equipped vehicle and perform basic OBD-II or EOBD diagnostic functions, see [OBD Direct Operations](#) on page 67 for additional information.

4.3.3 Vehicle System Selection



Selecting a vehicle system:

1. After the vehicle has been identified, a list of available systems for testing displays ([Figure 4-16](#)). Select a system to continue.

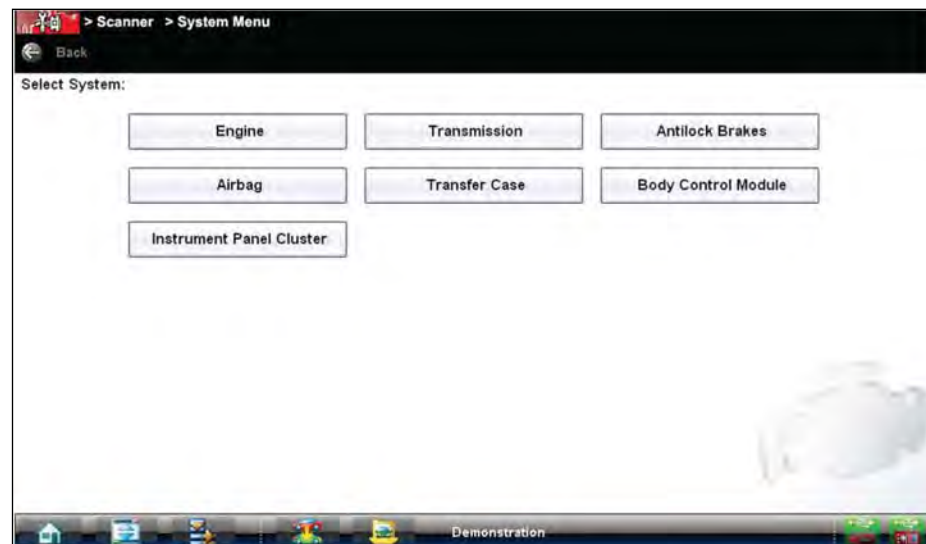

Figure 4-16 Systems menu

Code Scan Option (Systems Menu)

**NOTE:**

Depending on the vehicle, the Code Scan option may be available from the systems menu (Figure 4-17).



Figure 4-17 Systems Menu - Code Scan

Code Scan is used to scan all available vehicle control modules for DTC's at once. This time saving feature displays the following information progressively as the modules are scanned.

- The total number of systems detected
- A summarized list of modules detected with DTCs totals for each
- Individual system module reports that include a list of the DTCs set, the DTC common replaced parts graph and a direct link to SureTrack[®] Fix It! information for each specific DTC. For additional information on SureTrack, the Fix It! and common replaced parts graph features see [SureTrack](#) on page 150.

**NOTE:**

SureTrack information is optional, and is displayed when SureTrack is activated and if data is available for a selected DTC.

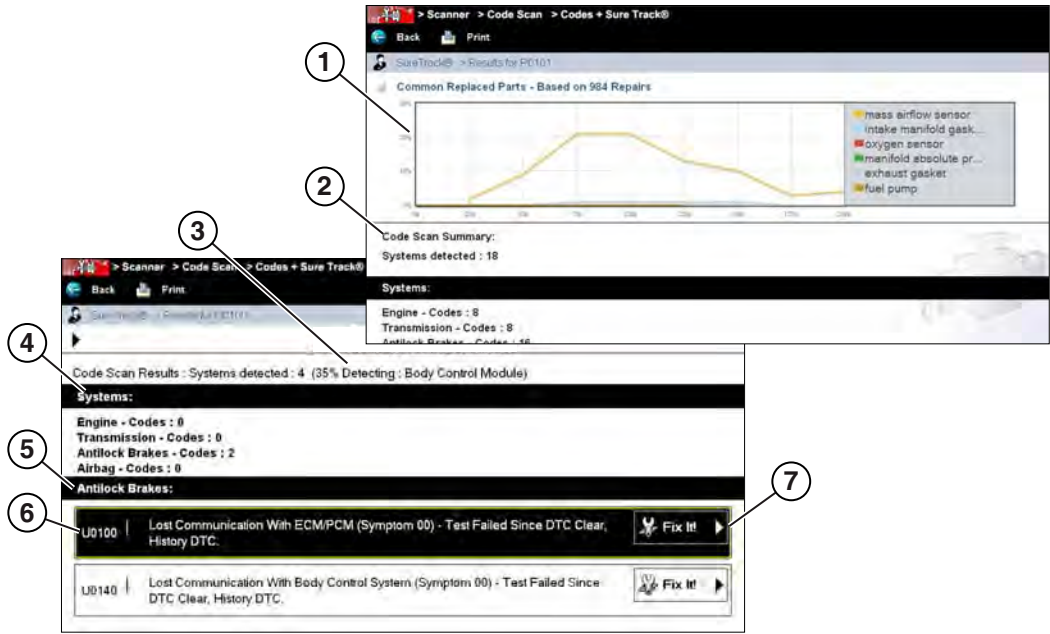

Figure 4-18 Code Scan Features

- 1— SureTrack Common Replaced Parts Graph
- 2— Code Scan Summary
- 3— Progressive status indicator
- 4— Systems Summary List (with DTC totals)
- 5— Individual System DTC Reports
- 6— SureTrack Fix It! icon

Select **Print** from the toolbar to print the Code Summary Report.

Printed: Monday, November 05, 2016 8:15 AM

2002 Ford Mustang

VIN: —K—T—6—
 Year: 2002
 Make: Ford
 Model: Mustang
 Engine: 4.6L V

Common Reported Faults - Based on 1419 Repairs

Code Scan Summary
 Systems Detected: 18

Systems

- Engine - Codes: 4
- Transmission - Codes: 4
- Antilock Brakes - Codes: 0
- Airbag - Codes: 0
- Body Control Module - Codes: 0
- Door Module - Driver - Codes: 0
- Door Module - Passenger - Codes: 0
- Heating & Air Conditioning - Codes: 0
- Rear Auxiliary Climate Control - Codes: 0
- Rear Heating & Air Conditioning - Codes: 0
- Instrument Panel Cluster - Codes: 0
- Passenger Presence System - Codes: 2
- Radio - Codes: 0
- Seat Module - Codes: 0
- Suspension (ESC) - Codes: 0
- Theft Deterrent - Codes: 0
- Tire Pressure Monitor - Codes: 0
- Transfer Case - Codes: 6

Engine - All Powertrain Codes

- P0101 - Mass Air Flow Circuit Out Of Range
- P0455 - EVAP System Leak (Large)
- P0171 - Fuel System Too Lean Bank 1
- P0420 - Catalyst Efficiency Low Bank 1

Transmission - All Powertrain Codes

- P0101 - Mass Air Flow Circuit Out Of Range
- P0455 - EVAP System Leak (Large)
- P0171 - Fuel System Too Lean Bank 1
- P0420 - Catalyst Efficiency Low Bank 1

Passenger Presence System - Codes

- B1022 - Driver Loop Resistance Low
- B1061 - Lamp Circuit Failure

Figure 4-19 Printed Code Summary Report

Clear All Codes Read by Code Scan

Selecting **Clear All Codes Read by Code Scan** erases all DTCs from all vehicle system modules that were read by Code Scan.

4.3.4 Vehicle Test Selection



Selecting a vehicle test:

1. After a system is selected and the Scanner establishes communication with the vehicle, the Scanner Main menu displays available tests. Select a menu item to continue.

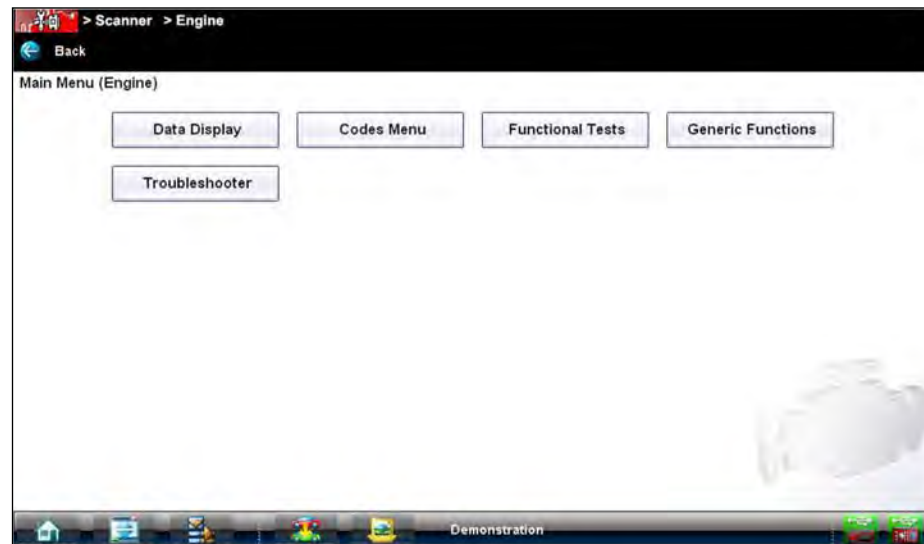

Figure 4-20 Scanner Main menu

Main menu options vary slightly by year, make, and model. The main menu may include:

- **Data Display**—displays data parameter information from the vehicle electronic control module (ECM). Selecting may open a submenu of viewing options.
- **Codes Menu**—displays diagnostic trouble code (DTC) records from the vehicle electronic control module. Selecting may open a submenu of viewing options.
- **Clear Codes**—erases DTC records and other data from the ECM. This selection is found on a Codes submenu for some models.
- **Functional Tests**—provides specific subsystem and Guided Component Tests. The tests vary depending on the manufacturer and model.
- **Actuator Tests**—similar to functional tests, checks the operation of certain actuators, such as solenoid valves and relays.
- **Memory Resets**—allows you to reprogram adaptive values for certain components after making repairs. Selecting opens a submenu. These options are found on the Functional Tests Menu for some models.
- **System Tests**—provides specific subsystem testing. Performing these tests is similar to functional tests.
- **Generic Functions**—lets you access certain available Generic OBD II functions from a proprietary menu (1996 and newer vehicles only).
- **Troubleshooter**—provides step-by-step procedures, integrating parameter data and retrieving trouble codes when appropriate, for specific symptoms of the identified vehicle.

Codes Menu

This selection may appear as Codes, Codes Menu, Codes Only, Codes (No Data), or something similar on the menu. Selecting opens a list of data parameter viewing options that may include:

Display Codes

Selecting opens either a list of diagnostic trouble codes (DTCs) stored in the selected electronic control module (ECM), or a submenu of DTC viewing options. Submenu options may include:

- **Trouble Code Information**—opens a list of codes in ECM memory.
- **History Codes**—opens a list of codes whose symptoms are not currently present. History codes indicate an intermittently occurring problem.
- **Failed This Ignition**—opens a list of codes that set during the current ignition cycle.
- **MIL SVS or Message Requested**—displays ECM requests to light the malfunction indicator lamp (MIL) or service vehicle soon (SVS) lamp, or display a driver information alert.
- **Last Test Failed**—displays a complete list of failed tests.
- **Test Failed Since Code Cleared**—displays a list of tests that failed since the last time codes were cleared from ECM memory.

If SureTrack[®] (optional) is active and data is available for a selected DTC, additional troubleshooting information from SureTrack (e.g. Common Replaced Parts data (Figure 4-21), Real Fix and Related Fixes) will also be available. For additional information about using SureTrack, see [SureTrack](#) on page 150.

A code list includes the DTC, a brief description, and a SureTrack **Fix It!** icon that opens a submenu allowing you additional information about the DTC (Figure 4-21).

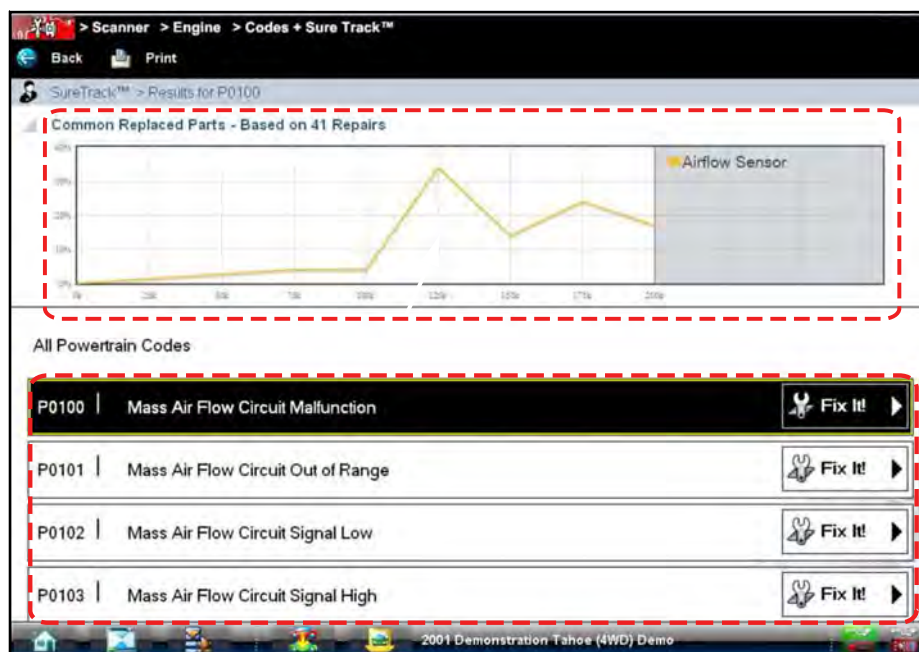

Figure 4-21 Sample code list and SureTrack information

Clear Codes

The Scanner clears trouble codes from the ECM memory on some vehicles. If this function is not available on the test vehicle, Clear Codes does not appear as a menu option.



To clear codes:

1. Select **Clear Codes** from the Codes Menu.
A confirmation message displays.
2. Make sure any conditions shown on the confirmation message are met, then select **Yes**.
A “codes cleared” message displays once the operation is complete.
3. Select **Continue** to return to the Codes Menu.

Freeze Frame/Failure Records

This selection displays the DTC that was set, along with corresponding data, when the ECM commanded the malfunction indicator lamp (MIL) to turn on.

DTC Status

This selection allows you to view the records of a particular DTC.



To check DTC status

1. Select **DTC Status** from the Codes Menu.
The DTC Status entry field displays and the virtual keyboard opens ([Figure 4-22](#)).
2. Use the virtual keyboard to enter the characters of the DTC.
3. Select the virtual keyboard **Backspace** icon if needed to erase a character.
4. Select the virtual keyboard **Return** key once all the code characters are entered.

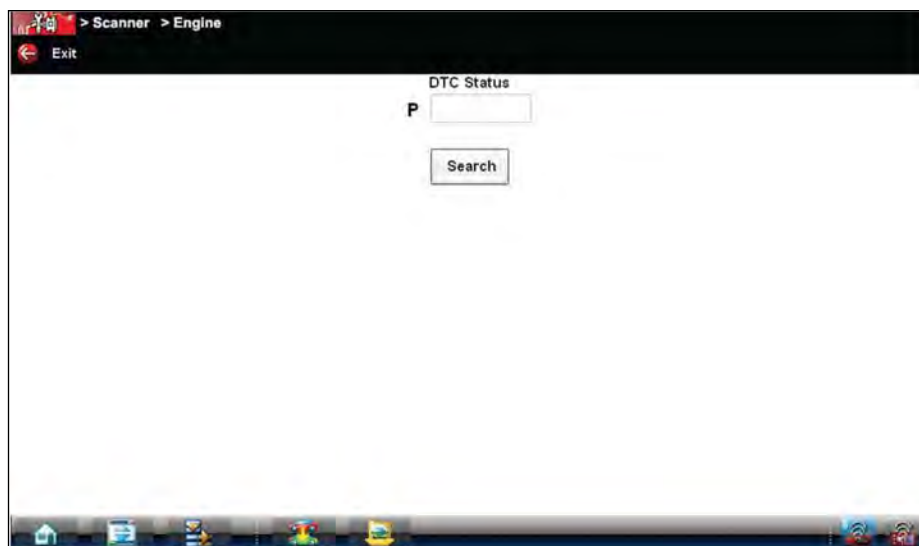

Figure 4-22 Sample DTC Status entry field

The DTC status report displays (Figure 4-23).

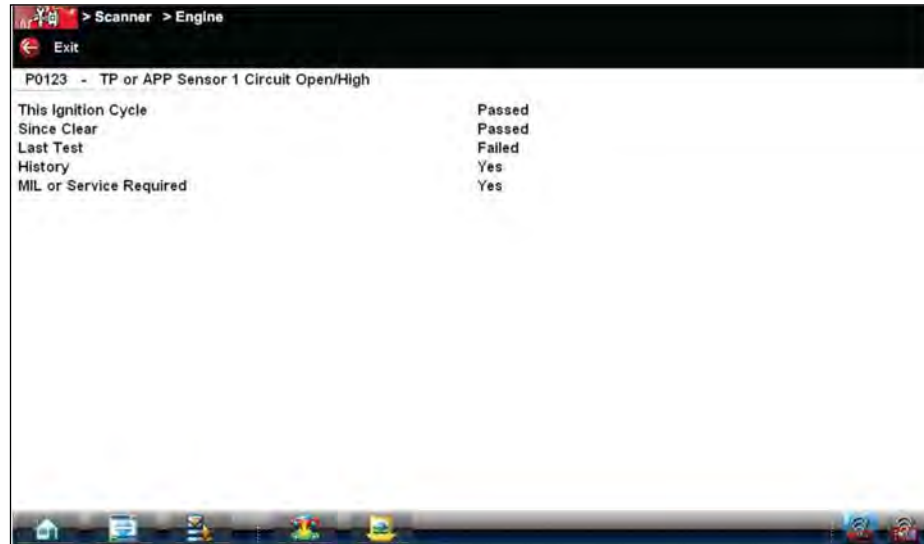

Figure 4-23 Sample DTC status report

5. Select **Exit** to return to the DTC status entry screen.
6. Select **Exit** again to return to the Codes menu.

Data Display

Depending upon the test vehicle, this selection may appear as Data, Data Display, Data Only, Data (No Codes), or something similar. All are similar. Selecting has one of the following results:

- A submenu of data viewing choices displays.
- Vehicle data displays.

A submenu displays when more than one data viewing mode is available on the identified vehicle. On some models, the engine must be started or cranked before data can be displayed. For these models, a "Waiting to Communicate" message displays if the engine was not cranked or started.

Data Screens

When a Data selection is made, the screen displays the data list for the selected module. The items available for any electronic control module vary from one vehicle to another.

Data is presented in a 2-column format. An abbreviated parameter name is at the left of each column and its value is at the right edge of the column. Parameters display in the order that they are transmitted by the ECM, so expect variation between vehicles.

Gesture scrolling allows you to quickly move through the data list. Simply touch the screen and drag your finger up or down to reposition the parameters being displayed. Position bars momentarily appear to the right of each column to indicate the position of the current screen in relation to the entire list as you scroll. Each column of parameters scrolls independently of the other column. Figure 4-24 shows a typical data screen.

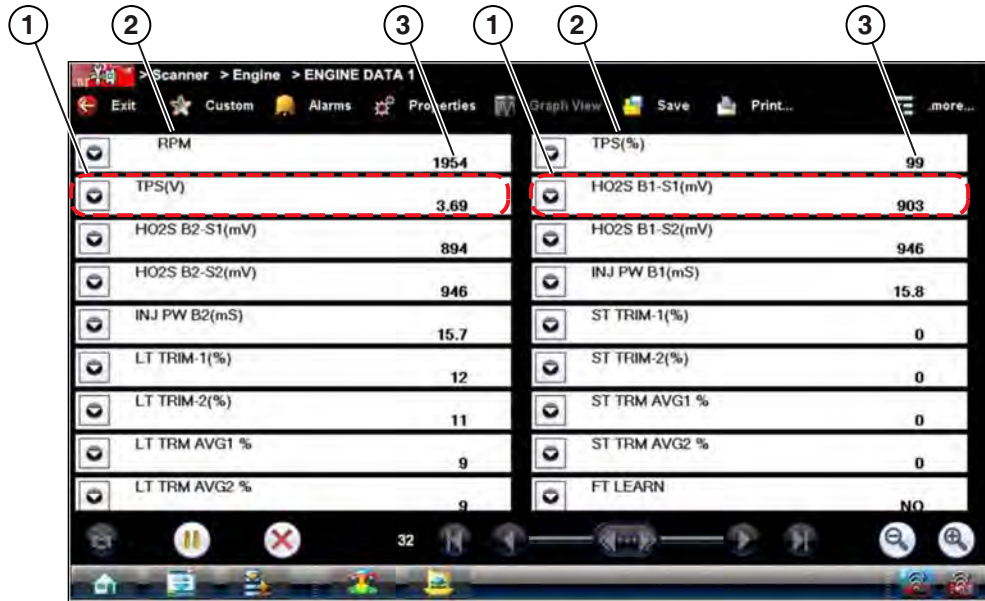

- 1— Graph icon
- 2— Parameter name
- 3— Parameter value

Figure 4-24 Sample data screen

Data Graphs

Select the **Graph** icon to open a data graph for that parameter (Figure 4-25). Selecting a parameter for graph view moves it to the top of the list. Select the **Graph** icon again to close the graph for that parameter and return to a data list view.

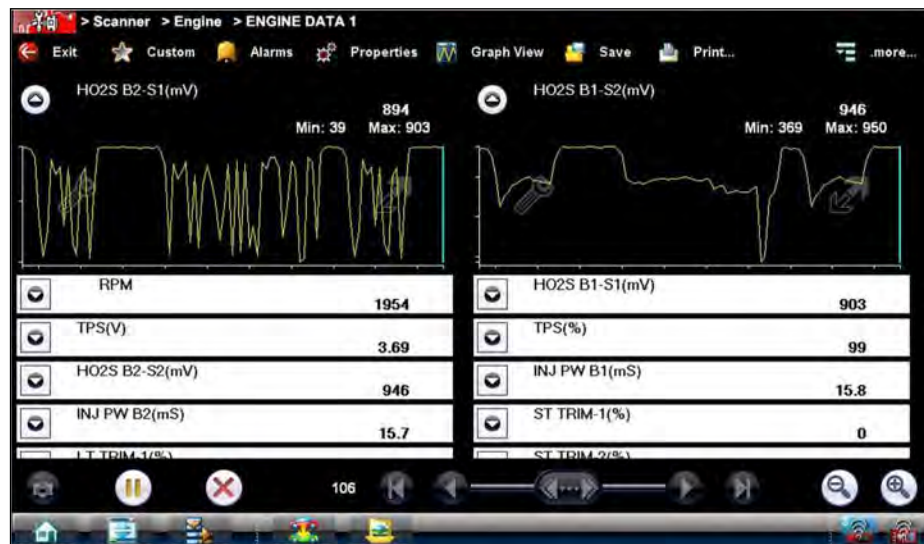



Figure 4-25 Sample graph view

The icons that display on each data graph allow you configure settings for the selected graph only:

Table 4-3 Data graph icon operations

Name	Icon	Description
Expand/Collapse		Select to expand the graph to fill the entire screen, select again to collapse the graph to the standard view.
Graph Properties		Select to open the Graph Properties dialog box, which allows you to set triggers for recording a snapshot and to adjust the scale.

Triggers

Triggers establish threshold values, an upper limit and a lower limit, for recording a data snapshot. A snapshot allows you to closely evaluate conditions that caused the triggering event.

When a snapshot is taken, the Scanner captures additional data after the trigger point is detected, data collection pauses, and the buffered information is automatically saved as a movie. This gives you a complete picture of what was happening before the fact, what occurred at the trigger point, and what happened after the fact.

Data collection is paused following a trigger event. Select the **Play** icon to resume viewing live data. A vertical line now appears on each of the data graphs to indicate the triggering point. The trigger line on the parameter that triggered the snapshot is a different color than those on the other graphs. This makes it easy to determine which parameter caused the trigger when triggers are set for multiple parameters.



To adjust the amount of data collected after a trigger:

1. Select the **Properties** icon on the Scanner toolbar to open the dialog box.
2. Highlight one of the **Samples After Trigger** options:
3. Select the Accept icon to close the dialog box.



NOTE:

You can also adjust the amount of data collected after a triggering event using the Properties icon on the Scanner toolbar. See [Properties](#) on page 26 for additional information.



To set triggers and record a snapshot:

1. Select the Graph Properties icon on the parameter graph you wish to set triggers on.
The Graph Properties dialog box opens.
2. From the Graph Properties dialog box, select **Triggers On**.
A check mark appears in the box and the Min and Max fields activate ([Figure 4-26](#)).
3. Select either **Max:** (maximum) or **Min:** (minimum) to activate that field and open the keyboard.
4. Type the desired trigger value into the field.
5. Select the other field and enter a trigger value, then close the virtual keyboard.
6. Select **Save** to close the dialog box.

Trigger lines (blue for upper and red for lower) display on the selected parameter graph.

The area between the upper and lower trigger lines establishes the triggering condition. Any data points that register outside of the set trigger conditions initiates a snapshot.

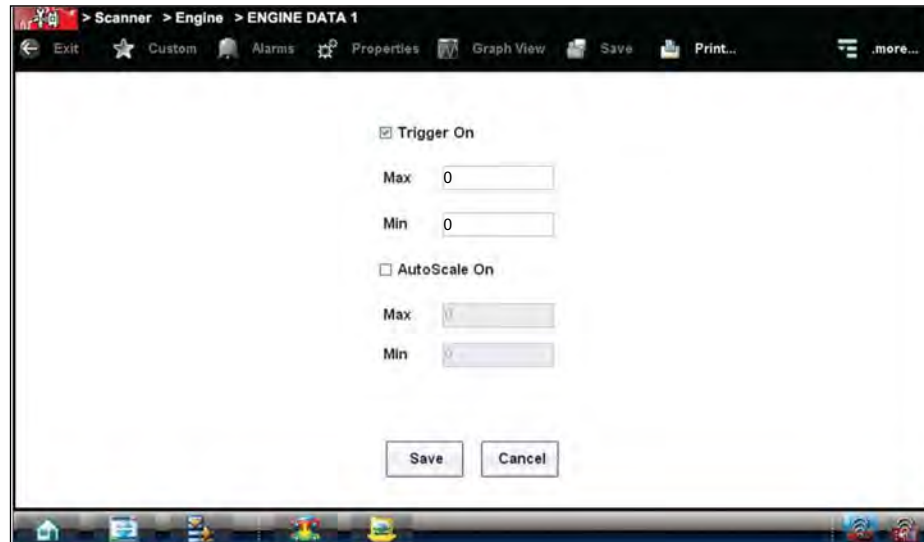

Figure 4-26 Sample Graph Properties dialog box

7. Select **Snapshot** on the Data Buffer Toolbar to arm the snapshot. The Snapshot icon changes color to indicate it has been armed (Figure 4-27).



Figure 4-27 Sample armed Snapshot icon

Once all of the data is compiled, data collection pauses and the information is saved as a movie. A confirmation screen displays to let you know the name automatically assigned to the saved file and where to locate it.

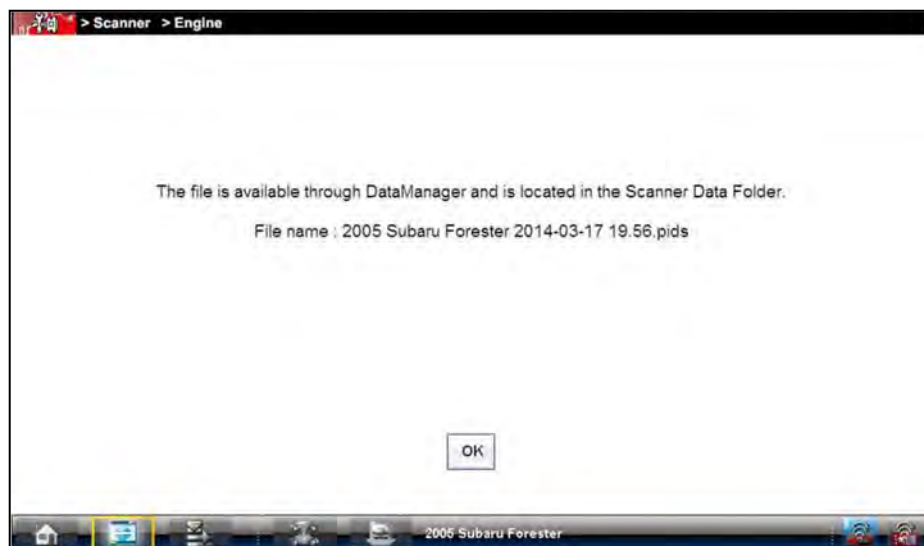

Figure 4-28 Sample saved movie confirmation screen

8. Select **OK** to close the confirmation screen.
9. Select the **Play** icon on the toolbar to resume viewing live data.

**NOTE:**

Selecting an armed Snapshot icon disarms it.

Scale

Scale adjusts the upper and lower values displayed on the vertical axis of a data graph. Two scale modes are available; auto scale and manual scale. Auto scale, which is the default setting, automatically adjusts the graph scale based upon the minimum and maximum values transmitted by the ECM. Manual scale allows you to set the minimum and maximum values.

**To manually set the scale on a graph:**

1. Select the Graph Properties icon to open the dialog box for the graph you wish to scale.
2. From the Graph Properties dialog box (Figure 4-29), select **Auto Scale On**.
The check mark is cleared from the box and the minimum and maximum fields activate.
3. Select either **Max:** (maximum) or **Min:** (minimum) to activate that field and open the keyboard.
4. Type the desired scale value into the field.
5. Select the other field and enter a value, then close the virtual keyboard.
6. Select **Save** to close the dialog box.

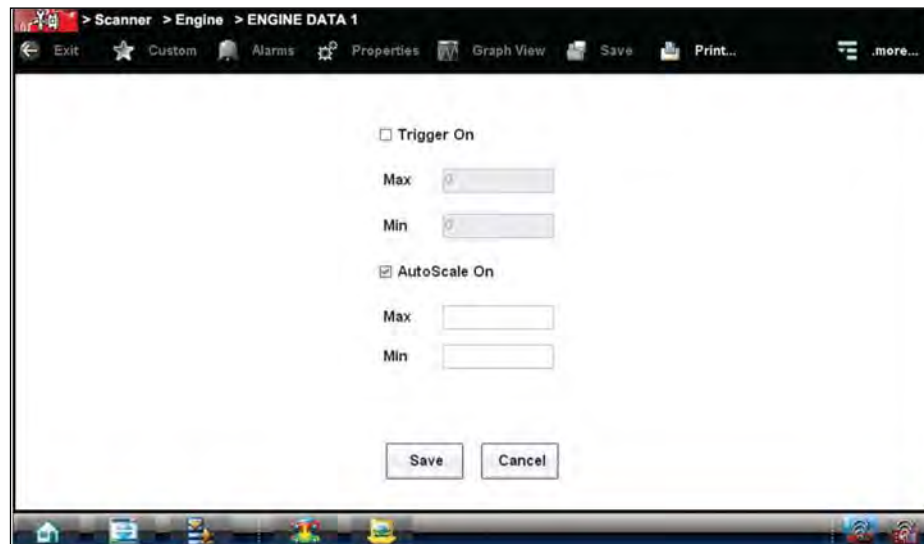

Figure 4-29 Sample manual scale selection

The dialog box closes and the parameter scale is now at the set values.

Using Zoom

The zoom options on the Data Buffer toolbar allow you to change the magnification level of the sweep when viewing data graphs. Use the **Zoom In (+)** icon to increase magnification, and the **Zoom Out (-)** icon to decrease magnification.

Functional Tests

The **Functional Tests** selection is used to access vehicle-specific subsystem and guided component tests. Available tests vary by manufacturer, year, and model, and only the available tests display in the menu.

There are four general types of functional test operations:

- **Information Tests**—are read-only tests, like selecting “VIN” from a Functional Tests menu to display the VIN of the identified vehicle.
- **Toggle Tests**—switch a component, such as a solenoid, relay, or switch, between two operating states.
- **Variable Control Tests**—command a certain value for a system or component, such as varying the spark timing in 1° increments or the EGR valve duty cycle in 10% increments.
- **Reset Tests**—reset the adaptive, or learned, values that are stored in the electronic control module.

Selecting **Functional Tests** opens a menu of test options that varies by make and model. Selecting a menu option either activates the test or opens a submenu of additional choices. Follow all screen instructions while performing tests. How and what information is presented on the screen varies according to the type of test being performed.

IMPORTANT:

Do not enter any functional tests while driving on a road test. During some functional tests, the ECM makes changes to ignition timing, fuel delivery, and other engine functions, which may affect engine operation and vehicle control.

Some toggle and variable control tests display functional test controls at the top of the screen with data stream information below (Figure 4-30).

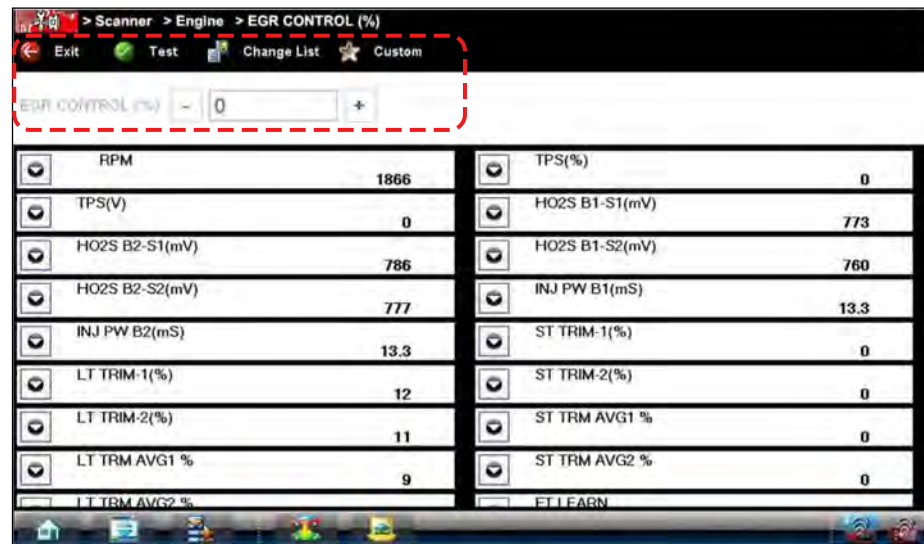

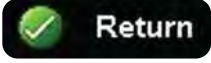

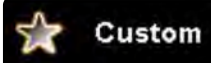



Figure 4-30 Sample functional test controls

Functional test controls allow you manipulate the test signal as shown in the table below. .

Table 4-4 Functional test control icons

Name	Icon	Description
Test		Activates the test.
Return		Moves focus back to the data list.
Change List		Allows you to switch data lists.
Custom		Allows you to select which parameters display during the functional test.
Minus		Switches an item to low or off, or incrementally reduces a variable signal.
Plus		Switches an item to high or on, or incrementally increases a variable signal.

Generic Functions

The **Generic Functions** selection opens a menu of available OBD-II/EOBD functions on 1996 and newer vehicles. For additional information on generic functions refer to the *Global OBD Vehicle Communications Software Manual*. Menu options typically include:

- MIL Status - displays the ID and status of the Malfunction Indicator Lamp (MIL)
- Fast Track[®] Troubleshooter - displays a menu of available experience-based tests and tips
- Readiness Monitors—displays the status of the OBD-II/EOBD required monitors
- (\$01) Display Current Data - displays a screen containing Generic OBD PID data
- (\$02) Freeze Frame—displays data stored in ECM memory when a DTC is set
- (\$05) Oxygen Sensor Monitoring—displays on-board oxygen sensor monitoring test results
- (\$06) On-Board Monitored Systems—displays the status of system monitors
- (\$08) Request Control of On-Board System—establishes bidirectional ECM communication
- (\$09) Calibration Identification—displays the ECM calibration identification numbers
- (\$09) Calibration Verification Number—displays the ECM calibration
- (\$09) In-Use Performance Tracking—displays a monitoring conditions report
- (\$09) Vehicle Identification Number—displays the VIN
- (\$0A) Emissions Related Fault with Permanent Status—displays a record of permanent codes

Troubleshooter

Fast-Track® Troubleshooter is a database of experience-based information of validated real-world repair strategies that have been compiled by top-notch technicians. Troubleshooter simplifies the diagnosis process, as it contains information on virtually all common diagnostic trouble code (DTC) problems and driveability symptoms.

Troubleshooter information is organized into a series of diagnostic tips that are designed to quickly lead you to the root cause of a particular problem. The tips are vehicle-specific, which means only tips that relate to the identified vehicle are presented. Selecting opens a menu that may include:

- **Code Tips**—provides detailed information on setting conditions, testing, and interpreting test results for specific codes.
- **Symptom Tips**—provides diagnostic tests and procedures based on vehicle operation.
- **Time Savers**—provides supplemental information, such as firing order and #1 cylinder location, that may be needed to make a diagnosis.
- **Common Problems**—provides advice and remedies for certain “pattern failures” that have been experienced on vehicles of the same model.
- **Tests and Procedures**—explains how to perform certain tests on the specific test vehicle. Some tips provide specifications and installation information as well.
- **Fast-Track Data Scan (Normal Values)**—contains information and guidelines on how to validate data readings for certain sensors and actuators, live data values are provided.

**NOTE:**

Troubleshooter appears in a Scanner menu only if tips are available for the system selected on the identified vehicle.

Certain live data parameter values display directly within the tip when performing Troubleshooter tests and procedures. A tip may also contain a hyperlink to a Troubleshooter Reference, another test or procedure, or a supplemental operation, such as Clear Codes. Hyperlinks are shown in blue, and selecting them opens the link. Troubleshooter References open in a separate window. (Figure 4-31).

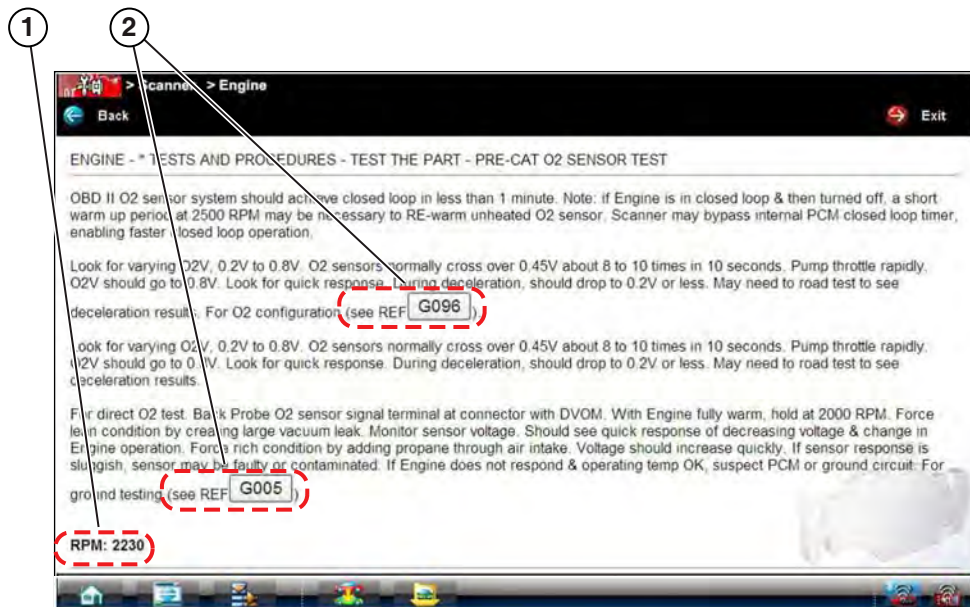

- 1— Live data values
- 2— Hyperlink

Figure 4-31 Sample data values within a Troubleshooter tip

4.4 Stopping Communication and Exiting the Scanner

The Scanner remains open as long as there is an active communication link with the vehicle. You must first stop communication with the vehicle in order to exit from the Scanner function. A warning message displays if you attempt to exit from the Scanner while it is communicating with the vehicle ECM.



NOTE:

Damage to the vehicle electronic control module (ECM) may occur if communication is disrupted. Make sure the data cable and the USB cable are properly connected at all times during testing. Exit all tests before disconnecting the test cable or turning off the tool.

**To exit Scanner and disconnect from a vehicle:**

When disconnecting the Diagnostic Tool from the vehicle, make sure the Scanner software is not communicating with the vehicle.

1. From a codes or data display screen, select the **Exit** icon on the upper toolbar.



Figure 4-32 Exit icon

The screen goes to the codes or data menu.

2. Select the **Back** icon on the upper toolbar.



Figure 4-33 Back icon

The screen goes to the system menu.

3. Select the **Back** icon on the upper toolbar.
A “stopping communication” message briefly displays followed by the systems menu.
4. Select the **Change Vehicle** icon on the Toolbar.



Figure 4-34 Change Vehicle icon

The vehicle description on the toolbar should now read “No Active Vehicle”.

5. Select the **Home** icon on the Toolbar.



Figure 4-35 Home icon

The Home screen displays.

6. Disconnect the data cable from the vehicle diagnostic connector.

This chapter describes the connection, operation, troubleshooting and updating of the Scan Module.

5.1 Overview

The Scan Module is a wireless device that is connected to the vehicle and transmits vehicle data to the diagnostic tool.

The Scan Module operates on 12 or 24VDC vehicle power, supplied through the vehicle's data link connector (DLC).

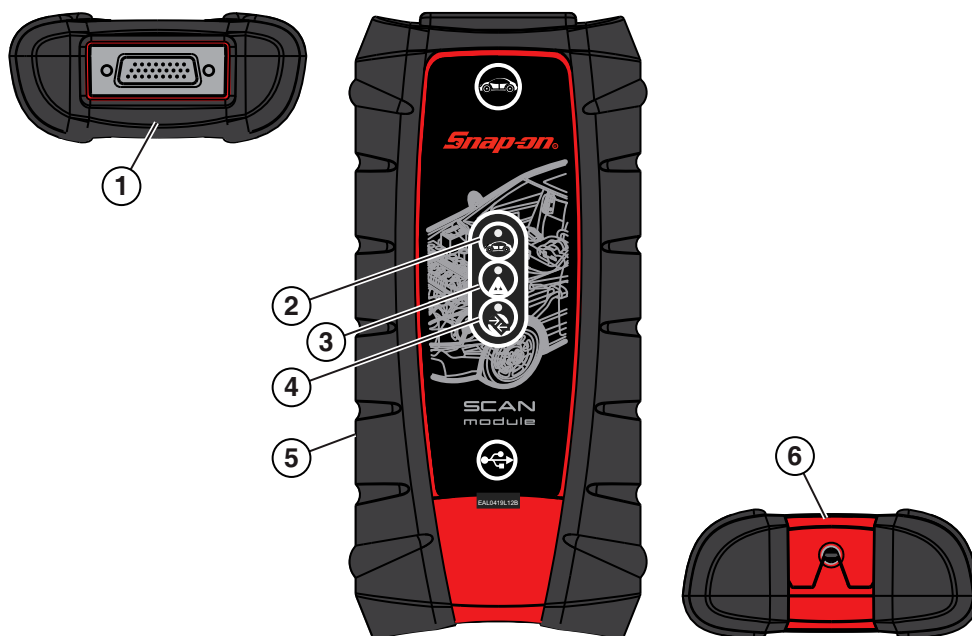

- 1— Data cable connector
- 2— Vehicle power LED (green)
- 3— Communication issue LED (red)
- 4— Bluetooth LED (green)
- 5— Memory card port (remove protective hand grip for access)
- 6— Universal serial bus (USB) jack (remove protective hand grip for access)

Figure 5-1 Scan Module

5.2 Pairing The Scan Module

To use the Scan Module with the Scanner or OBD-II/EODB functions, it must first be paired with the diagnostic tool.

Pairing is the wireless connection (identification) process used to connect the Scan Module to your diagnostic tool.

The Scan Module only needs to be paired once before it's initial use. The connection configuration should remain in memory for all future uses, unless the connection configuration is removed or lost.

**NOTE:**

Wireless devices shown in this section are used as reference. Not all devices shown may be applicable to your diagnostic tool.

**To pair the Scan Module with the diagnostic tool:**

1. Turn on the diagnostic tool.
-

IMPORTANT:

The Scan Module needs to be powered on during the pairing process. Connect the Scan Module to a vehicle or to the diagnostic tool using the USB cable. Make sure the diagnostic tool has a charged battery or is connected to the AC/DC power supply.

2. Connect the 26-pin end of the data cable to the Scan Module data cable connector.
3. Connect the 16-pin end of the data cable to a vehicle data link connector (DLC).
The green LED on the Scan Module is illuminated when power is being supplied to the Scan Module. For additional information on the Data Cable, see [Data Cable Connection](#) on page 57.
4. From the diagnostic tool select **System Settings > Paired Devices**.
5. Select **Add** from the toolbar, then **OK** when prompted.

The diagnostic tool searches for compatible wireless devices, then displays the results. (Figure 5-2).

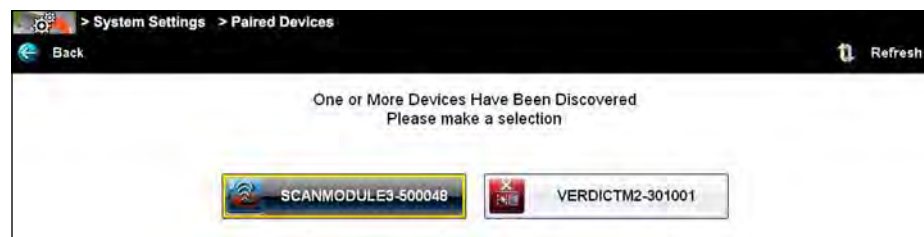

Figure 5-2 Sample Scan Module selection

**NOTE:**

Search results include all compatible wireless devices detected, and may include multiple Scan Modules if you are in a shop environment where more than one unit is powered on. Available module listings include a partial serial number. Make sure the screen listing matches the last six digits of the serial number of your Scan Module before continuing. Scan Module serial numbers are also printed on the back of the Scan Module (e.g. 123SMC-987654)

6. Select the Scan Module you wish to connect from the results list.

A search in progress message displays during the pairing procedure (Figure 5-3), the Paired Devices screen (Figure 5-4) displays once the procedure completes.

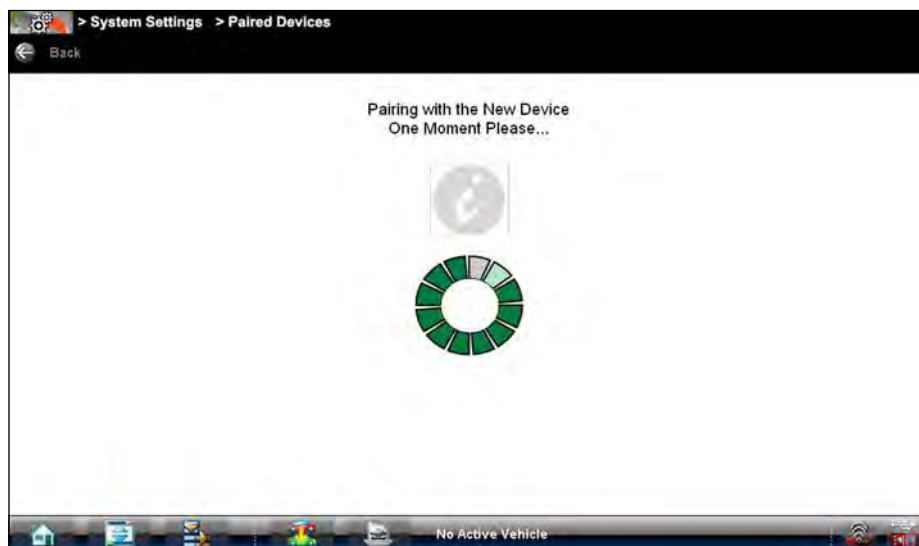

Figure 5-3 Sample pairing in progress message

7. Select the **Home** icon on the Toolbar.
8. Disconnect the data cable from the vehicle.

The Scan Module and diagnostic tool are now paired for wireless communication and should automatically recognize each other when both are powered up.

5.3 Checking Scan Module Paired Status



To check if the Scan Module is paired to your diagnostic tool:

1. Select **System Settings > Paired Devices**.

The paired devices screen opens (Figure 5-4).

The Paired Devices screen lists all of the devices paired to the diagnostic tool, and also indicates whether or not there is active communication occurring.



Figure 5-4 Typical Paired Devices screen

2. Verify the Scan Module is in the list of paired devices.

5.4 Data Cable Connection

To use the Scan Module for Scanner and OBD-II/EOBD testing, it must first be connected to the vehicle's data link connector (DLC).

Depending on the vehicle, the supplied DA-4 data cable may be used alone or may require optional adapters.

- **All OBD-II/EOBD compliant vehicles** - Use the supplied DA-4 data cable. The 26-pin end of the cable attaches to the data cable connector on the Scan Module. The 16-pin end connects to the vehicle DLC. The cable connectors are secured with captive screws.
- **All non-OBD-II/EOBD (OBD-I) compliant vehicles** - Use the supplied DA-4 data cable with the optional DA-5 adapter and a manufacturer specific adapter. The 26-pin end of the cable attaches to the data cable connector on the Scan Module. The 16-pin end connects to the DA-5 adapter, the DA-5 adapter connects to the manufacturer specific adapter and then connects to the vehicle DLC. The cable connectors are secured with captive screws.

While using the Scanner and OBD-II/EOBD functions, on-screen cable and adapter connection instructions are provided. The instructions may also include the location of the vehicle DLC (Figure 5-5). If required, additional connection information can be found in the appropriate vehicle communication software manual for the vehicle. Vehicle communication software manuals are available online, see the website information at the front of this manual.

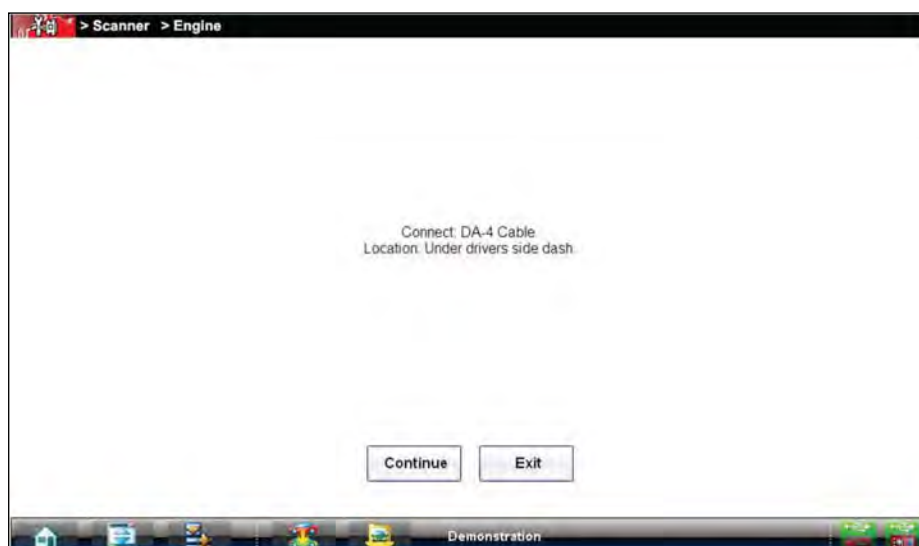

Figure 5-5 Vehicle connection data cable message

For data cable vehicle power connection information, see [Vehicle Power](#) on page 9.



To connect the data cable to the vehicle:

1. While using the Scanner or OBD-II/EODB function, follow the on-screen instructions for connecting the cable and/or any adapters required to the vehicle ([Figure 5-5](#)).
2. Select **Continue** once the data cable is connected to the vehicle.

5.5 Troubleshooting

The Scan Module is a wireless communications device that uses Bluetooth technology to transmit vehicle data to the diagnostic tool without a physical connection. The working range of the transmitter is about 30 feet (9.14 m). Scan Module operations can be impacted when signal interference, or some other condition, disrupts or impairs the wireless communication network. These interruptions are usually temporary and easily repaired.

Indicators of wireless communication interference include:

- Slow Scan Module response accompanied by “Error 101” message.
- Slow Scan Module response accompanied by “Error 404” message.
- “Error Occurred” Message when trying to use the Scan Module.
- “Error Occurred” Message after 20 or more minutes sitting idle, particularly if the devices have been stationary.

5.5.1 No Communication Message

If the Scan Module is paired to the diagnostic tool and tries to communicate with the vehicle and the Scan Module is not connected to the vehicle, a “Connect Data Cable” or “no communication” message displays.

A signal lost due to moving out of range automatically restores itself when the diagnostic tool is brought closer to the Scan Module. The Scanner sounds a tone when the signal is lost.

The following conditions cause a “no communication” message to display:

- The Scanner is unable to establish a communication link with the vehicle.
- You selected a system for testing that the vehicle is not equipped with (such as ABS).
- There is a loose connection.
- There is a blown vehicle fuse.
- There is a wiring fault on the vehicle, or in the data cable or adapter.
- There is a circuit fault in the data cable, Personality Key, or adapter.
- Incorrect vehicle identification was entered.

Refer to the Vehicle Communication Software manuals for manufacturer-specific troubleshooting information.





5.5.2 Signal Loss / Out of Range Alarm

A signal lost due to moving the diagnostic tool out of range of the Scan Module will automatically restore itself when the diagnostic tool is brought closer to the Scan Module. The Scan Module will sound an audible tone when the signal is lost.

5.5.3 Checking Hardware Status

Verifying the Hardware Status is always the first step in troubleshooting a wireless connection issue.

The Hardware Status indicators in the lower-right corner of the Home screen provide a quick reference to wireless operations. The background color of the status indicator icon represents the condition of the wireless connectivity to that device. Icon status is shown in the table below:

Hardware Icon	Background Color	Condition	Action
	Red	Not Paired	Pair the Scan Module to the diagnostic tool. See Pairing The Scan Module on page 55 for instructions.
	Grey	Paired, but Not Communicating	You may have moved out of range. Move the diagnostic tool closer to the Scan Module to reestablish communications. If connectivity is not restored, perform the Recovery Procedure on page 61.
	Blue	Paired and Communicating	Hardware status is good and Bluetooth should be functional. Verify that the green Bluetooth LED on the front of the Scan Module is flashing. If there is no connectivity, perform the Recovery Procedure on page 61.
	Green	USB Cable Connected	Indicates the USB cable is connected.
	Gray	USB Cable Not Connected	Indicates the USB cable is not connected or connected but not allowing communication

The three light emitting diodes (LEDs) on the faceplate of the Scan Module let you know at a glance whether or not there is an active connection between the two modules. The two green LEDs (Vehicle Power and Bluetooth) both flash on and off when the Scan Module and diagnostic tool are actively communicating through a wireless connection. The red Communication LED flashes on and off when the Scan Module is performing an internal self test, and is illuminated continuously if a failure is detected ([Figure 5-6](#)).

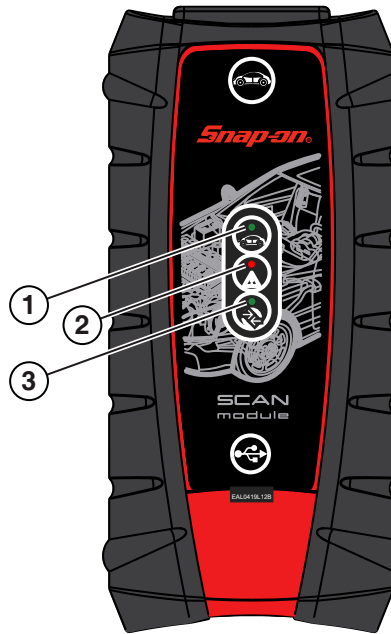

- 1— Vehicle Power—green LED, flashes during wireless communications**
- 2— Communication—red LED, illuminates if there is a communications failure**
- 3— Bluetooth—green LED, flashes during wireless communications**

Figure 5-6 Scan Module LEDs

Each LED can be in one of three states; off, lit solid, or flashing. Interpret as follows:

- Vehicle Power
 - Off, vehicle power is not being supplied to the Scan Module through the data cable
 - On Solid, the Scan Module is being powered by the vehicle, but not communicating with the Diagnostic Tool.
 - Flashing, the Scan Module is being powered by the vehicle and is communicating with the Diagnostic Tool.
- Communication
 - Off, normal state, no errors detected.
 - On Solid, communications error detected.
 - Flashing, internal self-test in process, will go out once the test completes.
- Bluetooth
 - Off, there is no connection between the Scan Module and Diagnostic Tool.
 - On Solid, the Scan Module and Diagnostic Tool are communicating through a solid (USB cable) connection.
 - Flashing, the Scan Module and Diagnostic Tool are communicating through a wireless connection.

5.5.4 Recovery Procedure

This is a quick and easy method that reestablishes connectivity between the diagnostic tool and the Scan Module in most instances. If bluetooth connectivity remains unavailable following recovery, use one of the alternate procedures to restart the system.

**NOTE:**

This product is intended to be used by professional technicians in a garage environment. Electrostatic discharges may happen occasionally and cause a loss of communication. To restore communication disconnect and reconnect the communication cables and follow screen prompts.

**To recover wireless connectivity:**

1. Disconnect the Scan Module from the vehicle.
2. Navigate to the Home Screen on the diagnostic tool.
3. Select **Exit** to close the ShopStream Diagnostic Suite.
4. Connect the Scan Module to the vehicle.
5. Select the **ShopStream Diagnostic Suite** icon on the desktop.



Figure 5-7 Sample ShopStream Diagnostic Suite desktop icon

**NOTE:**

The ShopStream Diagnostic Suite can also be started from the Windows Start menu.

Alternate Recovery Procedures

Use these methods as an option to the Recovery Procedure, or when recovery fails to restore the wireless connection.

USB Procedure

This method establishes a “hard-wired” USB cable connection between the modules.

**To create a USB connection:**

1. Carefully slip the ends of the handgrip off of the sides of the Scan Module housing.
2. Lift open the hinged cover on the base of the Scan Module.

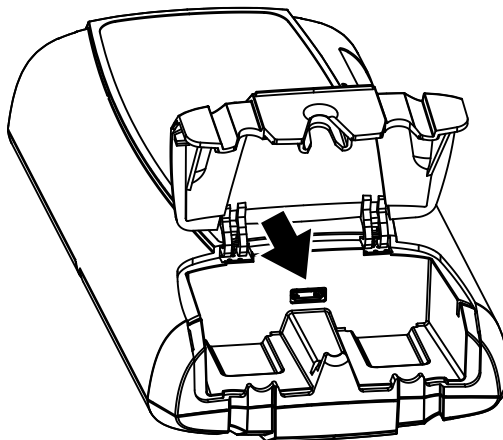

Figure 5-8 Scan Module USB jack, handgrip removed

3. Plug the small end of the USB cable into the USB jack on the Scan Module.
4. Plug the large end of the USB cable into a USB jack on the diagnostic tool.
Scanner functionality should be restored immediately once the USB connection is complete. If not, suspect a hardware failure. The diagnostic tool and Scan Module are both fully functional, so you can complete your testing with the USB connection intact.

ShopStream Diagnostic Suite Restart Procedure

This method, which closes and restarts the ShopStream Diagnostic Suite software, takes about two minutes to complete.



To restart the ShopStream Diagnostic Suite:

1. Navigate to the Home Screen on the diagnostic tool.
2. Select **Exit** to close the ShopStream Diagnostic Suite.
3. Wait for the Scan Module Communication LED to stop flashing.
4. Select the ShopStream Diagnostic Suite icon on the desktop.
The ShopStream Diagnostic Suite should open with connectivity restored.

Windows Reboot Procedure

This method, which completely shuts down the diagnostic tool, takes several minutes to complete.



To reboot the diagnostic tool:

1. Disconnect the Scan Module from the vehicle.
2. Navigate to the Home Screen on the diagnostic tool.
3. Select **Exit** to close the ShopStream Diagnostic Suite.
4. Select **Start** in the lower-left corner of the screen to open the menu.
5. Select **Turn Off Computer** from the menu.
6. Select **Turn Off** when the Confirmation window opens.
7. Wait for the tool to completely turn off, then press the **Power** button to restart the diagnostic tool.
8. Connect the Scan Module to the vehicle once the ShopStream Diagnostic Suite opens.

5.6 Updating Scan Module Firmware

The internal programming (firmware) of the Scan Module, may require periodic updates. These firmware updates (when available) are delivered with diagnostic software updates/upgrades. Firmware updates increase the Scan Module's diagnostic capabilities, typically by adding support for new tests, vehicles and enhanced applications to the vehicle databases.



Scan Module Firmware Update Process:

Upon starting the Scanner function, initially after a software update or upgrade has been installed, a message may be displayed to inform you an update is available ([Figure 5-9](#)).

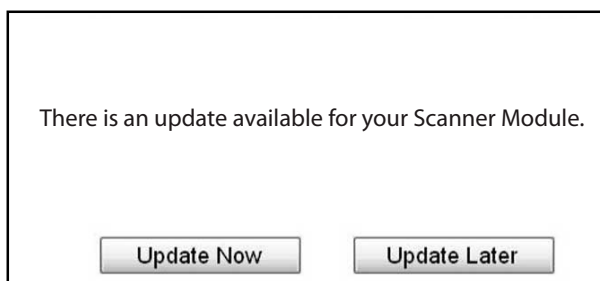

Figure 5-9 Scan Module update available message

IMPORTANT:

To supply power to the Scan Module, the data cable must be connected to the vehicle during the update process, with the vehicle ignition switch in the OFF position. To avoid damaging the Scan Module, never turn the ignition switch ON during the update process.

IMPORTANT:

To avoid damaging the diagnostic tool or scan module, it is highly recommended to connect the AC/DC power supply to the diagnostic tool before starting the firmware update process. Damage can occur to the scan module if the diagnostic tool power is turned off or the power supply is disconnected during the firmware update process.

1. Select the desired update option:
 - **Update Now** begins the process immediately.
 - **Update Later** defers the operation, closes the message, and starts the Scanner function. If you choose not to perform the update, it will not affect diagnostic tool operation, however you will not benefit from the additional features available in the update.
-



NOTE:

Selecting **Details** in the upper-right corner opens a list of what is included in the update.

Once the update process has been started, the update is performed wirelessly, and the installation progress is tracked on the screen ([Figure 5-10](#)).

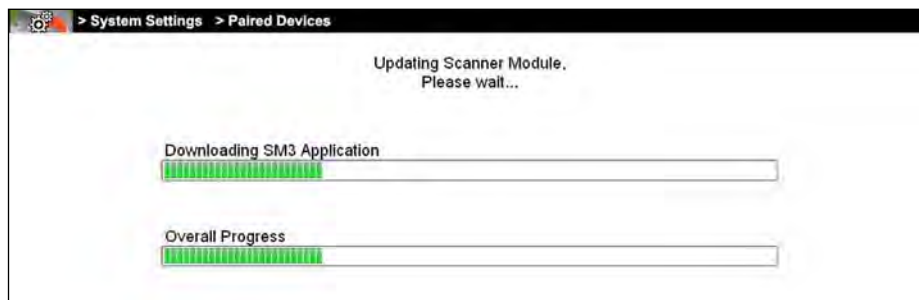

Figure 5-10 Sample update in progress screen

A “successfully updated” message displays once the installation process is complete (Figure 5-11).



Figure 5-11 Sample firmware update complete message

2. Select **OK** to close the message and return to Scanner operations.
The updated Scan Module, is ready to use.



Alternate Scan Module Firmware Update Process (USB cable):

If necessary, this alternate firmware update procedure may be used to update the Scan Module firmware.

IMPORTANT:

The diagnostic tool must be connected and powered by the AC/DC power supply during the Scan Module firmware update process. Damage can occur to the Scan Module if the diagnostic tool power is turned off or the power supply is disconnected during the firmware update process.

1. Connect the AC/DC power supply to the diagnostic tool.
2. Turn on the diagnostic tool.
3. Connect the Scan Module to the diagnostic tool as follows:

IMPORTANT:

The Scan Module data cable must be disconnected from the vehicle during the update process.

- a. From the bottom of the Scan Module, gently lift up and out on the sides of the handgrip to free it from housing (Figure 5-12).
- b. Open the hinged cover on the base of the Scan Module to expose the USB jack.
- c. Plug the small end of the USB cable into the USB jack on the Scan Module.
- d. Plug the large end of the USB cable into one of the USB jacks on the side of the diagnostic tool.

**NOTE:**

When connected, the scan module USB connection status icon background color will change from gray to green.

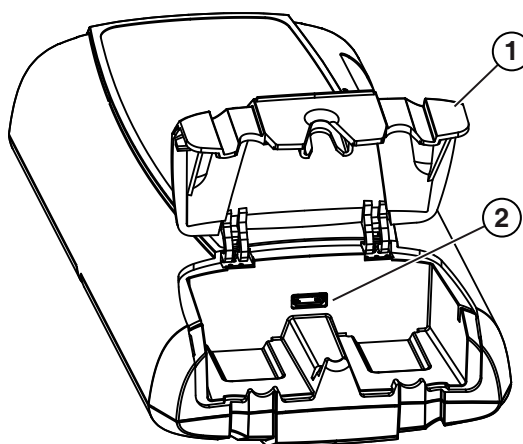

- 1— Hinged cover
2— USB jack

Figure 5-12 Scan Module USB jack

4. Select **Scanner** from the diagnostic tool Home screen.
5. Select **OK** when the update available message displays.
The update begins and installation progress is tracked on the screen (Figure 5-13).

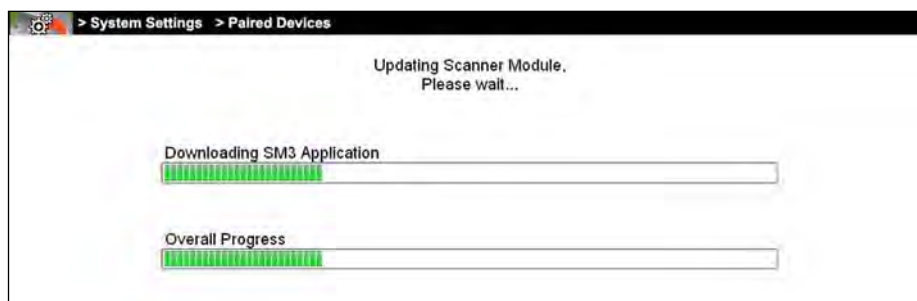

Figure 5-13 Sample update in progress screen

A “successfully updated” message displays once the installation process is complete (Figure 5-14).

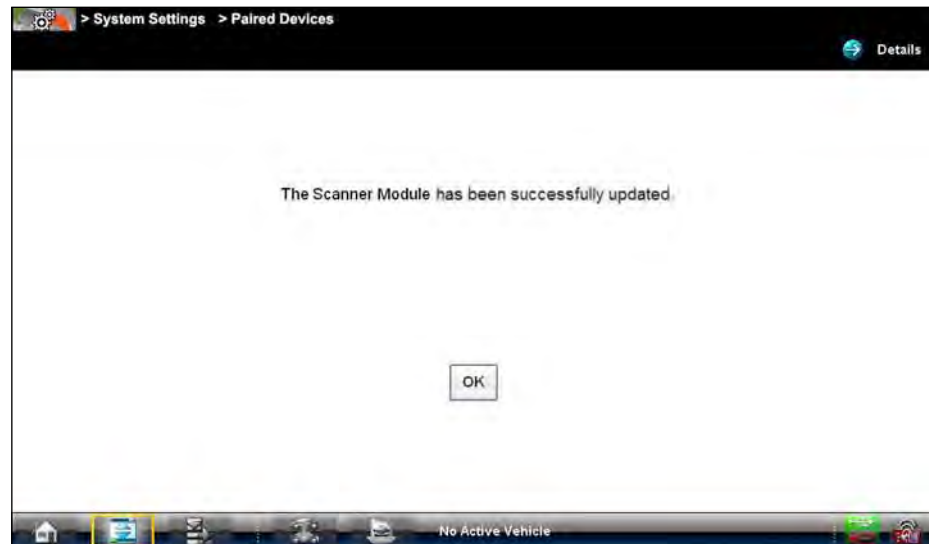

Figure 5-14 Firmware update complete message

6. Select **OK** to close the message and return to the Scanner function. The updated Scan Module, is ready to use.

This Home screen option allows you to access Generic OBD-II/EOBD Scanner tests without completing a vehicle identification. OBD Direct presents a quick way to check for diagnostic trouble codes (DTCs), isolate the cause of an illuminated malfunction indicator lamp (MIL), check monitor status prior to emissions certification testing, verify repairs, and perform a number of other services that are emissions-related. This mode is also used for testing OBD-II/EOBD compliant vehicles that are not included in the Scanner databases.

OBD Direct is a Scanner function, and the Scan Module must be connected to the test vehicle and communicating with the diagnostic tool. This function only provides generic OBD-II/EOBD information. To access enhanced OBD-II/EOBD functions, select Scanner from the Home screen.

Options for the Menu icon on the Toolbar at the base of the screen are the same as those available for the Scanner module.

Selecting OBD Direct on the Home screen opens a menu with two options ([Figure 6-1](#)):

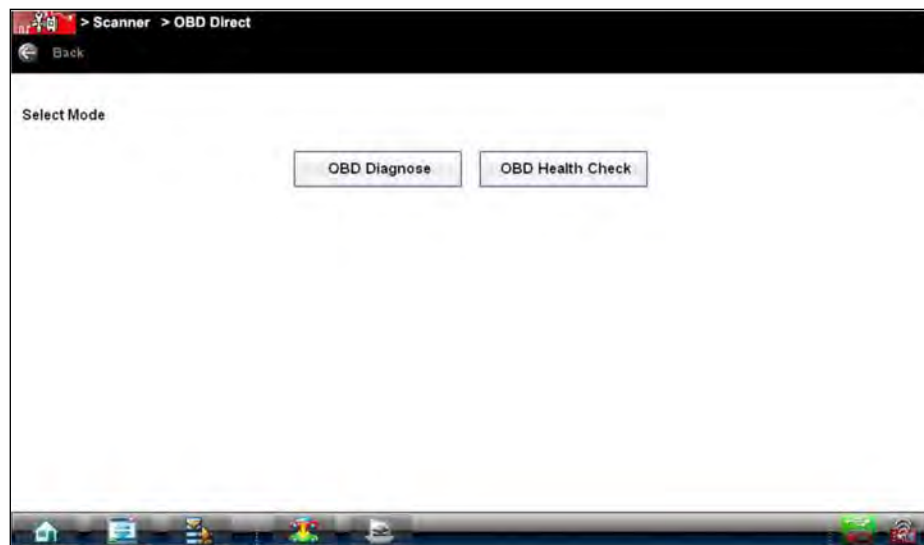

Figure 6-1 Sample OBD Direct main menu

6.1 OBDDirect Health Check

The OBDDirect Health Check offers a way to quickly check for and clear generic diagnostic trouble codes (DTCs) and to check readiness monitors. Selecting OBDDirect Health Check opens a submenu of options (Figure 6-2).

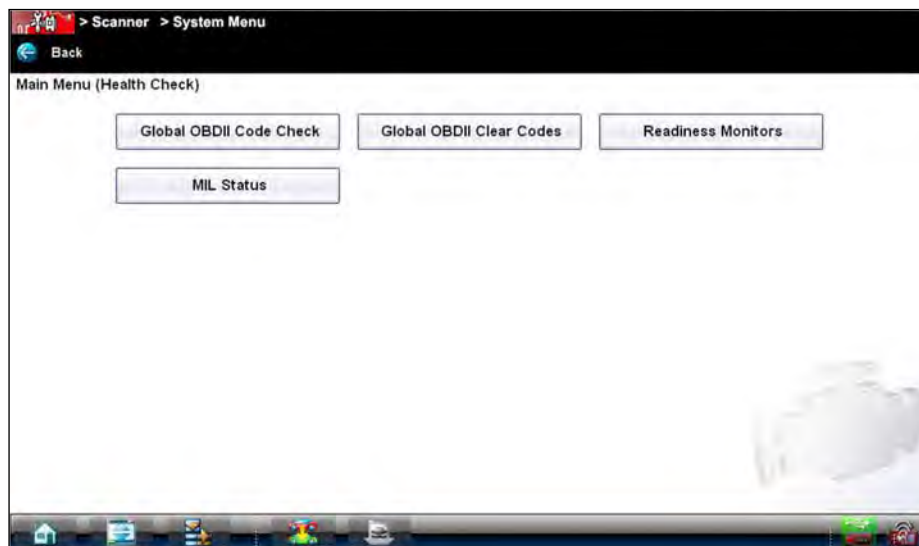

Figure 6-2 Sample OBDDirect Health Check menu

6.1.1 Global OBD II Code Check

This option displays any stored emission related generic DTCs reported by the ECM. Selecting opens a submenu with two choices:

- Codes
- Pending Codes

Codes

Codes displays a list of current emission related DTCs. OBD-II/EOBD Codes have a priority according to their emission severity, with higher priority codes overwriting lower priority codes. The priority of the code determines the illumination of the MIL and the code erase procedure. Manufacturers rank codes differently, so expect to see differences between makes.

Pending Codes

The purpose of this service is to enable the scan tool to obtain “pending” or maturing diagnostic trouble codes. These are codes whose setting conditions were met during the last drive cycle, but need to be met on two or more consecutive drive cycles before the DTC actually sets.

The intended use of this service is to assist the service technician after a vehicle repair and after clearing diagnostic information, by reporting test results after a single driving cycle.

- If a test failed during the driving cycle, the DTC associated with that test is reported. If the pending fault does not occur again within 40 to 80 warm-up cycles, the fault is automatically cleared from memory.
- Test results reported by this service do not necessarily indicate a faulty component or system. If test results indicate another failure after additional driving, then a DTC is set to indicate a faulty component or system, and the MIL is illuminated.

6.1.2 Global OBD II Clear Codes

This option is used to clear all emission related diagnostic data such as, DTC records, freeze frame data, and test results, from ECM memory. Although OBDDirect only displays generic OBD-II data, clearing codes erases all of the stored data including any enhanced codes.

A confirmation screen displays when the clear codes option is selected to prevent accidental loss of data. Select **Yes** on the confirmation screen to continue.

6.1.3 Readiness Monitors

Use this menu option to check the readiness of the monitoring system. An OBD-II/EOBD system checks the status of emission-related subsystems by running continuous or periodic tests. Test results are shown in the data viewer (Figure 6-3).

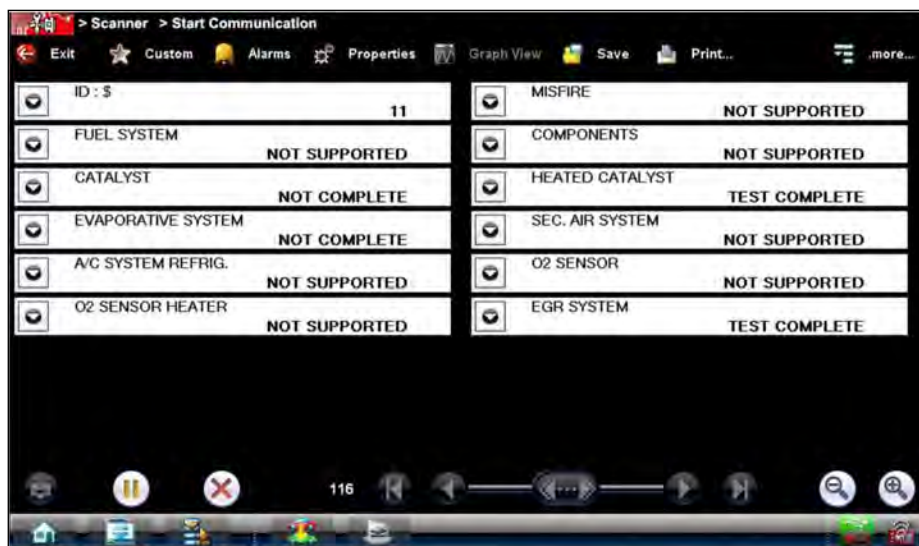

Figure 6-3 Sample readiness monitor test report

Gesture sweep to view the entire list of Readiness Monitors to ensure that all tests are complete. It is possible to print the readiness test status or save it as part of a Vehicle history.

6.1.4 MIL Status

This item is used to check the current condition of the malfunction indicator lamp (MIL). Additional information, such as which ECM commanded the MIL on and the distance driven while the MIL is on (if supported), can also be displayed. It is also possible to print the MIL Status.

6.2 OBD Diagnose

Selecting OBD Diagnose opens a menu with the following options:

- Start Communication—begins the test session
- Connector Information—provides data link connector (DLC) location details for most models
- Manual Protocol Selection—allows you to select which protocol to use

6.2.1 Start Communication

Use the following procedure to conduct an OBD Direct test session:



To perform an OBD Direct Test:

1. Select **Start Communications** from the OBD Direct menu.

A generic connection message displays ([Figure 6-4](#)), connect the Scan Module to the test vehicle as instructed.

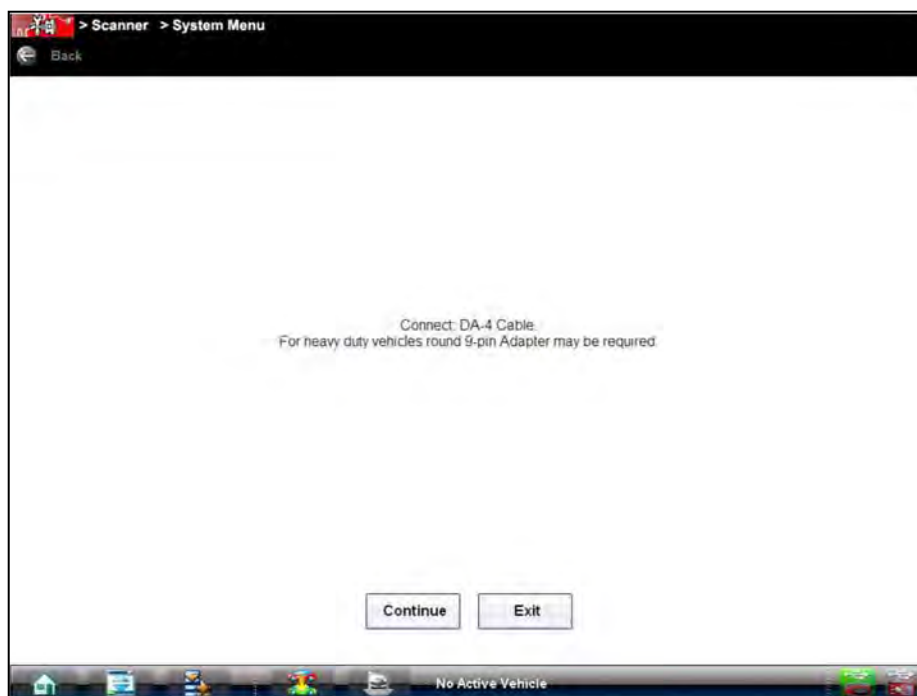

Figure 6-4 Sample generic connection message

2. Select **Continue**.

A communications message that shows how many ECMs were detected, which ECM is communicating, and which communication protocol is being used displays (Figure 6-5).

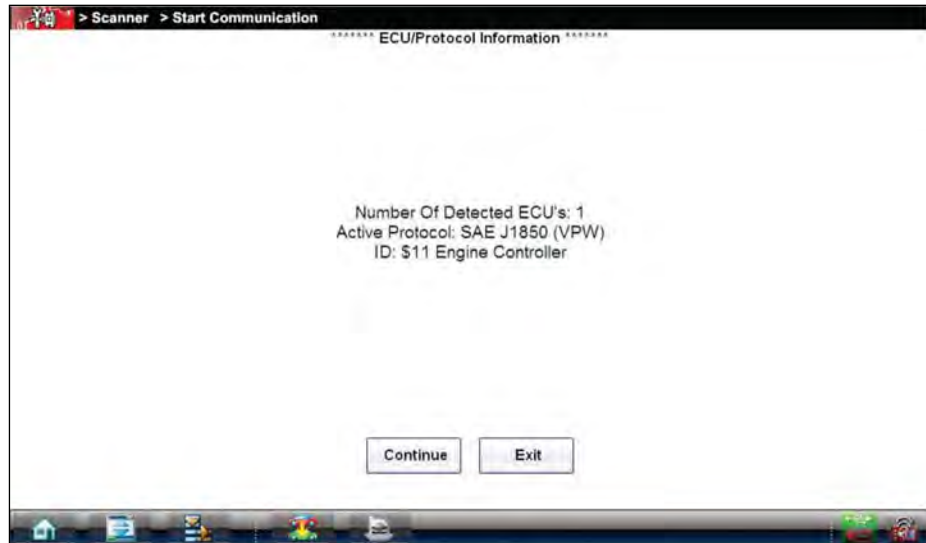

Figure 6-5 Sample communication message

3. Select **Continue** and a menu of available tests displays (Figure 6-6).

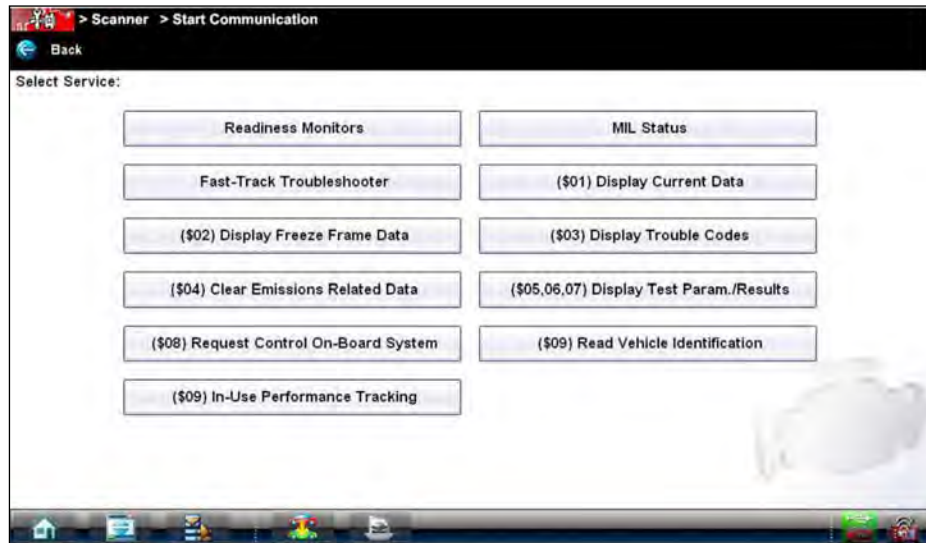

Figure 6-6 Sample Start Communication menu

4. Select a test to continue.

Readiness Monitors

Use this menu item to check the status of the monitored system. If a monitored system is not supported, it is not displayed. Scroll, if needed, to view the entire list of monitors. Selecting Readiness Monitors opens a submenu with two choices:

- **Monitors Complete Since DTC Cleared**—displays the results of all monitor tests that have run since the last time the electronic control module (ECM) memory was cleared.
- **Monitors Complete This Cycle**—displays only the results of monitor tests that ran during the current drive cycle, they reset when the ignition is switched off.

MIL Status

This item is used to check the current condition of the malfunction indicator lamp (MIL). Additional information, such as which ECM commanded the MIL on and also the distance traveled while the MIL is on (if supported), can also be displayed. It is also possible to print the MIL Status.

Fast-Track Troubleshooter

Fast-Track® Troubleshooter is a database of experience-based information of validated real-world repair strategies that have been compiled by top-notch technicians since 1988. The Troubleshooter system simplifies the diagnosis process, as it contains information on virtually all common diagnostic trouble code (DTC) problems and driveability symptoms for most vehicles covered by the vehicle communication software.

(\$01) Display Current Data

Use this item to display the current emission related data from the selected electronic control module (ECM) of the vehicle. Displayed data includes analog inputs and outputs, digital inputs and outputs, and system status information broadcast on the vehicle data stream. OBD Direct data displays similar to Scanner data, refer to [Data Display](#) on page 44 for details.

(\$02) Display Freeze Frame Data

This item is used to display freeze frame data for any stored emission related diagnostic trouble codes (DTC). In most cases the stored frame is the last DTC that occurred. Certain DTCs, those that have a greater impact on vehicle emission, have a higher priority. In these cases, the highest priority DTC is the one for which the freeze frame records are retained.

Freeze frame data includes a “snapshot” of critical parameter values at the time the DTC set.

(\$03) Display Trouble Codes

This option displays any stored emission related DTCs reported by the various ECMs. The OBD Direct code report is similar to a Scanner module code report, and includes the **Fix It!** icon with hyperlinks to Information details. See [Display Codes](#) on page 42 for additional information.

(\$04) Clear Emissions Related Data

This item is used to clear all emission related diagnostic data such as, DTCs, freeze frame data, and test results from the memory of the selected ECM.

(\$05, 06, 07) Display Test param./Results

This option opens a submenu of test parameters and test results from various sensors, monitor test results, and a record of DTCs detected during the last drive cycle. The menu includes:

- Oxygen Sensor Monitoring (\$05)
- On-Board Monitored Systems (\$06)
- DTCs Detected During Last Drive (\$07)

(\$08) Request Control of On-board System

This service enables bidirectional control of the ECM so that the Scanner is able to transmit control commands to operate the vehicle system. This function is useful in determining how well the ECM responds to a command.

Available options vary by make, model, and year of the test vehicle. Select a test and follow the on-screen instructions.

(\$09) Read Vehicle Identification

This selection displays the vehicle identification number (VIN), the calibration identification, and the calibration verification number (CVN) of the test vehicle.

(\$09) In-use Performance Tracking

This selection displays the "In-use Performance Tracking" of monitored data. It is basically a record of the number of times each of the monitor tests have been completed.

(\$0A) Emission Related DTC with Permanent Status

This service displays a record of any "permanent" codes on late-model vehicles if the vehicle supports Service \$0A. A permanent status DTC is one that was severe enough to illuminate the MIL at some point, but the MIL may not be on at the present time.

Whether the MIL was switched off by clearing codes or because the setting conditions did not repeat after a specified number of drive cycles, a record of the DTC is retained by the ECM. Permanent status codes automatically clear after repairs have been made and the related system monitor runs successfully.

6.2.2 Connector Information

This option opens a database of vehicle diagnostic connector locations that includes most makes and models.



To locate a vehicle diagnostic connector:

1. Select **Connector Information** from the System menu.
2. Select a manufacturer from the list presented.
3. Select a model from the list presented.
Instructions for which, if any, cable adapter or pin to use displays.
4. Select **Continue**.
Information on where to locate the vehicle diagnostic connector displays.
5. Select **Continue** to return to the System menu.

6.2.3 Manual Protocol Selection

A communication protocol is a standardized way of data communication between an ECM and a scan tool. Global OBD may use several different communication protocols. The scan tool automatically connects to an available protocol, which displays on the connection message (Figure 6-5). Some vehicles communicate on more than one protocol. Use the Manual Protocol Selection option to switch to a different protocol.

Select **Manual Protocol Selection** and message displays advising you to make sure you know the correct protocol for the test vehicle. An incorrect selection may activate warning lamps and set CAN related faults on the vehicle. Select **OK** and a menu of options displays (Figure 6-7).

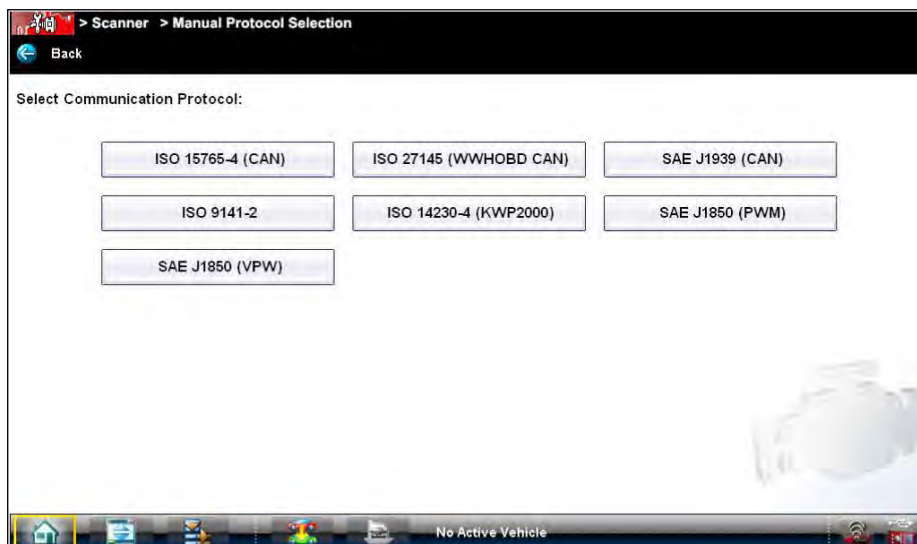

Figure 6-7 Sample communication protocol menu

Guided Component Test Operations

The Guided Component Test software is a component-testing powerhouse, providing you with a robust diagnostic database for use with scopes and meters. It is like having access to a complete library of shop manuals for testing engine-management components, transmission sensors and components, and ABS systems.

Guided Component Test helps you with everything from selecting the appropriate test for a specific component to showing the hook-up location and correct pin configuration. This software thoroughly guides and instructs you on proper testing procedures and offers tips from the internal troubleshooter database. The Guided Component Test procedures, tips, and meter settings reduce your overall set-up and diagnostic testing time. Vehicle-specific Guided Component Tests are provided for engine, transmission, ABS, charging, transfer case and suspension systems.

WARNING



Risk of electrical shock.

- **Read the *Important Safety Instructions* document provided separately for messages on the safe use of this product.**
- **This product is intended for Measurement Category I (for example, automotive 12V systems), do not use this product for Measurement Categories II, III, and IV.**
- **Measurement Category I is for performing measurements on circuits not directly connected to MAINS or MAINS circuits (an example of a MAINS circuit is 120V AC or 240V AC household or industrial electricity), do not connect this product to MAINS or MAINS circuits.**
- **Do not apply the Black Ground Lead to test points other than ground/system return/ vehicle chassis.**

Electrical shock can cause personal injury, equipment damage, or circuit damage.

IMPORTANT:

Maximum rated transient over voltage impulse is 500 volts, do not exceed the rated transient over voltage.

7.1 Vehicle Identification

The Guided Component Test information presented is specific to the vehicle being tested. Therefore, certain attributes of the test vehicle must be entered into the diagnostic tool so that the correct data can be retrieved. Vehicle identification information is carried over if you enter the Guided Component Test module either from the Scan Module or from one of the records stored in the Vehicle History module. However, you may need to enter additional attributes in some instances.

The vehicle identification sequence is menu driven, you simply follow the screen prompts and make a series of choices. Each selection you make advances you to the next screen.

7.1.1 Menu Options, Guided Component Test

Selecting the Toolbar Menu icon at the base of the screen offers the following options:

- [Safety Information](#)—opens the *Important Safety Instructions* document. See [Safety Information](#) on page iv for additional information.
- [File](#)—allows you to print, save and set page settings of the data being viewed.
- [Top Level Menus](#)—allows you to access supplemental information and training programs.
- [Help](#)—allows you to view supporting documentation. See [Help Operations](#) on page 144 for additional information.

File

Selecting **File** opens a menu of print options:

- **Print Article**—selecting has one of two results:
 - If a printer is connected, the file is sent to the printer.
 - If a printer is not connected, the article is saved as a (.xps) file, which can be retrieved, moved, or copied and printed at a later time.
- **Print Preview**—opens a representation of what the printed file will look like.
- **Page Setup**—allows you to adjust margins and paper orientation.

Top Level Menus

Selecting **Top Level Menus** opens a list of the following options:

- [Features Benefits](#)
- [How To](#)
- [Power User Tests](#)
- [Snap-on Automotive Theory](#)

Features Benefits

Selecting **Features Benefits** opens a menu page that includes:

- **5-Minute Walk Thru With Demo Board**—explains how to use the optional demonstration board to generate sample signals.
- **Features & Benefits**—provides descriptions and a brief overview of meter functions.
- **Accessories**—opens a menu of optional equipment available.
- **Product Description**—provides descriptions and a brief overview of meter operations.

The demonstration board not only helps you learn how to use the Guided Component Test software, it allows you to hone your skills and diagnostic technique without an actual test vehicle.

Power User Tests

The **Power User Tests** option gives you quick access to a pre-configured meter for conducting a number of control system tests. Tests are available with or without on-screen help. Help typically provides a description of the test along with expected results and a link to the pre-set meter.

How To

The **How To** option provides a list of available on-screen instructions for performing tasks. Scroll to view the entire list. Typical topics include:

- **10-Minute Electronic Classes**—provides brief instruction in basic electronics and circuit connections.
- **15-Minute Ignition Classes**—provides an introduction to basic ignition testing.
- **Illustrated Terms & Definitions**—provides definitions of terms, drawings and tips associated with Guided Component Testing.
- **No-start Basics**—provides a guideline for diagnosing a no-start condition.
- **O2 Sensor & Feedback System Analysis**—displays the Guided Component Test meter in the “live” graphing mode with O2S test tips to help you understand the fundamental concepts of O2S diagnostics.
- **Test Tips**—gives on-screen instructions for performing specific Guided Component Tests along with drawings and tips.
- **20-Minute Current Ramp Classes**—provides an introduction to current ramp testing.
- **Minute Current Ramp Classes**—provides an introduction to current ramp testing.
- **Theory And Operation**—provides basic theory and operation information for related components.

Snap-on Automotive Theory

Selecting the **Snap-on Automotive Theory** option provides you basic operation, theory and testing information on various systems such as:

- Air Conditioning
- Diesel Particulate Filters
- High-Intensity Discharge Headlights
- Supplemental Restraint Systems
- Diagnosing Battery Draws
- Electronic Parking Assistance Class
- LIN-Bus
- Tire Pressure Monitoring

7.1.2 Creating a Favorites List

Once a Guided Component Test database is loaded, a list of manufacturers displays. This list is often long and includes makes that are not frequently used. A toolbar at the top of the screen allows you to custom configure the manufacturer list to display only the makes you frequently service.



Figure 7-1 Sample manufacturer list



To configure a favorites list:

1. Select **Configure Favorites** on the toolbar.
A list of selectable manufacturers displays.

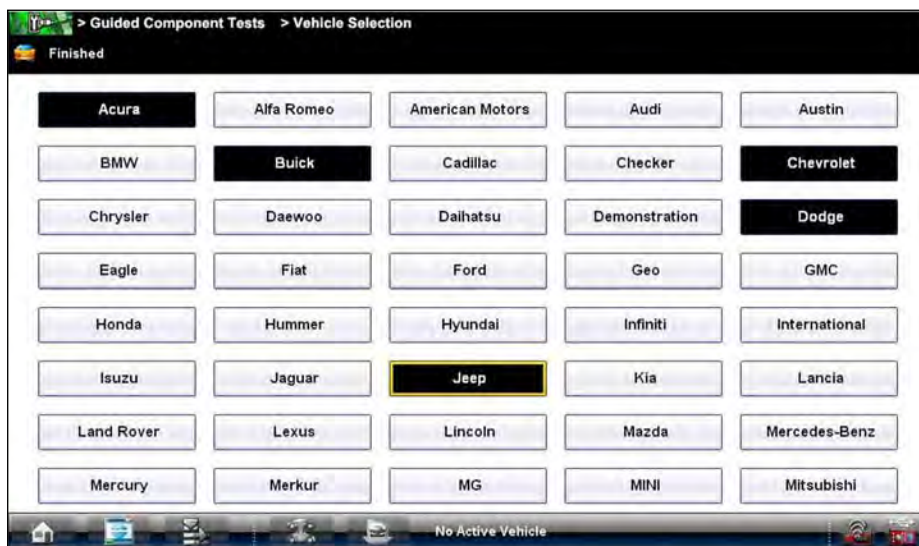

Figure 7-2 Sample Configure Favorites screen

2. Select each manufacturer you want to include, selected manufactures are highlighted.

**NOTE:**

Manufacturers appear on the favorites list in the order in which they are selected. Therefore, if you select the makes you work on most frequently first, they will appear at the top of the list.

3. Select **Finished** on the toolbar once your selections have been made.
The screen returns to the manufacturer list, but only the makes you selected display. Note the "Favorites" toolbar selection now reads "Full list".
4. Select **Full List** on the toolbar to view the complete list of manufacturers.
5. Select **Back** on the toolbar at any time to return to the previous screen.

Your favorites list is what will display whenever a Guided Component Test database is started in the future. The list can be modified at any time by selecting Configure Favorites from the toolbar.

7.1.3 Identifying a Test Vehicle

Exact procedures to identify the test vehicle may vary somewhat by vehicle and market. The following procedure, which identifies a 2008 Ford Focus for testing the fuel injection system, is typical of what to expect.

**To identify a vehicle for Guided Component Test:**

1. Select the **Guided Component Test** Function icon from the Home screen.
2. Select which database to load for the test vehicle if requested (optional).
After the database loads, a list of manufacturers displays.
3. Select **FORD** and a model year menu displays.
4. Select **2008** from the year menu and a list of available models displays.
5. Select **FOCUS** from the model list and a list of available engines displays.
6. Select **2.0L** from the engine list and a confirmation dialog box displays (Figure 7-3).

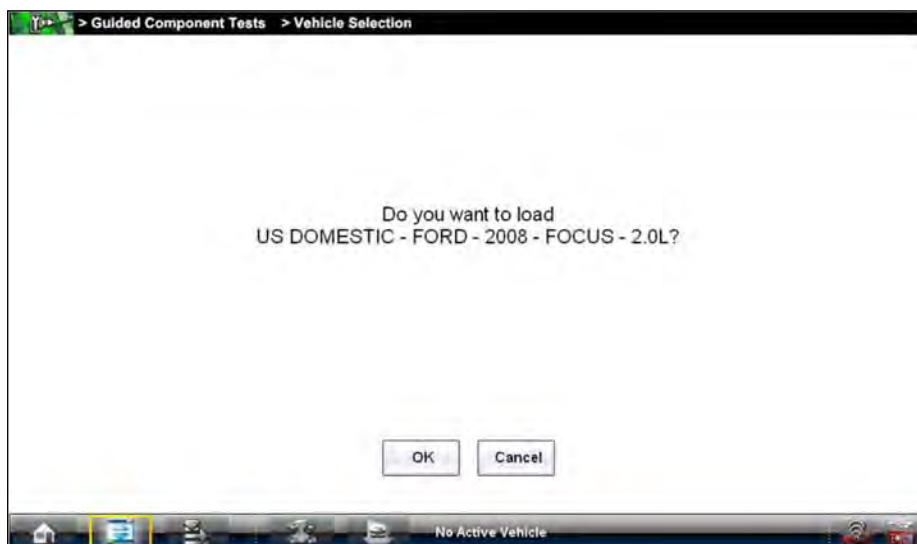

Figure 7-3 Sample confirmation dialog box

7. From the confirmation dialog box, select **OK** to continue, or **Cancel** to return to the engine list.

A list of tests available for the identified vehicle displays (Figure 7-4).



Figure 7-4 Sample available tests list

8. Select **FUEL INJECTION** and a fuel injection component test menu displays (Figure 7-5).

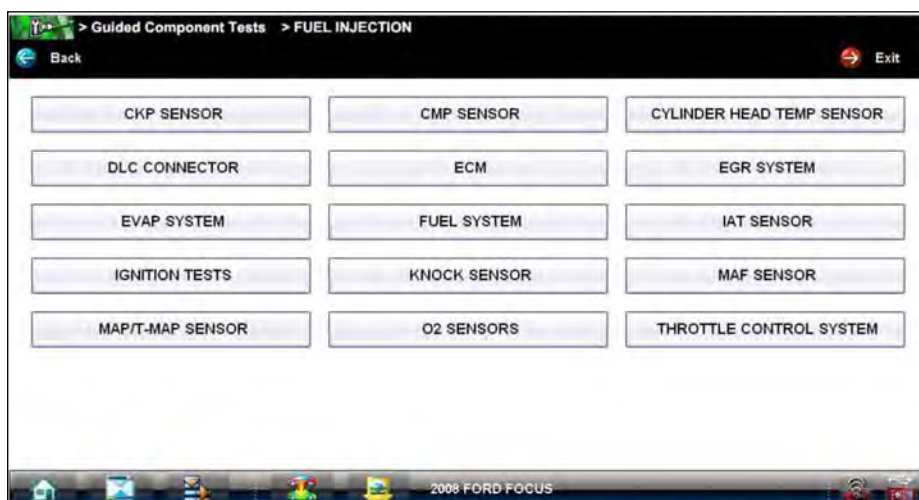

Figure 7-5 Sample available component tests list

9. Select a test to continue.

The identification sequence is now complete, refer to the Operations section that follows for details on how to navigate through the Guided Component Test information and perform tests.



NOTE:

If you return to the Home screen and select **Scanner** or **Vehicle History** the vehicle identification entered here is carried over. However, additional information may be needed for some modules.

7.2 Operations

The Guided Component Test software provides vehicle specific Guided Component Test procedures and information that aid in setting up scopes and meters. Once a test vehicle is identified, you can select a Guided Component Test from the list of available tests. For most selections two main choices are available on the component menu:

1. **COMPONENT INFORMATION**—provides information on the selected component and connector pin details that assists you in understanding the components prior to diagnosis.
2. **TESTS**—provides a pre-configured list of tests, guides you through performing the tests, and offers tips and resources to reduce setup and testing time.

7.2.1 Component Information

Component Information provides details on specific vehicle components to provide a better understanding of the components prior to diagnosis.

The Component Information screens contain information to assist you with testing. The screens are divided in sections to help quickly guide you to the correct information (Figure 7-6):

- **Operation**—provides a general description of normal component operation.
- **Connector**—displays the component connector and lists pin assignments.
- **Location**—identifies the component location and the best place for testing it.
- **Tech note**—provides Guided Component Test-related tips (for example, common failures or faults) as well as update or recall information.

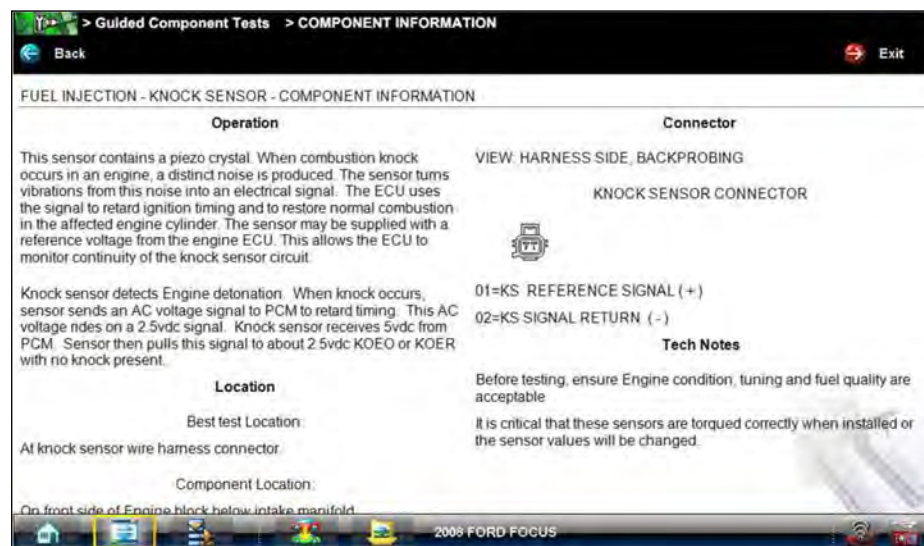

Figure 7-6 Sample Component Information screen



To view component information:

1. Select a component from the tests list.
2. Select **COMPONENT INFORMATION** from the component menu.

**NOTE:**

An additional selection, such as front or rear for an oxygen sensor (O2S), may be required before advancing to the component information screen.

The component information screen displays (Figure 7-6).

3. Always Gesture sweep to view any additional information below what is visible.
4. Select **Back** at any time to return to the previous screen.

7.2.2 Tests

The Tests section guides you through the process of performing tests on a specific component. It also provides specifications, tips on how and where to connect the test meter leads, and also automatically configures the multimeter or lab scope to perform the selected test.

Once a test vehicle is identified, you can select a component from the available tests list.

**To select a test:**

1. Select a component from the list.
2. Select **TEST** to open the list.

**NOTE:**

More than one selection is available in some instances. For example, select Ignition Tests and a menu offering Primary Tests and Secondary Tests displays.

The list shows all of the tests available for the selected component, choices vary by make, model, and year.

Selecting opens an additional submenu similar to the one shown in Figure 7-7 when more than one option is available.

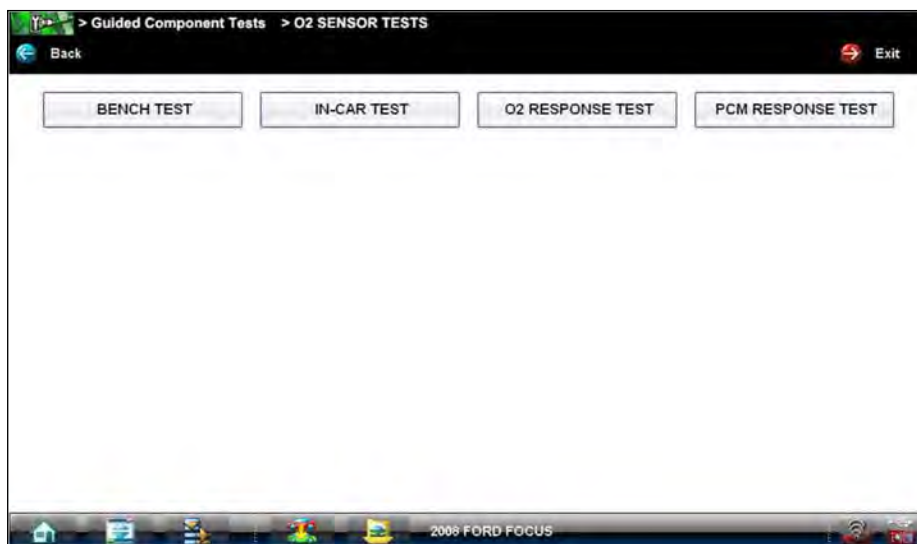

Figure 7-7 Sample O2S voltage test submenu

3. Select a test option and the test screen displays (Figure 7-8).

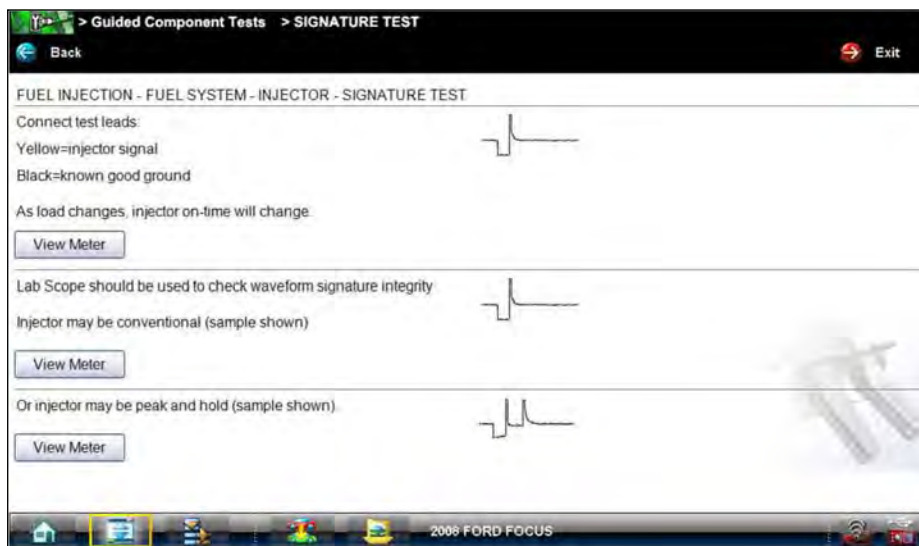

Figure 7-8 Sample Test screen

4. Gesture sweep to view any additional information.
5. Select **Back** at any time to return to the previous screen, or select **Exit** to return to the main component menu.

Hyperlinks

Guided component test screens contain hyperlinks that can either take you to another page containing additional information or open an additional window on top of the current screen. Hyperlinks display as icons. Common hyperlinks are:

- **View Meter**—opens a live meter set up to perform the test in the lower portion of the screen (Figure 7-9). Once the meter view is open, the Guided Component Test toolbar at the top of the screen is replaced by the Scope Multimeter toolbar, which allows you to make adjustments to the settings. See [Scope Multimeter Toolbar](#) on page 93 for details.
- **Show More Information**—advances to a new screen with more detailed information about a particular test, select **Back** to return to the test screen.

View Meter

A Meter icon, which is only available in the Guided Component Test view meter mode, appears on the upper toolbar (Figure 7-9).

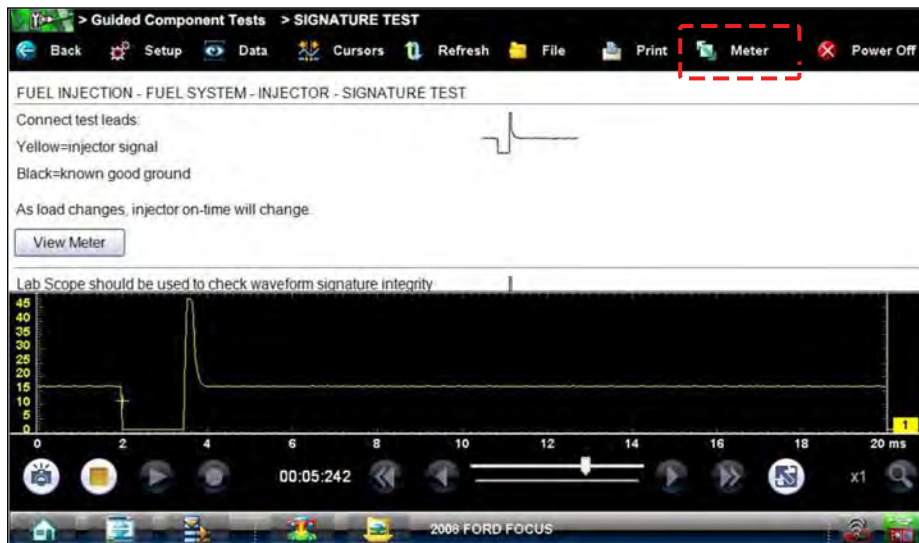

Figure 7-9 Sample view meter window

Three view meter options are available:

1. With View Meter active (Figure 7-9), select the **Meter** icon on the toolbar once and the meter expands to fill the entire screen.
2. Select the **Meter** icon a second time and the meter open as a separate window (Figure 7-10). This window can remain open if you switch to the Scan Module and can be accessed from the Windows toolbar at the bottom of the screen. You can also resize and reposition the meter window on the screen.

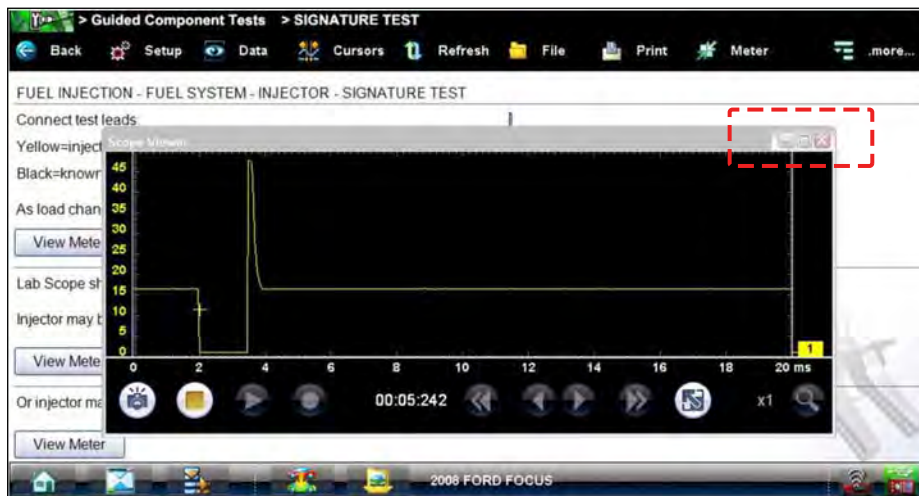

Figure 7-10 Sample meter view in a separate window

Selecting the **Close** icon (red box with an X) when viewing the meter in a separate window closes the meter and returns you to the Guided Component Test screen.

3. Select the **Meter** icon a third time to close the separate window and return to the standard meter view as shown in [Figure 7-9](#).

Select **Exit** from the toolbar to close meter view and return to the Guided Component Test screen.

Connecting to a Test Vehicle

Before performing a test, you must connect the meter test leads to the vehicle. Certain Guided Component Tests require the use of specific leads. Information on specific leads and other connecting information displays on the initial test screen. Follow the on-screen connection instructions in the test procedure to connect the test leads.

Performing a Test

Once you connect the test leads to the vehicle, you can proceed with testing.



To perform Guided Component Tests:

1. Follow the instructions displayed in the test procedure section.
2. Gesture sweep to view all of the instructions and follow the on-screen procedures.
3. Select the View Meter hyperlink to display test results.
4. Refer to the on-screen information to verify test results.

This Scope Multimeter module provides all the tools needed for performing electrical and electronic circuit tests and for monitoring signals and circuit activity. The Scope Multimeter works interactively with other modules. Selecting “View Meter” from a Guided Component Test or Scanner Test starts the Scope Multimeter module.

WARNING



Risk of electrical shock.

- Read the Safety Information provided for important warnings on the use of this product
- This product is intended for Measurement Category I (for example, automotive 12V systems), do not use this product for Measurement Categories II, III, and IV.
- Measurement Category I is for performing measurements on circuits not directly connected to MAINS or MAINS circuits (an example of a MAINS circuit is 120V AC or 240V AC household or industrial electricity), do not connect this product to MAINS or MAINS circuits.

Electrical shock can cause personal injury, equipment damage, or circuit damage.

IMPORTANT:

Maximum rated transient over voltage impulse is 500 volts, do not exceed the rated transient over voltage.

8.1 Getting Started

The Scope and Multimeter module enables the following functions:

- Lab Scope
- Ignition Scope
- Graphing Multimeter
- Digital Multimeter

8.1.1 Capabilities

The following tables detail the software and hardware capabilities.



NOTE:

200V to 400V scales are not to be used to measure signals greater than 50VAC (rms) or 75VDC.

IMPORTANT:

Do not use the Low Amp Probe to measure current on conductors at a potential greater than 46VAC peak or 70VDC.

Table 8-1 Scope

Function	Range	Accuracy/Comments
Signal Measurement	Ch. 1—yellow banana jack Ch. 2—green banana jack Ch. 3—blue banana jack Ch. 4—red banana jack	Each channel input is referenced to common ground input (GND—black banana jack)
Sample Rate	Single trace mode = 6 MSPS (Ch. 1 only) Dual trace mode = 3 MSPS (Ch. 1 & 2 only) Four trace mode = 1.5 MSPS (Ch. 1–4)	Continuous sampling, MSPS = mega samples per second
Bandwidth	DC–3 MHz	3 db point @ 3 MHz
Input Impedance	10 MOhm @ DC 4 kOhm @ 3 MHz	Channel 1–4
VDC (Full Scale)	100mV–400V	Do not measure greater than 75VDC
VAC (Full Scale)	100mV–400V	Do not measure greater than 50VAC (rms)

Table 8-2 Graphing Multimeter

Function	Range	Accuracy/Comments
Signal Measurement	Ch. 1—yellow banana jack Ch. 2—green banana jack Ch. 3—blue banana jack Ch. 4—red banana jack	Each channel input is referenced to common ground input (GND—black banana jack)
Sample Rate	1.5 MSPS	Continuous sampling, MSPS = mega samples per second
Bandwidth	DC–3 MHz	3 db point @ 3 MHz
Input Impedance	10 MOhm @ DC 4 kOhm @ 3 MHz	Channel 1–4
VDC (Full Scale)	75VDC	Do not measure greater than 75VDC
VAC (Full Scale)	50VAC	Do not measure greater than 50VAC (rms)
Low Amp Probe	20A scale (100mV/Amp) 40A scale (10mV/Amp)	Connect Low amp Probe (+) to Ch. 1 (yellow banana jack) and (–) to GND input (black banana jack). See NOTE below.

Table 8-3 Digital Multimeter

Function	Range	Accuracy/Comments
Signal Measurement	Ch. 1—yellow banana jack	Channel 1 input is referenced to common ground (GND—black banana jack)
VDC (Full Scale)	75VDC	Do not measure greater than 75VDC
VAC (Full Scale)	50VAC	Do not measure greater than 50VAC (rms)
Signal Measurement Input Impedance	10 MOhm	
Ohm Measurement Diode Test Continuity Test	Ch. 3—blue banana jack Ch. 4—red banana jack	Each channel input is referenced to common ground (GND—black banana jack)
Ohms	400 Ohm–4 MOhm	Fixed scales or Auto Ranging
Glitch capture	Approximately 50 uS	
Diode Test	2 V Scale	

8.1.2 Leads, Probes and Adapters

The Scope Multimeter uses standard safety banana plugs that are compatible with many accessories. The various leads, probes, clips, and adapters that are supplied with or available for the Diagnostic Tool explained in this section.

IMPORTANT:

When removing leads from their sockets, do not pull on the wire because it can damage the leads. Pull on the plug.

Channel 1 Lead

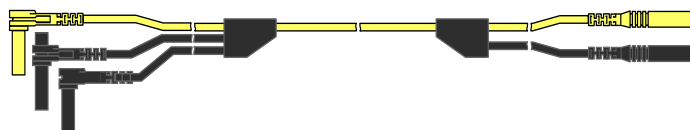

Figure 8-1 Yellow Channel 1 Lead

The shielded yellow lead is used for Channel 1 (Figure 8-1) and other channel connections that need additional grounding. The lead color matches the color of socket 1 on the diagnostic tool and the color of trace 1 on the test screens.

This yellow lead includes a black, right-angle, common ground plug and a black, stackable, right-angle, common ground plug. The non-stackable ground plug always connects to the ground (GND) jack on top of the diagnostic tool. The stackable ground plug is used for connecting additional leads, such as the Channel 2 Lead or the Secondary Coil Adapter Lead, that require grounding. The stackable lead does not need to be connected to the GND jack on the diagnostic tool, it grounds through the non-stackable lead.

Channel 2 Lead



Figure 8-2 Green Channel 2 lead

The shielded green lead (Figure 8-2) is used for Channel 2. The lead color matches the color of socket 2 on the diagnostic tool and the color of trace 2 on the test screens. This green lead includes a stackable, black, right-angle, ground plug.

Channel 3 Lead



Figure 8-3 Blue Channel 3 lead

The non-shielded blue lead (Figure 8-3) is used for either Channel 3 or Digital Meter minus (-). The lead color matches the color of socket 3 on the diagnostic tool, as well as the color of trace 3 on the test screen.

Channel 4 Lead



Figure 8-4 Red Channel 4 lead

The non-shielded red lead (Figure 8-4) is used for either Channel 4 or Digital Meter plus (+). The lead color matches the color of socket 4 on the diagnostic tool, as well as the color of trace 4 on the test screen.

Alligator Clips

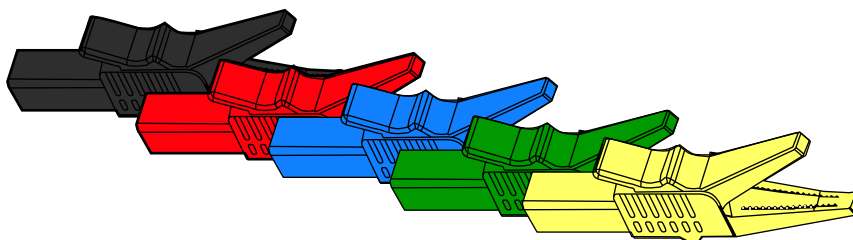

Figure 8-5 Alligator clip

Four insulated alligator clips are included and colored to match each test lead, a black clip for the common ground lead is also supplied (Figure 8-5). Each clip plugs into the straight end of a channel lead.

Test Probes

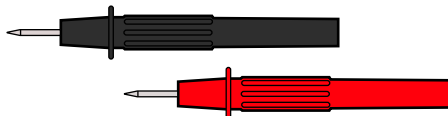

Figure 8-6 Test probe

Two test probes are included, one black and one red (Figure 8-6) and plug into the straight end of the test leads.

Secondary Coil Adapter Lead (optional)

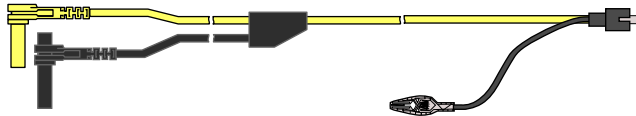

Figure 8-7 Secondary Coil Adapter lead

The optional Secondary Coil Adapter lead (Figure 8-7) connects to the clip-on secondary wire adapter, coil-in-cap adapter or coil-on-plug adapter to display secondary waveforms.

Secondary Ignition Clip-on Wire Adapter (optional)



Figure 8-8 Secondary Ignition Clip-on Wire Adapter

The optional Secondary Ignition Clip-on Wire Adapter (Figure 8-8) connects the Secondary Coil Adapter lead to the vehicle Secondary wire to display ignition patterns.

Inductive RPM Pickup Adapter (optional)



Figure 8-9 Inductive RPM Pickup adapter

The optional Inductive RPM Pickup adapter (Figure 8-9) connects to the scope auxiliary jack of the diagnostic tool with a DB9F plug. It can be used to trigger a waveform or display RPM. With the Ignition Scope, the RPM Pickup connects to cylinder number one to establish the firing order.

Low Amp Current Probe (optional)

The optional Low Amp Current Probe provides accurate and reliable non-intrusive testing of ignition coils, fuel injectors, fuel pumps, relays, electric motors, and parasitic draw. The optional Low Amp Current Probe measures current from 10 mA to 60 Amps.



Figure 8-10 Low Amp Current Probe

8.1.3 Menu Icon Options, Scope Multimeter

The Menu icon on the Toolbar at the base of the screen opens a menu with the following options:

- [Safety Information](#)—opens the *Important Safety Instructions* document.
- [File](#)—allows you to print or save the data or meter setup being viewed.
- [Setup](#)—allows you to adjust certain tool settings once a test has been selected.
- [Help](#)—allows you to view supporting documentation.

File

Use to print or save a copy of the data currently being viewed. Selecting opens a submenu:

- **Save Multimeter**—opens an additional submenu with these options:
 - **Save Configuration**—saves the current screen setup as a preset for quick access.
 - **Save Single Frame**—saves a recording of the current screen.
 - **Save All Frames**—saves a recording of the current screen plus all the data in the buffer.
- **Print**—opens a standard Windows Print dialog box for printing the current screen. A message will display asking if you wish to print only the scope or the entire screen display. Answering No will print the entire displayed screen.

Setup

This option allows you to adjust tool settings to your personal preferences. Selecting opens a menu of the following:

- [Unit Setup](#)—opens the Unit Setup dialog box to adjust trace and display settings
- [Snapshot](#)—opens the Snapshot dialog box for selecting how triggered data is saved.
- [Ignition](#)—opens the Ignition dialog box for setting up to display secondary ignition patterns.

Help

A variety of utilities and additional resources are available through the Help menu:

- User Manual
- Version Info
- Activation Status
- Scope About

Scope About

This option opens a dialog box that contains the software version and other specific details about the Scope module. A **Copy to Clipboard** icon allows you to copy and paste the information to a document or e-mail.

8.2 Navigation

The following section describes how to navigate the screen interface.

8.2.1 Screen Layout

The screens typically include the following sections ([Figure 8-11](#)):

- **Scope Multimeter Toolbar**—allows you to configure the tool for the type of test and to adjust the settings for each channel, or trace.
- **Main Body of the screen**—displays test results. Options on the toolbar let you select how tests display on the screen.
- **Trace Details**—displays trace settings, which can be adjusted or switched through the touch screen.
- **Record/Playback Control Toolbar**—allows you to record and navigate through paused data.



- 1— Scope Multimeter Toolbar
- 2— Main Body
- 3— Trace Details
- 4— Record/Playback Control Toolbar

Figure 8-11 Scope Multimeter screen layout

Scope Multimeter Toolbar

The Scope Multimeter toolbar is used to set up the tool for testing and to configure the settings for each trace. The table below gives brief descriptions of the control icons on the toolbar:

Table 8-4 Scope Multimeter toolbar icons (part 1 of 2)





Name	Icon	Description
Back		Returns to the previously viewed screen.
Setup		Opens a dialog box that allows you to select personal preferences for viewing and saving data.
Data		Switches the trace information displayed at the base of the screen between three available states.
Cursors		Opens a dialog box that allows you to switch cursors on and off, and to reposition them on the screen.
Refresh		Updates data on the viewing screen.

Table 8-4 Scope Multimeter toolbar icons (part 2 of 2)

Name	Icon	Description
File		Opens a dialog box that allows you to select options for saving data.
Print		Opens a dialog box that allows you to configure and print data.
Power Off		Switches the Scope Multimeter off. This retains the settings and reduces battery drain when switching to a different module. The Play and Record icons on the Playback toolbar switch the meter back on.

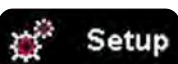
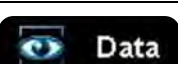
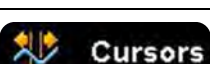
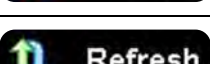
Main Body of the Screen

The main body of the screen varies depending on what display options have been selected. Up to four traces, along with digital readouts of current signal values, signal status and triggering conditions, can be displayed simultaneously on the main body of the screen. Adjustments to the display are made through the scope toolbar as explained above.

Each trace is displayed as voltage over time on a standard oscilloscope screen. Voltage level is recorded on the vertical, or “y”, axis and time is presented on the horizontal, or “x”, axis of the screen. Values are shown for each graduation on the scales.

When using pressure transducers, the pressure being sensed is converted into a voltage signal. However, the values are shown as pressure on the display screen rather than voltage.

Trace Details

The Trace Details section displayed at the base of the screen can be used to quickly adjust settings for capturing the trace. The Trace details are accessed using either the **Data** icon on the upper toolbar or the **Touch and Grow** icon (fingerprint) icon on the Playback toolbar. Both icons function the same and cycle the Trace Details selection through three states:

- **Displayed**—trace settings are displayed in this mode
- **Expanded**—trace settings are displayed in a larger format in this mode
- **Off**—trace settings are not displayed in this mode

Adjustments are made by selecting the item to be changed on the screen. A dash (–) indicates a function that is not selected, and an icon displays to indicate an active function ([Figure 8-12](#)).

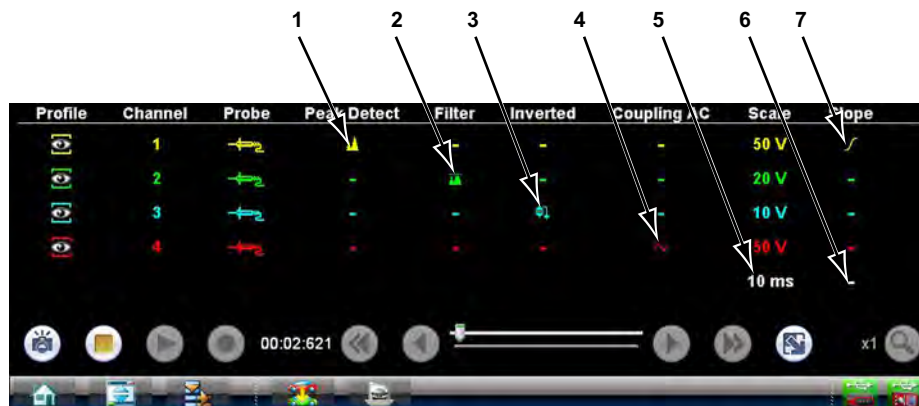

- 1— Peak Detect on
- 2— Filter on
- 3— Inverted trace
- 4— Coupling AC on
- 5— Sweep setting
- 6— Trigger setup
- 7— Trigger set on the rising slope

Figure 8-12 Sample data detail display

The following trace adjustments and settings are available:











- **Profile**—switches the trace for the selected channel on and off.
- **Channel**—opens a dialog box that allows you to configure the trace setup (see [Trace Controls](#) on page 100 for details).
- **Probe**—opens a dialog box that allows you to select the type of test probe being used.
- **Peak Detect**—maximizes the signal sampling rate in order to capture fast events, such as spikes, glitches and other anomalies, that may normally be undetected.
- **Filter**—smooths out the trace when the signal is disrupted by noise or other interference.
- **Inverted**—switches the polarity of the displayed signal.
- **Coupling AC**—subtracts the average value of the waveform by blocking the DC portion of an input signal in order to amplify the AC portion. This allows small variations in the trace to become visible.
- **Scale**—opens a dialog box that allows you to select the scale, which is the total value displayed on the vertical axis of the display. The value shown in white at the bottom of the list is the current sweep setting, selecting it open a dialog box that allows you to adjust the sweep (see [Sweep Controls](#) on page 101 for details).
- **Slope**—only active when a trigger is set, indicates whether the trigger is set to activate on the rising or falling slope of the trace. Selecting the slope icon switches the slope. The white dash at the bottom of the slope column is used to set the trigger, selecting it opens the trigger setup dialog box (see [Trigger Controls](#) on page 102 for details).

Record/Playback Control Toolbar

The record/playback control toolbar at the base of the screen is used for recording data and for reviewing paused data. Use the stylus or your finger tip to activate the icons. A position counter in the toolbar displays a numerical value of where the current screen is in relation to the entire recorded file.

Use the toolbar icons (Table 8-5) to navigate the data.

Table 8-5 Data buffer toolbar icons

Name	Icon	Description
Snapshot		Arms the software to take a snapshot of the sampled data
Step Back		Moves to the previous point in the recorded data
Back 1 Frame		Moves to the previous frame in the recorded buffer
Stop		Stops recording data
Record		Begins recording data
Play Recording		Plays the data recording in a continuous loop at actual speed
Forward 1 Frame		Moves to the next frame in the recorded buffer
Step Forward		Moves to the next point in the recorded buffer
Position Indicator		In record mode, indicates how much data is collected. In playback mode; shows the position of the buffered data currently displayed as minutes:seconds:milliseconds of elapsed time
Touch and Grow		Expands and collapses the Trace Detail area on the display screen to allow for easier finger tip control
Zoom		Increase or decrease the magnification of the graph

Use the slider in the middle of the toolbar to quickly move through paused data.

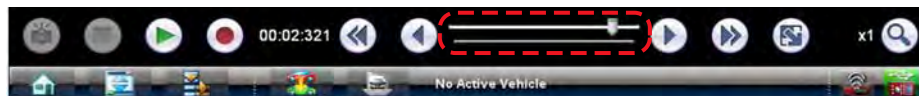

Figure 8-13 Sample data buffer slider

8.2.2 Making Selections

Most selections for setting up and operating the scope are made using the stylus and the scope toolbar. The cursor lines, the trace zero line, and the trigger point indicator (+) can be repositioned by selecting and dragging them in the main body of the screen.

There are two basic types of controls on the toolbar:

- Switches
- Dialog boxes

A Switch changes states when selected. Changes happen immediately as the selection is made.

A dialog box opens as a separate window on the screen and typically includes a number of choices. Changes happen immediately, however, the dialog box must be closed to return to the main window and continue. Make a selection to close the dialog box.

8.3 Operations

This section describes configuring the scope or meter and performing tests. Selecting “View Meter” from a Guided Component Test or Scanner screen saves time by automatically configuring the scope or meter.

8.3.1 Starting the Scope and Multimeter

Use the following procedure to set up the scope multimeter for performing tests.



To start the scope multimeter:

1. Select the **Scope Multimeter** icon on the Home screen.
The Scope Multimeter main menu, a list of setup options, displays;
 - Lab Scope
 - Ignition Scope
 - Graphing Meter
 - Digital Multimeter
 - Presets
2. Select the correct main menu option for the tests to be performed.
A submenu of scope or meter configuration displays, see below for additional information.
3. Select the correct configuration for the tests to be performed.
The Scope Multimeter displays configured for the selected test.

Lab Scope Options

The following options are available for testing:

- 4 Channel Lab Scope
- Volts DC
- Low Amps (20)
- Low Amps (40)
- Low Amps (60)
- Ignition Probe
- 100 PSI Vacuum
- 100 PSI Pressure
- 500 PSI Pressure
- 5000 PSI Pressure

Graphing Options

The following options are available for testing:

- 4 Channel Graphing
- Volts DC
- Volts DC Average
- Volts AC RMS
- Frequency
- Pulse Width
- Injector Pulse Width
- Duty Cycle
- Low Amps (20)
- Low Amps (40)
- Low Amps (60)
- MC Dwell (60)
- MC Dwell (90)
- 100 PSI Vacuum
- 100 PSI Pressure
- 500 PSI Pressure
- 5000 PSI Pressure

Ignition Scope Options

The following options are available for testing:

- Parade
- Cylinder
- Raster
- Superimposed
- Single Cylinder Ignition

Digital Multimeter Options

The following options are available for testing:

- Volts DC
- Volts DC Average
- Volts AC RMS
- Ohms
- Diode/Continuity
- Low Amps (20)
- Low Amps (40)
- Low Amps (60)

Presets

Presets are factory configured meter settings for common component tests. Selecting opens a list of available setups. Selecting from the list opens the scope multimeter configured to perform the selected test. In addition to the factory presets, you can create your own custom meter configurations and save them as presets.

8.3.2 Measurement Out of Range

A group of arrows display when a measurement is out of range for the scale selected:

- Arrows pointing UP—measurement over maximum range
- Arrows pointing DOWN—measurement under minimum range

Voltage measurements also display arrows in place of live values when the voltage exceeds the input rating of the meter.

WARNING



Risk of electrical shock.

- **Do not exceed voltage limits between inputs as indicated on the rating label.**
- **Use extreme caution when working with circuits that have greater than 40 volts AC or 24 volts DC.**

Electrical shock can cause personal injury, equipment damage, or circuit damage.

IMPORTANT:

If arrows are displayed in the live voltage values, discontinue circuit testing.

Correct an out-of-range condition by selecting a scale setting appropriate for the signal being sampled. See [“Trace Controls” on page 100](#) for more information.

8.3.3 Scope and Multimeter Setup

The following sections explain how to adjust the scope and multimeter for the specific type of signal being sampled. Most of these setup operations are available from the toolbar.

Trace Controls

The Traces controls are used to adjust individual characteristics of how the signal is sampled and displayed for each of the four traces.



To adjust trace controls:

1. Select **Setup** from the Scope Multimeter toolbar.
The Scope Multimeter Preferences dialog box opens.
2. Select **Traces** to open the submenu.
3. Select the tab for the trace to be configured from the submenu
The traces dialog box displays (Figure 8-14).

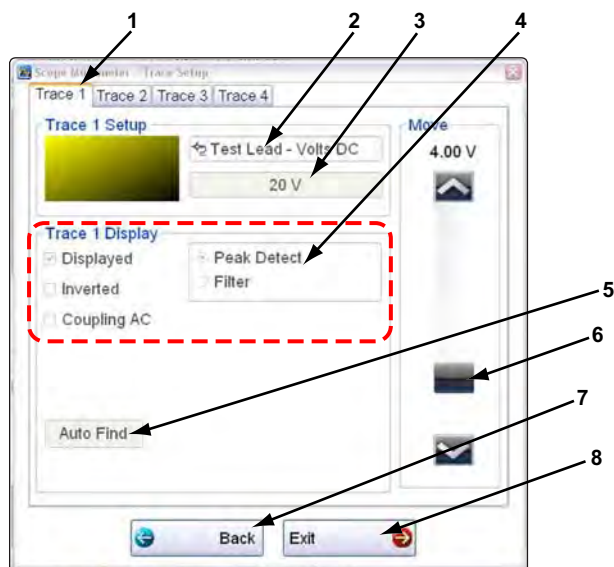

- 1— Trace tabs
- 2— Trace Probe icon
- 3— Trace Scale icon
- 4— Trace characteristics check boxes
- 5— Baseline position
- 6— Auto Find icon
- 7— Back icon
- 8— Exit icon

Figure 8-14 Traces dialog box

4. Select the **Trace Probe** icon to open the menu.
5. Highlight a probe on the list and select **OK** to close the window.
6. Select the **Trace Scale** icon to adjust the vertical scale, of the display.
A dropdown menu opens, menu options vary depending upon which test lead is selected.
7. Select a trace scale option, then close the window.
8. Select or deselect the trace characteristic items as needed:
 - **Displayed**—this trace is on screen when checked, and not visible when not checked.
 - **Inverted**—signal polarity is reversed when checked, normal when not checked.

- **Coupling AC**—check when sampling an AC signal, uncheck for DC signals.
 - **Peak Detect**—use when trying to capture a fast event or signal glitch.
 - **Filter**—use when radio frequency interference (RFI) may be disrupting the signal.
9. The scope samples the signal and internally calculates the best way to display it when **Auto Find** is selected. A scale and the vertical position for the zero line of the trace that allows the whole waveform to fit on the screen is established when Auto Find is selected. If Auto Find is selected on the trigger channel, it also sets the trigger level halfway between the minimum and maximum value of the sampled signal to provide a stable waveform.
 10. The baseline position is the zero line of the trace, use the slider and arrows to adjust it.
 11. Select **Back** to return to the Preferences dialog box, or select **Exit** to close the dialog box and return to the scope.

Sweep Controls

Sweep is the amount of time represented by the screen, or the horizontal scale of the display.



To adjust Sweep controls:

1. Select **Setup** from the Scope Multimeter toolbar.
The Scope Multimeter Preferences dialog box opens.
2. Select **Sweep** icon to open the sweep dialog box (Figure 8-15)

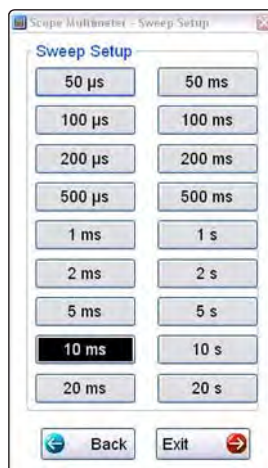

Figure 8-15 Sample Sweep Setup dialog box

3. Choose an option from the list.
4. Select **Back** to return to the Preferences dialog box, or select **Exit** to close the dialog box and return to the scope.

Trigger Controls

Triggering allows you to set the scope so that it only begins displaying a trace once predetermined signal conditions, or triggers, are met. The trigger point is indicated by a plus sign (+) on the scope grid. The plus sign can be dragged across the grid with the stylus to roughly position it. The trigger controls allow you to precisely position the trigger.



To adjust trigger controls:

1. Select **Setup** from the Scope toolbar. The Scope Multimeter Preferences dialog box opens.
2. Select **Trigger** to open the Trigger Setup dialog box (Figure 8-16).
3. Use the dialog box controls to establish the position for triggering.
4. Select **OK** to close the dialog box.
5. Select **Back** twice to close the Scope Multimeter Preferences dialog box.

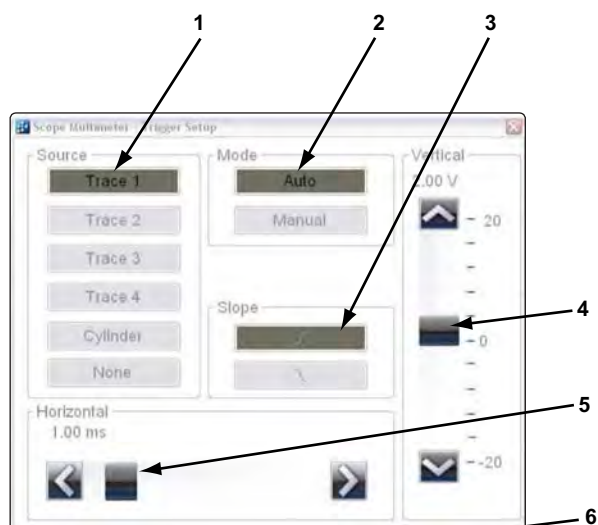

1— Source—selects the triggering event:

- Trace 1—sets the trigger to channel 1.
- Trace 2—sets the trigger to channel 2.
- Trace 3—sets the trigger to channel 3.
- Trace 4—sets the trigger to channel 4.
- Cylinder—sets triggering to the firing of a cylinder detected by the optional RPM Pickup or Secondary Ignition Adapter.

2— Mode—sets the method of triggering:

- Auto (automatic)—if a trigger is found, the waveform displays. If a trigger is not found after about a half second, the waveform and a “trigger not found” message displays.
- Manual—if a trigger is found, the waveform displays. If a trigger is not found nothing displays (no waveform and no message).

3— Slope—sets triggering to the rising (top icon) or falling (lower icon) slope of the signal waveform.

4— Vertical position—moves the trigger position up and down on the grid.

5— Horizontal position—moves the trigger timing left and right on the grid

6— Select **Back** to return to the Preferences dialog box, or select **Exit** to close the dialog box and return to the scope.

Figure 8-16 Trigger controls

View Controls

Use the view controls to set display attributes.



To adjust view controls:

1. Select **Setup** from the Scope Multimeter toolbar.

The Scope Multimeter Preferences dialog box opens.

2. Select View to open a submenu.

Three types of adjustment are available on the submenu:

- **Display**—use to adjust what information displays and how it appears
- **Layout**—use to set how many and how the traces display on the screen
- **Units**—use to adjust time and voltage interval settings

Selecting from the submenu opens a dialog box for that item. Dialog box options for each item are discussed in the following sections.

3. Make dialog box selections as needed.

4. Select **Back** to return to the Preferences dialog box, or select **Exit** to close the dialog box and return to the scope.

Display Settings

Selecting **Display** from the View submenu opens the Display dialog box (Figure 8-17).

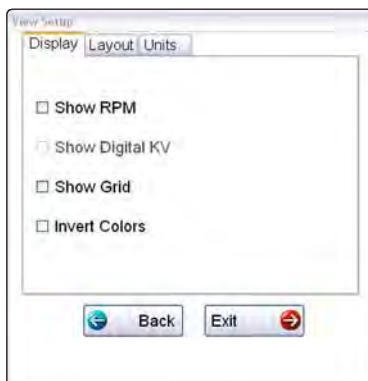

Figure 8-17 Sample Display dialog box

The following options are available from the Display dialog box:

- **Show RPM**—adds an engine speed field at the top of the screen (Figure 8-18).

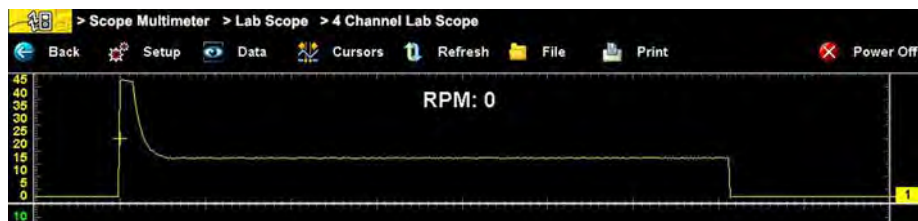

Figure 8-18 Sample Show RPM selected

- **Show Digital KV**—available only in ignition scope, adds a kilovolt reading to the screen.
- **Show Grid**—switches grid lines on the screen off and on (Figure 8-19).

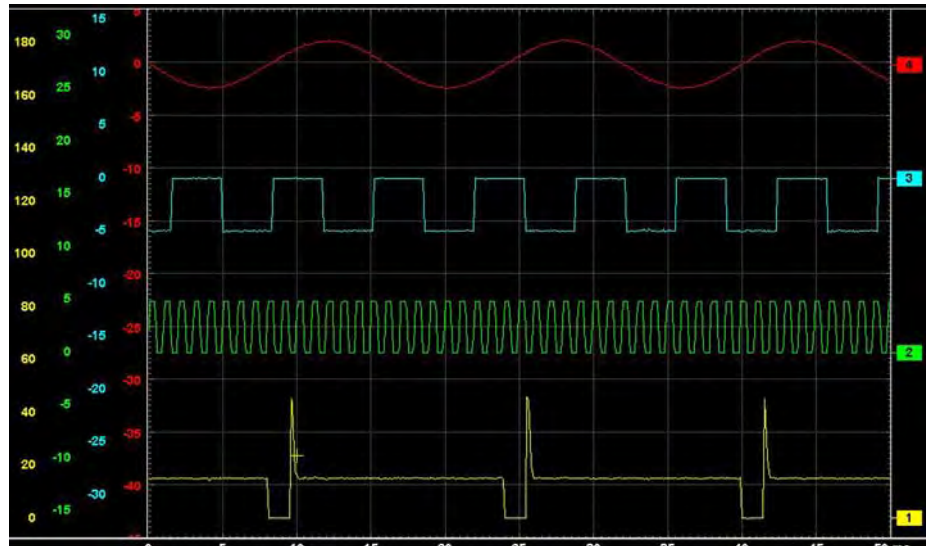

Figure 8-19 Sample grid selected

- **Invert Colors**—switches the screen background to white.

Layout Settings

The selected radio knob on the Layout dialog box shows which setting is active. Use a finger or the stylus to switch between settings:

- **1 window**—shows all traces on the same screen (Figure 8-19).
- **2 windows**—shows two separate traces in two ways: horizontal, one below another (Figure 8-20) or vertical, side-by-side (Figure 8-21)

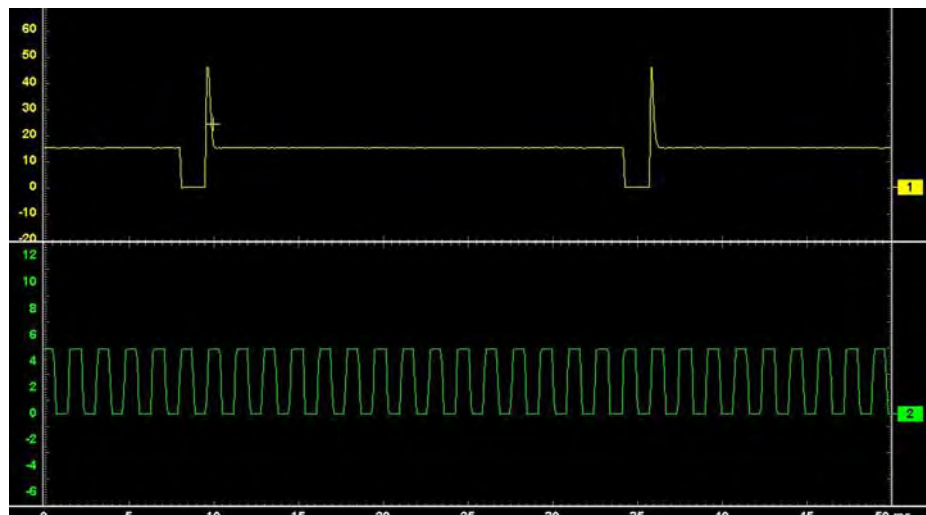

Figure 8-20 Sample 2 Windows horizontal display

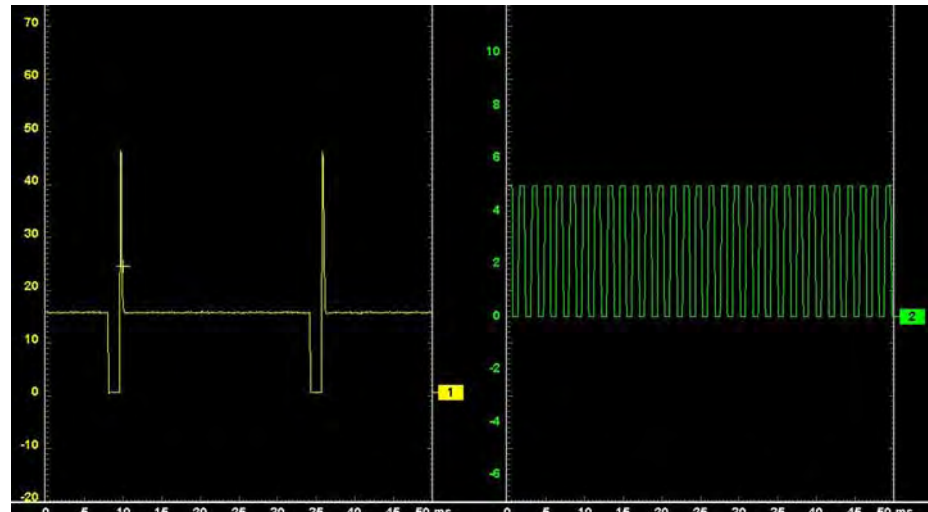

Figure 8-21 Sample 2 Windows vertical display

- **3 windows**—shows three traces, one below another, on the same screen (Figure 8-22).

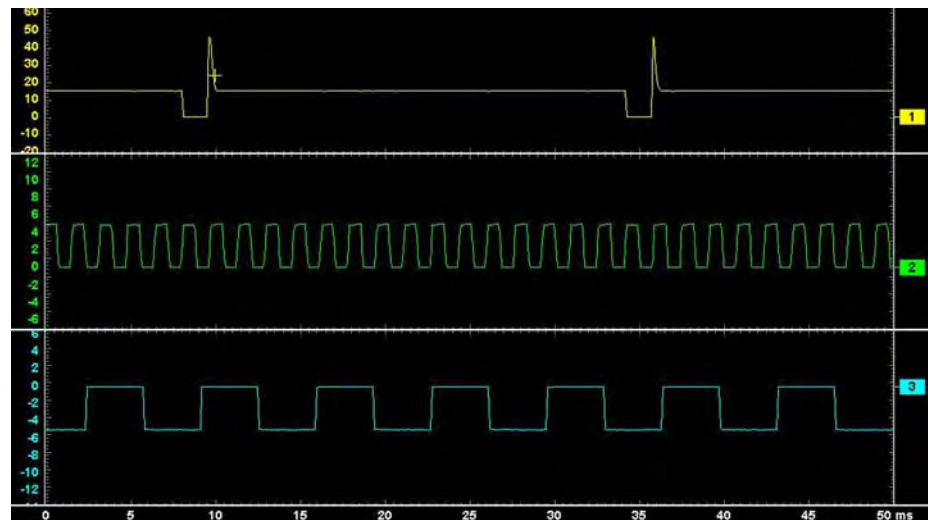

Figure 8-22 Sample 3 Windows display

- **4 windows**—shows four traces, one below another, on the same screen.

Units Settings

The Units dialog box allows you to switch between Full Scale or Per Division settings for the trace setup and the display settings. Selecting Full Scale configures the units to the full viewing area of the screen, while Per Division adjusts the units to a single division (one tenth) of the screen.

The selected radio knob on the Units dialog box shows which setting is active. Use a finger or the stylus to switch between settings (Figure 8-23).

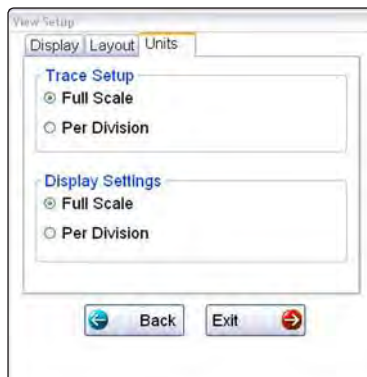

Figure 8-23 Sample View Units dialog box

Setup Controls

Basic tool settings are adjusted here.



To adjust setup controls:

1. Select **Setup** from the Scope Multimeter toolbar.
The Scope Multimeter Preferences dialog box opens
2. Select **Setup** from the dialog box.
A submenu of options displays:
 - **Units**—use to set how measurement values display, US standard or metric
 - **Snapshot**—use to adjust the percentage of data captured following a trigger event
 - **Ignition**—use to configure the optional ignition scope for the test vehicle
 Selecting from the submenu opens a dialog box for that item. Dialog box options for each item are discussed in the following sections.
3. Make dialog box selections as needed.
4. Select **Back** to return to the Preferences dialog box, or select **Exit** to close the dialog box and return to the scope.

Unit Setup

The units of measurement can be changed between US standard or metric units of measure for pressure and vacuum readings. The table below shows available unit values.

Abbreviation	Description
bar	bar
inHg	inches of mercury

Abbreviation	Description
kg/cm2	kilograms per centimeter squared
kPa	kilopascal
mmHg	millimeters of mercury
psi	pounds per square inch

Selecting Units opens the Setup dialog box. The selected radio knobs on the Setup dialog box show which settings are active (Figure 8-24).



Figure 8-24 Sample Setup Units dialog box

Snapshot

The Snapshot tab of the Setup dialog box opens a window that allows you to select how much data is captured after a snapshot is triggered (Figure 8-25). Available selections, which range from ten to ninety percent in ten-percent increments, are shown as icons with the current setting highlighted. Select a icon, then select **OK** to close the dialog box.

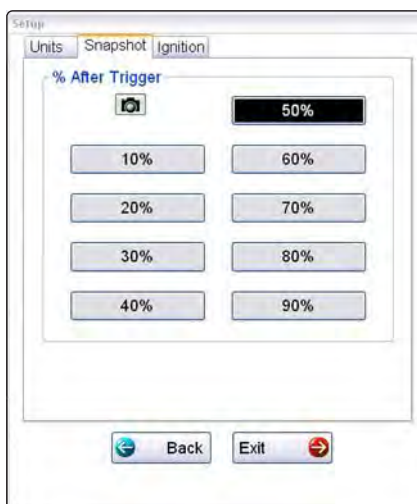

Figure 8-25 Sample Snapshot dialog box

Refer to [Trigger Controls](#) on page 102 for information on how to setup a trigger.

Ignition

The Ignition tab of the Setup dialog box is used to configure the scope for displaying secondary ignition patterns. There are two main selection fields (Type and Cylinders) and two fields that vary depending upon the type of ignition system selected in dialog box (Figure 8-26).



Figure 8-26 Sample Setup Ignition dialog box



To setup Ignition tests

1. Select the **Setup** icon to open the Setup dialog box.
2. Select the **Ignition** tab of the dialog box.
3. Highlight the ignition system for the test vehicle in the “Type” field:
 - **Standard**—use for systems with a distributor
 - **Waste Spark**—use for coil pack systems that fire 2 plugs simultaneously
 - **Direct**—use for coil-on-plug systems
 - **Other**—use for systems that do not fit any of the above categories
4. Select the number of cylinders for the test vehicle in the “Cylinders” field.
Scroll through the list using the up and down arrows on either side of the number.
5. This step varies depending upon the type of ignition system:
 - If testing a Standard system, select the Firing Order.
 - If testing an Other system, select the RPM Factor.
Scroll through the list of available choices using the up and down arrows below the displayed firing order or RPM factor.
6. This step also varies depending upon the type of ignition system:
 - If testing a Standard or Direct system, choose between Coil and Plug for the Number 1 Trigger.
 - If testing a waste Spark system, select the polarity of the firings using the +, –, and arrow icons.
7. Select **Back** to return to the Preferences dialog box, or select **Exit** to close the dialog box and return to the scope.

Data

The **Data** icon on the toolbar switches the trace details information at the base of the screen as previously in [Trace Details](#) on page 94.

Cursor Controls

The cursor controls include a Show Cursors check box plus a slide control and arrows for moving the cursor position left or right. Select **Cursors** from the toolbar to open the Cursors dialog box ([Figure 8-27](#)).

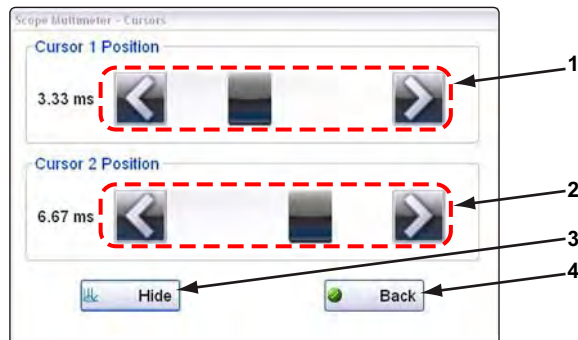

- 1— Cursor 1 controls
- 2— Cursor 2 controls
- 3— Show or Hide icon
- 4— Back icon

Figure 8-27 Cursor controls

Cursor 1, the top slider and arrows, is the left-hand cursor on the screen. Cursor 2, the lower set of controls, is the right-hand cursor on the screen. Drag the slider or select the arrows to position the cursors. Each tap of the stylus moves the cursor incrementally in the direction of the arrow.

- Select **Show** to display the cursors (the icon changes to Hide).
- Select **Hide** to conceal the cursors (the icon changes to Show).
- Select **Back** to close the dialog box.

Refresh Controls

Selecting the **Refresh** icon from the Scope Multimeter Toolbar clears the minimum and maximum digital values and updates the viewing screen.

File Controls

Selecting **File** from the toolbar opens a dialog box with a menu of save options:



Figure 8-28 Sample file setup dialog box

- **Save Configuration**—saves the current setup values as a preset.
- **Save Single Frame**—saves the data currently on the screen only.
- **Save All Frames**—saves the current screen plus all the data stored in the buffer.



To save a file or configuration:

1. Select **File** from the toolbar.
2. Select a save option from the dialog box.
The Save As dialog box and the virtual keyboard open.
3. Use the keyboard to name the file to be saved, then either select the **Save** icon or select **return** on the keyboard.



Figure 8-29

A configuration description dialog box opens.



NOTE:

The description entered here is what displays in the information panel of the Data Manager.

4. Use the keyboard to enter a description of the file to be saved.
5. Select the **OK** icon or select **return** on the keyboard.
6. Select **OK** to close the file setup dialog box.

Once a configuration is saved, it becomes available as a preset. Files are saved to the Scope Multimeter Data Folder and can be retrieved through the **Data Manager**.

Print Controls

Selecting Print from the toolbar opens a standard Windows Print dialog box set up to print the current screen. A printer must be connected and setup on the diagnostic tool. If not, the “Add Printer Wizard” opens and guides you through the procedure. Select from the menus as needed.

The Repair Information icon (Figure 9-1) can be used to:

- Access the SureTrack® Community within ShopKey® Pro that is included with current diagnostic tool software, see [SureTrack](#) on page 150 for additional information.
- Access optional online repair resources (e.g. ShopKey® Pro)

As an example, after using the Scanner, Guided Component Test, or Scope Multimeter to diagnose and locate the source of a problem, you can select the **Repair Information** icon on the Home screen to link to online repair resources that can help you further research and diagnose the vehicle specific problem, to get the vehicle back in service quickly.



Figure 9-1 Repair Information icon

9.1 About ShopKey Pro

ShopKey Pro is an optional online service that can provide you with OEM repair, estimating, maintenance, and real-world experience-based information to help you efficiently and accurately perform repairs. It allows you access to OEM TSB's, recall, repair, campaign, and diagnostic information, as well as wiring diagrams, maintenance schedules, expert information and more all from one source!

Searching for repair information is easy, as the search process is based on vehicle components, so it matches the repair process. Simply look up a component and ShopKey Pro returns only the relevant repair information, including TSBs, component location, specifications, operating values, removal and installation procedures, wiring diagrams, and more.

Listed below are a few of the main features that ShopKey Pro has to offer:

- **Safety Recalls, OEM Campaigns and TSBs**—This information is automatically displayed based on the identified vehicle and component search, so you don't have to perform separate searches.
- **Wiring Diagrams**—Full-color diagrams are easy to follow, and the circuit trace feature allows you to highlight a complete circuit from end-to-end to quickly identify the specific circuit you are testing.
- **Diagnostics**—Enter a DTC to find the information needed to diagnose and fix the problem, including code descriptions, setting conditions, component illustrations and test procedures.
- **Maintenance**—The maintenance schedules are straightforward so anyone in the shop can sell services and grow a profitable maintenance business. You get lifetime service schedules, procedures, specifications; and a unique component locator tab shows exactly where to begin the maintenance procedure.

- **SureTrack®**—SureTrack is a comprehensive source of expert knowledge for professional technicians, combining diagnostic experience and detailed parts replacement records, all wrapped in an interactive community.
- **ShopKey Pro Vintage**—ShopKey Pro Vintage includes an extensive library of engine and chassis repair information, along with wiring diagrams, and other information for vehicles back to 1960.

Contact your Snap-on representative to learn more about ShopKey® Pro or visit the following web pages:

- [Snap-on Diagnostics ShopKeyPro Page](#)
- [ShopKeyPro.com](#)
- [ShopKey Pro Training \(sktraining.net\)](#)

Vehicle History allows you to manage and retrieve vehicle records, for vehicles that have been scanned or identified previously. You can also activate a vehicle, so there is no need to go through the complete vehicle identification sequence when performing a retest after repairs have been made.

10.1 Screen Layout

There are two main parts to the vehicle records list screen:



- 1— Vehicle History Toolbar
2— Main Body (Records List)

Figure 10-1 Vehicle records list screen

10.1.1 Vehicle History Main Body (Records List)

The main body of the screen lists all of the available vehicle records. By default, records are shown in the order in which they are entered. However, you can resort them by any of the categories shown as column headings. You can also resize the individual columns.



To sort records:

1. Select a category heading.
The listed items resort according to the selected category. A triangle appears alongside the name of the column that was used for the sort.
2. Select the triangle in the heading to reverse the sort order.



To resize a column:

1. Select the line separating two columns.
A line with arrowheads appears to show the column is ready for resizing.
2. Drag the line left or right to increase or decrease the column width.

10.1.2 Vehicle History Toolbar

The table below gives brief descriptions of the control icons on the toolbar:

Table 10-1 *Toolbar icons*

Name	Icon	Description
Back		Returns to the previously viewed screen.
Activate		Activates the selected vehicle, for use with other functions (e.g. Scanner, Guided Component Tests, etc).
View		Opens the selected vehicle record.
Delete		Deletes the selected vehicle record from memory.
Manage		Opens the vehicle Manage Records screen.
Search		Opens a window that allows you to locate a particular vehicle record.
Show All		Available only after a search, use to return to a complete vehicle records list.
Settings		Opens a window that allows you to configure which fields display on main records list screen.

Activate

Use this icon to activate a vehicle for use in other functions (e.g. Scanner, Guided Component Tests, etc.). The diagnostic tool will use the identification information stored in the vehicle history record to load the correct vehicle database, so there is no need to identify the test vehicle again.



To activate a vehicle:

1. Locate and highlight the desired vehicle record on the records list screen.
2. Select **Activate** from the toolbar.
The Activate icon is removed from the toolbar once a vehicle has been selected.
3. Select the **Home** icon.
The Home screen displays with the activated vehicle shown on the toolbar.
4. Select any Function icon on the Home screen to begin testing.

View

Select **View** to open, edit, add notes, and print a vehicle record.



To open and/or modify a vehicle record:

1. Highlight the desired vehicle record from the vehicle records list screen, then double click it, or select **View** from the toolbar.

The record for the selected vehicle opens (Figure 10-2).

The vehicle record includes vehicle ID information, DTC data, and other data entry fields for owner and vehicle information, and technician notes. Depending on the vehicle information that was used to identify the vehicle, some data may be already entered. The example below shows, DTC scan results from the last code scan performed, and an attachment “Vehicle System Report Data” PDF file.

Vehicle ID information is captured slightly different across the different functions (e.g. Scanner, Guided Component Tests, etc.), as some functions may capture more/less information during the process. Selecting the **Other Vehicle ID** button, opens a listing of the captured vehicle ID fields from each applicable function. If more than one function was used to ID the vehicle, you are given the option to use that vehicle ID set as the default ID for the vehicle record.

Figure 10-2 Sample vehicle record



NOTE:

The virtual keyboard automatically opens the first time you select within one of the data fields.

2. Use the virtual keyboard to enter information in the data fields. The data is automatically saved.
3. Select **Back** to return to the vehicle records list screen.

Delete

Select **Delete** to remove unwanted items from the vehicle records list. Highlight the record to remove, then select **Delete**.

Manage

Select **Manage** to quickly remove individual records, or all the vehicle records from the vehicle records list. Highlight the record to remove, then select **Delete**, or use the Select All or Deselect All options to remove all records (Figure 10-3).

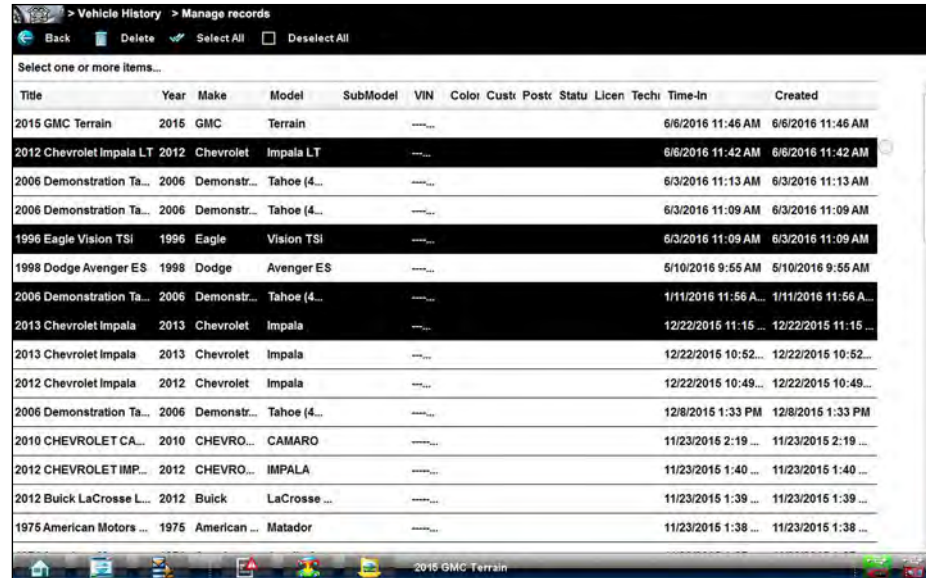

Title	Year	Make	Model	SubModel	VIN	Color	Custr	Post	Statu	Licen	Techn	Time-In	Created
2015 GMC Terrain	2015	GMC	Terrain		----							6/6/2016 11:46 AM	6/6/2016 11:46 AM
2012 Chevrolet Impala LT	2012	Chevrolet	Impala LT		----							6/6/2016 11:42 AM	6/6/2016 11:42 AM
2006 Demonstration Ta...	2006	Demonstr...	Tahoe (4...		----							6/3/2016 11:13 AM	6/3/2016 11:13 AM
2006 Demonstration Ta...	2006	Demonstr...	Tahoe (4...		----							6/3/2016 11:09 AM	6/3/2016 11:09 AM
1996 Eagle Vision TSi	1996	Eagle	Vision TSi		----							6/3/2016 11:09 AM	6/3/2016 11:09 AM
1998 Dodge Avenger ES	1998	Dodge	Avenger ES		----							5/10/2016 9:55 AM	5/10/2016 9:55 AM
2006 Demonstration Ta...	2006	Demonstr...	Tahoe (4...		----							1/11/2016 11:56 A...	1/11/2016 11:56 A...
2013 Chevrolet Impala	2013	Chevrolet	Impala		----							12/22/2015 11:15 ...	12/22/2015 11:15 ...
2013 Chevrolet Impala	2013	Chevrolet	Impala		----							12/22/2015 10:52...	12/22/2015 10:52...
2012 Chevrolet Impala	2012	Chevrolet	Impala		----							12/22/2015 10:49...	12/22/2015 10:49...
2006 Demonstration Ta...	2006	Demonstr...	Tahoe (4...		----							12/8/2015 1:33 PM	12/8/2015 1:33 PM
2010 CHEVROLET CA...	2010	CHEVRO...	CAMARO		----							11/23/2015 2:19 ...	11/23/2015 2:19 ...
2012 CHEVROLET IMP...	2012	CHEVRO...	IMPALA		----							11/23/2015 1:40 ...	11/23/2015 1:40 ...
2012 Buick LaCrosse L...	2012	Buick	LaCrosse ...		----							11/23/2015 1:39 ...	11/23/2015 1:39 ...
1975 American Motors ...	1975	American ...	Matador		----							11/23/2015 1:38 ...	11/23/2015 1:38 ...

Figure 10-3

Search and Show All

Selecting Search opens a dialog box that allows you to search vehicle records by category. You can search for data in the following categories:

- Year
- Make
- Model
- Color
- Customer
- License
- State
- Technician



To search:

1. Select **Search** from the toolbar.
2. Enter the search criteria in the text field (Figure 10-4).

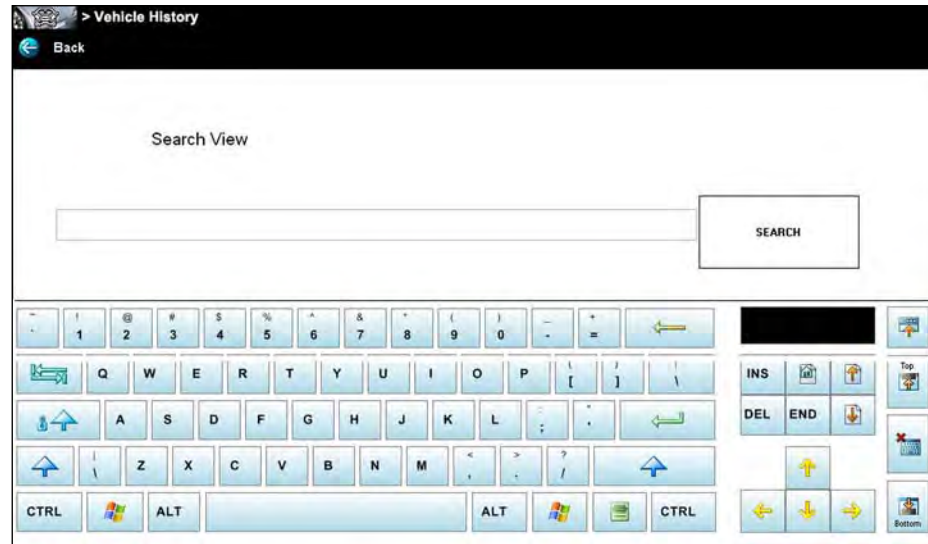

Figure 10-4 Sample Search dialog box

3. Select **Search** twice. The first tap closes the keyboard, the second tap starts the search. The display returns to the vehicle records list screen with only the records found in the search criteria showing.
4. Select **Show All** on the toolbar to restore the complete vehicle records list.

Settings

Use Settings to determine which categories display on the vehicle records list screen. Selecting the Settings icon opens a vehicle history category display menu.



To change Settings:

1. Select **Settings** to open the menu.

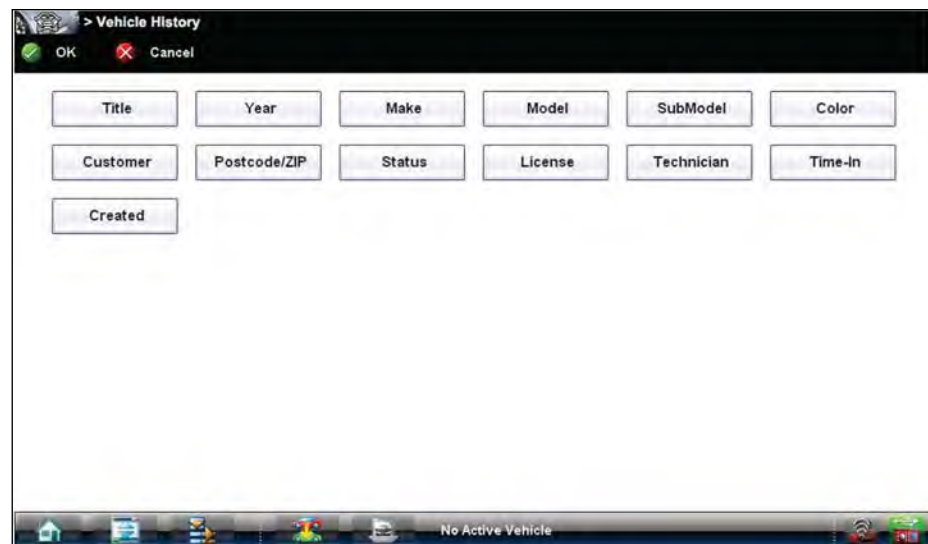

Figure 10-5 Sample Settings dialog box.

2. Select or deselect the desired categories:
 - Highlighted items - do not display
 - Non-highlighted items - display
3. Select **OK** on the toolbar to accept the changes, and return to the previous screen.

The Data Manager is used to store, sort, and review saved files. Most operations are controlled through the toolbar.

11.1 Screen Layout

Select **Data Manager** on the Module toolbar to open the file system. Use the toolbar at the top of the screen to navigate through the data. The folders panel below the toolbar displays the contents of the Windows *My Documents* > *ShopStream* folder, which is the Data Manager main screen. The information panel on the lower-left portion of the screen shows a summary of the saved file when available, and the preview panel on the lower right displays an image if the selected file is a graphic.

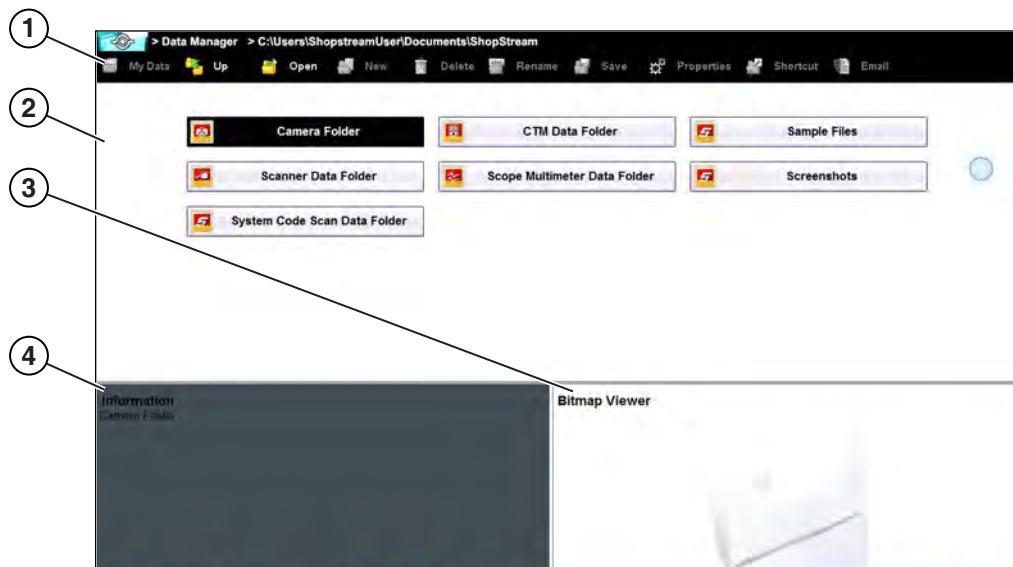

- 1— Data Manager Toolbar
- 2— Folders Panel
- 3— Preview Panel
- 4— Information Panel

Figure 11-1 Sample Data Manager main screen

The main screen includes folders for saved files from the various modules:









- Camera Folder—contains photographs taken with the built-in camera. See [Image Viewer](#) on page 143.
- CTM Data Folder—contains files saved while working in the Guided Component Test module. See [Scope Viewer](#) on page 142.
- Sample Files—contains an assortment of example saved data files.
- Scanner Data Folder—contains files saved while working in the Scanner function. See [Scanner DataViewer Operation](#) on page 132.

- Scope Multimeter Data Folder—contains files saved while working with the Scope Multimeter. See [Scope Viewer](#) on page 142.
- Screenshots—contains images saved by pressing the Shortcut (S) button. See [Image Viewer](#) on page 143.

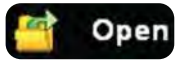
11.2 Navigation

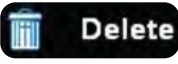
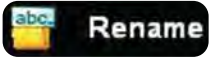
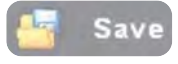
Use the toolbar icons as shown in the table below to navigate through the Data Manager:

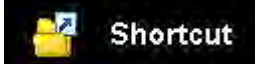
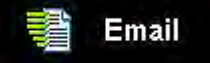
Table 11-1 Data Manager toolbar icons

Name	Icon	Description
My Data	 My Data	Returns to the Data Manager main screen.
Up	 Up	Moves the items displayed in the folders panel up one level in the file structure.
Open	 Open	Opens the highlighted folder or file.
New	 New	Creates a new folder.
Delete	 Delete	Moves the highlighted file or folder to the recycling bin.
Rename	 Rename	Opens a dialog box and the virtual keyboard for renaming the selected file or folder.
Save	 Save	The Save function is not implemented at this time.
Properties	 Properties	Opens a dialog box and the virtual keyboard for renaming the selected file or folder.
Shortcut	 Shortcut	Creates a shortcut to the highlighted item on the Data Manager main screen. See Shortcut on page 125 for information.
Email	 Email	Send data files as attachments, using Email. See Email on page 126 for information.
More (optional)		Opens hidden menu options

11.3 Operations

Data Manager operations based on toolbar selections are explained in the following sections.

11.3.1 My Data

The My Data icon is a shortcut that quickly returns you to the main Data Manager screen. Select the icon at any time to instantly return. Note the location of the page being viewed is shown near the top of the screen just above the toolbar.

11.3.2 Up

This icon reflects the items shown in the folders panel of the screen up in the file structure one level at a time. For example; one tap of the Up icon when viewing the contents of the Scanner Data Folder returns you to the main screen. A second tap would display the contents of the “My Documents” folder.

11.3.3 Open

The Open icon is only active (displays in color) when an item in the folders panel is highlighted.



To open a folder:

1. Highlight the file to open in the folders panel.
2. Select the **Open** icon to load the highlighted file.

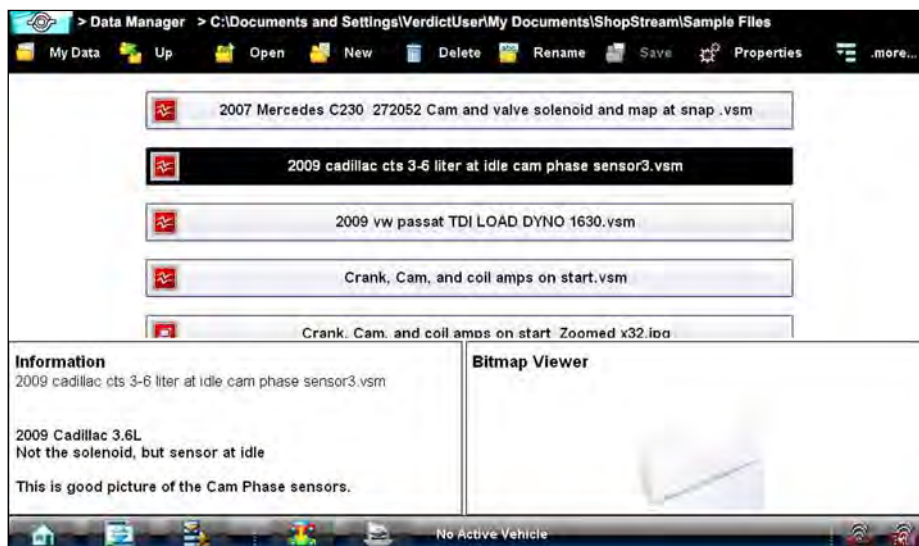

Figure 11-2 Sample open folder showing information

The screen advances and the contents of the open folder are shown in the folders panel. Highlight an item in the folders panel and the information or preview displays, if available, in the lower portion of the screen (Figure 11-2).

3. To exit the current folder:
 - Select **My Data** on the toolbar to return to the main Data Manager screen.
 - Select **Up** on the toolbar to return to the previous page.

11.3.4 New

The New icon allows you to create a new folder. This option is only available when the icon displays in color.



To create a new folder:

1. Select the **New** icon on the toolbar.

The New Folder Name dialog box opens (Figure 11-3).
2. Select the entry field on the dialog box to open the virtual keyboard.
3. Type a name for the new folder using the virtual keyboard.
4. Select the **OK** icon to create the new folder and return to the previous page. The **Cancel** icon returns you to the previous page without creating a new folder.



Figure 11-3 Sample New Folder name dialog box

11.3.5 Delete

The Delete icon moves folders or items within folders to the Recycling bin. A confirmation displays when a file is selected for deletion. Select **Yes** to delete the file or **Cancel** to exit.



To delete an item:

1. Select to highlight the item or folder to be deleted.
2. Select the Delete icon on the toolbar.

A confirmation message displays ([Figure 11-4](#)).

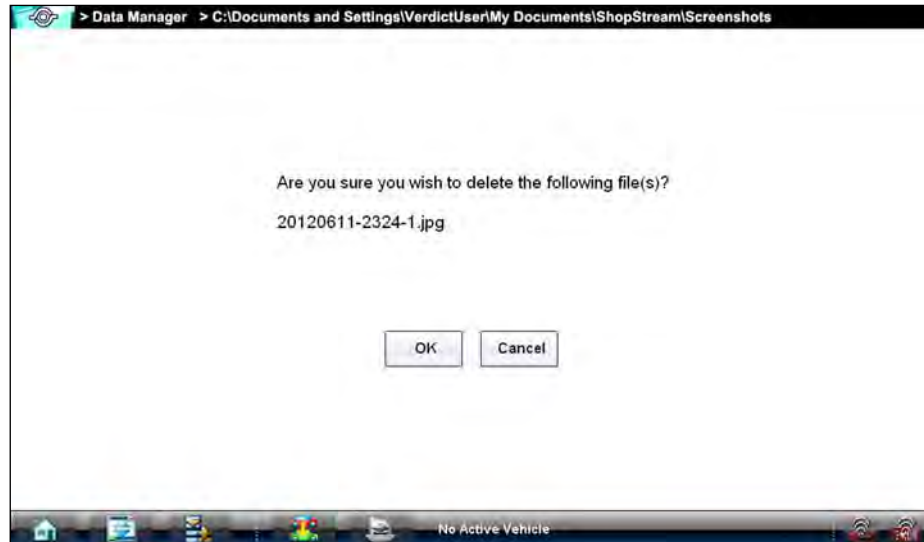

Figure 11-4 Sample delete confirmation message

3. Select **OK** to delete the selected item and return to the previous page. The **Cancel** icon returns you to the previous page without deleting the selected item.

11.3.6 Rename

The Rename icon allows you to change the name of a folder or items within a folder.



To rename an item:

1. Highlight the item or folder to be renamed.
2. Select the **Rename** icon on the toolbar.

The New Name dialog box opens (Figure 11-3).



Figure 11-5 Sample new name dialog box

3. Select the entry field on the dialog box to open the virtual keyboard.
4. Type the new name into the entry field using the virtual keyboard.
5. Select the **OK** icon to change the name and return to the previous page. The **Cancel** icon returns you to the previous page without changing the name.

11.3.7 Properties

The Properties icon function allows you to change the name and assign identifying attributes to saved Scope Multimeter files. Operation is similar to renaming a file as discussed above, except there are additional fields for entering descriptive information.



To assign properties to an item:

1. Highlight the item or folder.
2. Select the **Properties** icon on the toolbar.

The Properties dialog box and the virtual keyboard open (Figure 11-3).



Figure 11-6 Sample Properties dialog box without the virtual keyboard

3. Type a new name into the field using the virtual keyboard if you want to rename the file.
4. Use either the virtual keyboard or the dropdown menus to fill in the Year, Make, Component, and Condition fields.
5. Select the **OK** icon to change the name and return to the previous page. The **Cancel** icon returns you to the previous page without changing the name.

11.3.8 Shortcut

Selecting the **Shortcut** icon creates a shortcut to the highlighted item on the Data Manager main screen. A confirmation message "A shortcut has been created in the default folder for ***sample file name***" displays when this option is selected.

11.3.9 Email

Selecting the **Email** icon from the Data Manager toolbar allows you to send a saved data or image file as an attachment using e-mail. To use this feature, you must install an e-mail client, and then either link your existing e-mail address to the client, or create a new address. The following instructions are intended as a guide only.



To attach a file from a Data Manager folder to an e-mail:



NOTE:

The Email feature uses your system default email client. Refer to Windows Help for instructions on setting your default e-mail client. For an example on how to setup an e-mail client, see [E-mail client installation and setup \(Example\)](#): on page 127.



NOTE:

This diagnostic tool is equipped with Microsoft Outlook Express e-mail client. To use this client, open the Microsoft Outlook Express program and run the New Connection Wizard following the screen prompts, and then either create an e-mail account or use your existing account to complete the setup. You may be required to enter setup information (e.g. incoming and outgoing server names, types, and port values), contact your ISP and/or e-mail provider for additional information.

1. From the Data Manager main screen, select a file from within one of the folders (e.g. Camera, Scanner Data, Scope Multimeter, etc). In this example ([Figure 11-7](#)), a Scope data file was chosen.
2. With the file highlighted, select **Email** from the toolbar.



Figure 11-7

3. A new e-mail message window displays with the selected file attached ([Figure 11-8](#)).



NOTE:

If the e-mail message window does not appear, check the Windows taskbar.

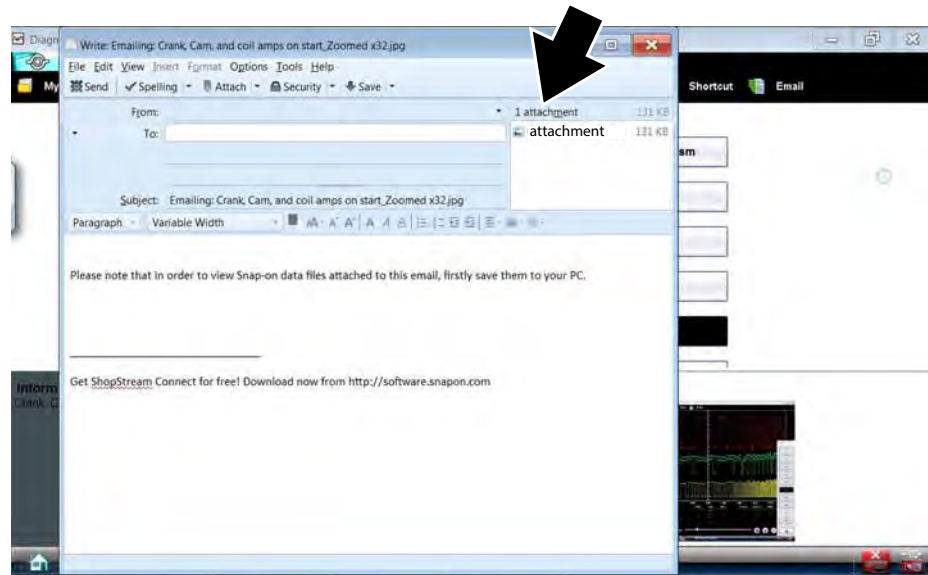

Figure 11-8

4. Enter the e-mail address of the recipient, and any other information needed.
5. Select the **Send** icon to send the e-mail.

**NOTE:**

You must have an Internet connection to send e-mail.

**E-mail client installation and setup (Example):**

The following instructions are intended as a guide only, as e-mail client setup procedures vary.

1. Download an email client (e.g. Mozilla Thunderbird) (Figure 11-9).

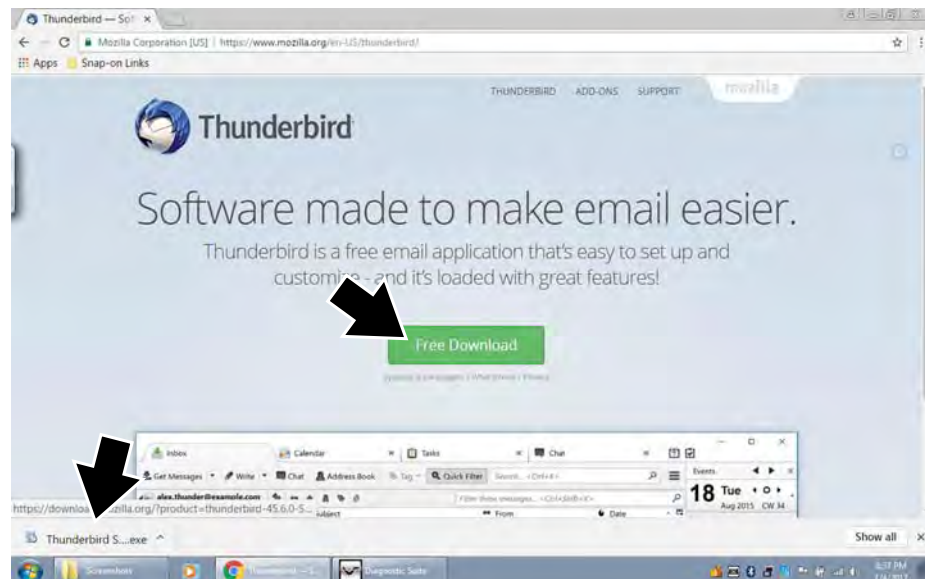

Figure 11-9

2. Install the software following the screen prompts (Figure 11-10).

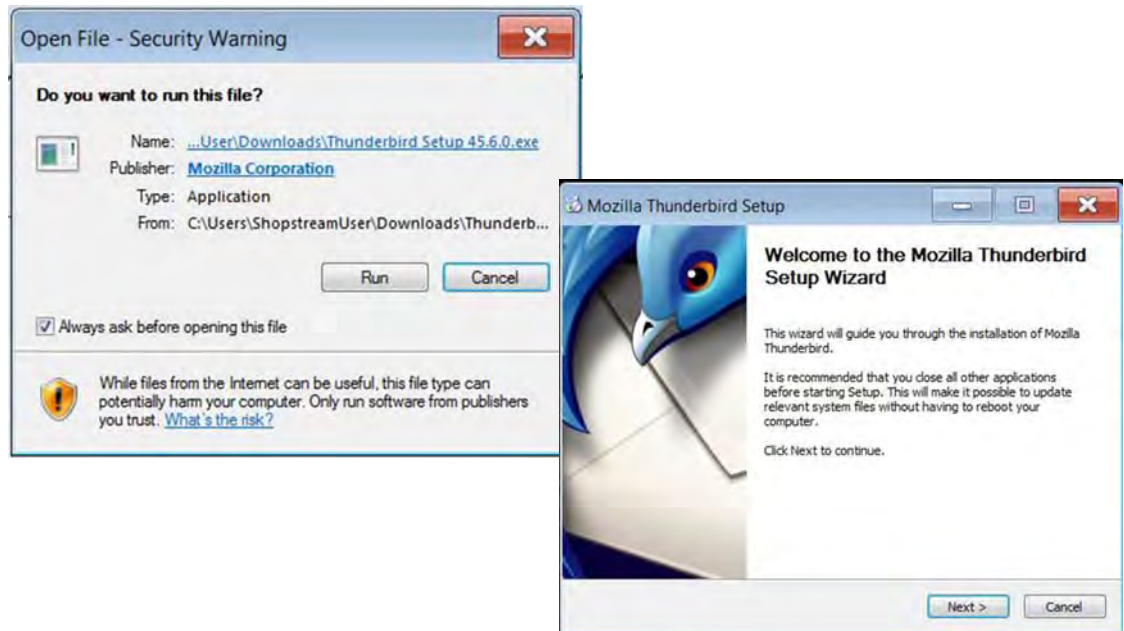

Figure 11-10

3. Continue through the setup. If available choose "set as my default mail application" (Figure 11-11).

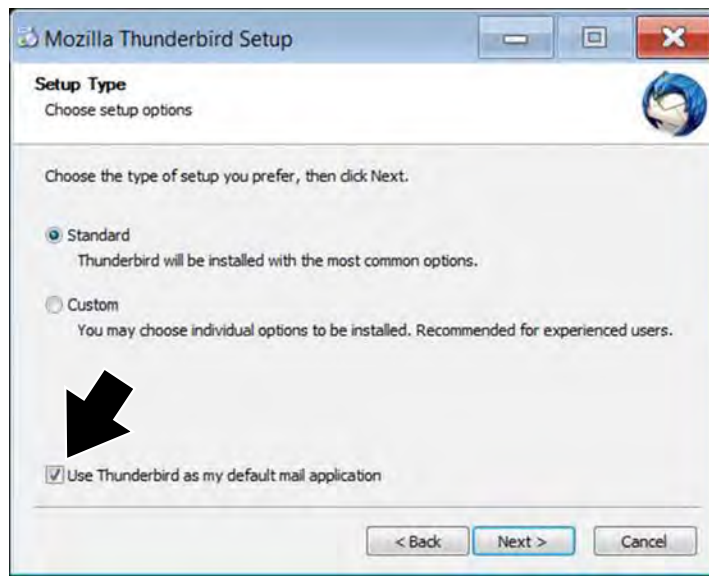

Figure 11-11

4. Choose to use your existing email address, or create a new email address with the email client (Figure 11-12).

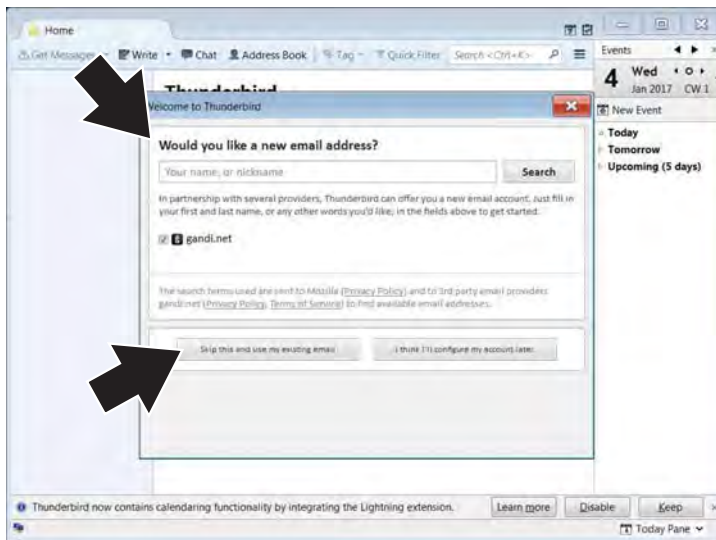

Figure 11-12

5. Enter your e-mail information as required (Figure 11-13).



NOTE:

E-mail client configuration settings should automatically be set during installation. If problems arise with the setup and manual configuration is needed, refer to the e-mail client help information and the Windows help information.



Figure 11-13

6. If your existing email provider login screen displays, enter your email address and password to allow the client to continue the setup with your provider (Figure 11-14).

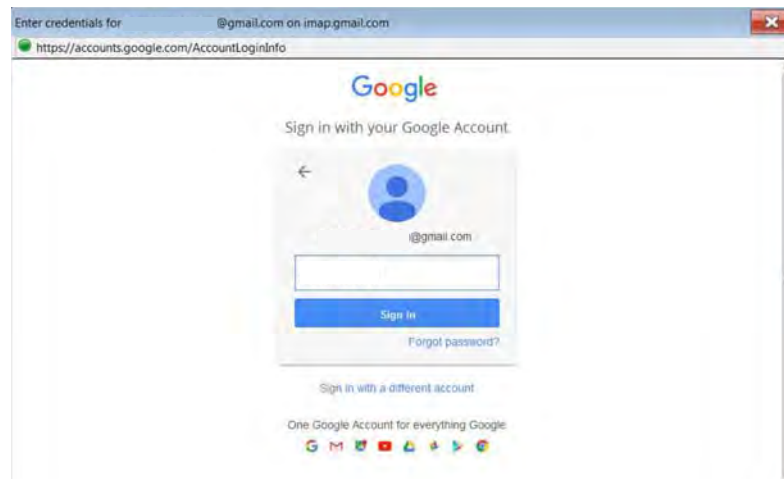

Figure 11-14

7. Follow the screen prompts to allow the client to link to your email address.
8. Once the client has successfully linked to your address, you can begin using the new e-mail client software on the diagnostic tool (Figure 11-15).

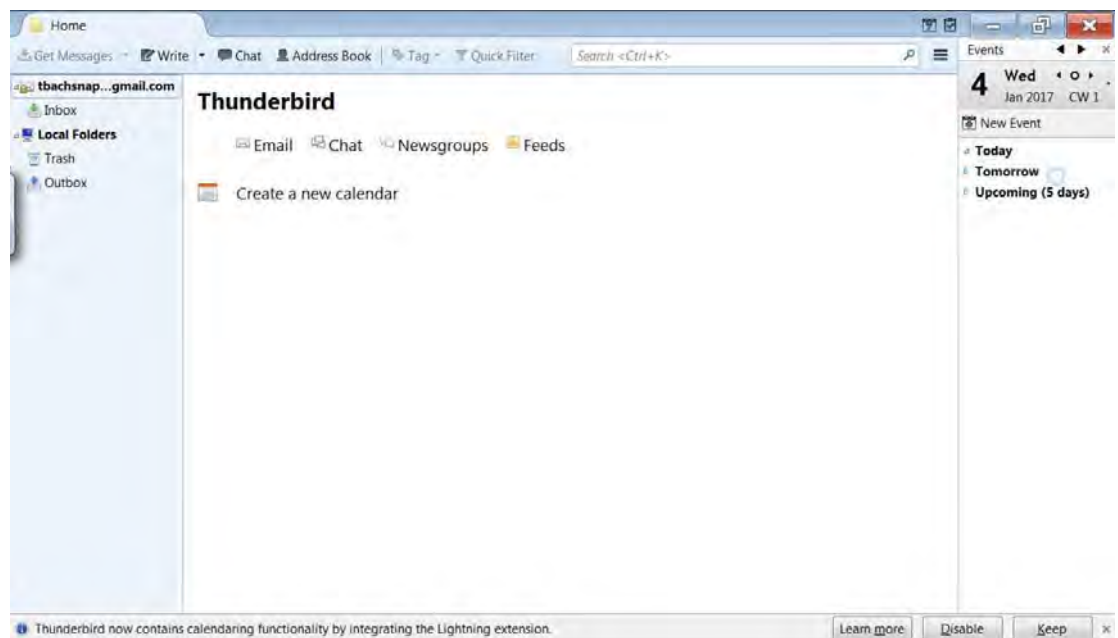

Figure 11-15

11.4 Viewing Saved Files

As mentioned in the beginning of this section, the data and image files in the Data Manager folders are also accessible from the Windows *My Documents* > *ShopStream* folder. You may access, copy or move the files you save in the ShopStream Diagnostic Suite program from the folder at anytime.

The files may also be transferred to portable USB drives and then transferred to your PC. All copy, move and save functions are accomplished using standard Windows operations.

Camera images and screenshots are saved as JPEG files and are viewable on most PCs. Data files are saved using propriety file extensions and are not viewable on a PC without the use of ShopStream Connect. See [ShopStream Connect™](#) on page 131 for additional information.

11.4.1 ShopStream Connect™

Data files saved on your diagnostic tool are designed and intended to be reviewed using the Data Manager functions as described earlier. An alternative method can be used to review select data files on a PC using ShopStream Connect.

ShopStream Connect is PC-based program that allows you to manage, view and print data files using a PC. ShopStream Connect is a free program available for download from our website. See the contact information at the front of this manual for website information.

11.5 Saved File Structure

The Diagnostic Suite automatically creates folders to manage saved files. Whenever 60 files are saved into any of the Data Manager menu option folders, a new folder is created. Folders may contain files for a day, week, month, or a year. An older folder, when available, goes to the next higher level in the files structure menu ([Figure 11-16](#)).

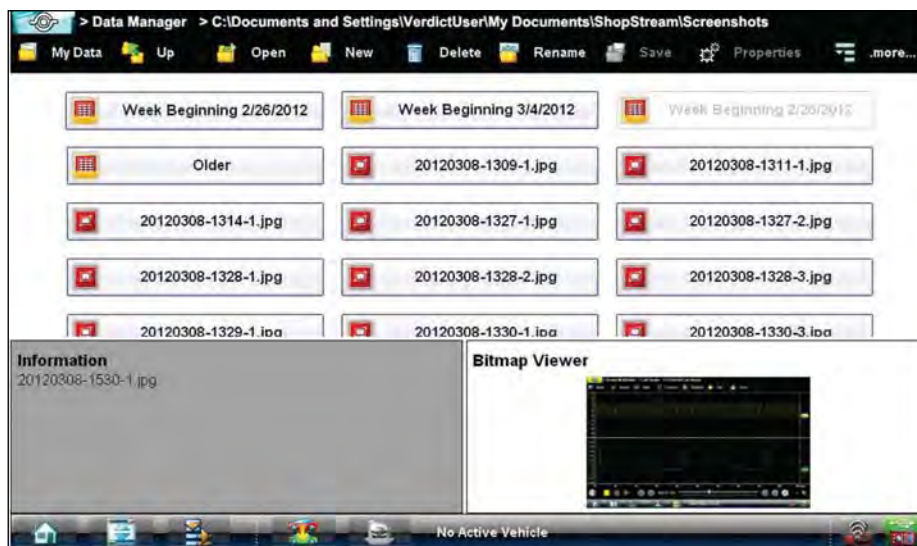
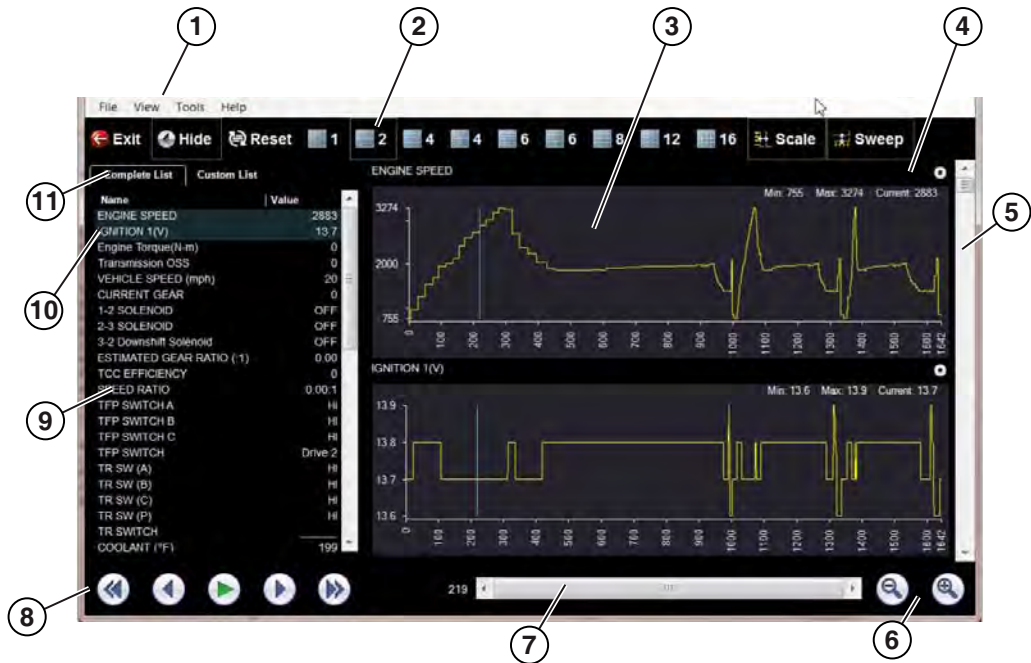

Figure 11-16 Sample saved file folder structure

11.6 Scanner DataViewer Operation

The Scanner DataViewer allows you to review saved scanner data files (Figure 11-17). To open saved Scanner data files, select the **Scanner Data Folder** menu option from the Data Manager main menu.

Scanner DataViewer - Opens .pids, .scm, .scs, .scp and .spm file extensions



- 1— Menu bar
- 2— Display toolbar
- 3— Graph display
- 4— Properties icon
- 5— Vertical Scroll bar
- 6— Zoom controls
- 7— Slider bar
- 8— Navigation toolbar
- 9— Parameter text list
- 10—Parameter configuration tabs

Figure 11-17 Scanner Data Viewer

11.6.1 Menu Bar

The menu bar at the top of the screen contains the File, View, Tools, and Help menus.

File Menu

The File menu offers the following selections:

- **Load**—locate and open data files, launches a navigation window
- **Print**—print selected pids
- **Print Preview**—preview pids before printing
- **Exit**—closes Scanner DataViewer

When Print or Print Preview is selected, a dialog box opens and allows you to define the printed output. Print settings include, print as graphs or text, which pids to include, number of pids per page, display colors, and the text font (Figure 11-18).



Figure 11-18 Pids print settings



To print:

1. Select the desired pids. A checked box indicates the pid will be printed. Select again to deselect the pid.
2. Select Change to modify the font, this opens a standard Windows font dialog box.
 - a. Modify the font as desired.
 - b. Select **OK** to close the font dialog box.
3. Once all selections are made, select **OK**.
A print dialog box opens.
4. Select **OK**.
 - a. If Print was selected, the file is sent to the printer.
 - b. If Print Preview was selected, a preview window opens. Select the printer icon (Figure 11-19) to send the file to the printer.

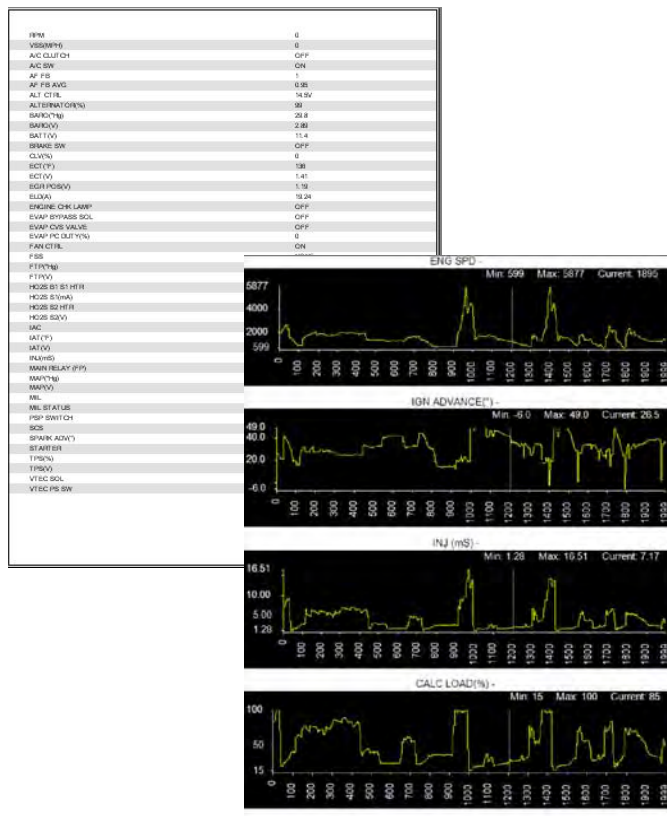

Figure 11-19 Print preview window (text list and graphs examples)

View Menu

The View menu allows you to change how data is displayed on the screen (Figure 11-20).

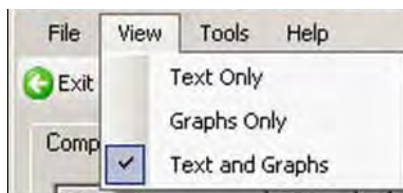

Figure 11-20 Scanner DataViewer View menu

Select from the following menu options:

- **Text Only**—shows all parameters and their values as text only
- **Graphs Only**—shows all parameters as graphs only
- **Text and Graphs**—shows all parameters and their values as text in the left panel of the screen, and shows them as graphs in the right panel of the screen

Tools Menu

The Tools menu opens the Properties dialog box.

The Properties dialog box has two sections (Figure 11-21); Shared Graph Properties and Individual Properties. Shared Graph Properties apply to all graphs and Individual Properties apply to the selected graph only.

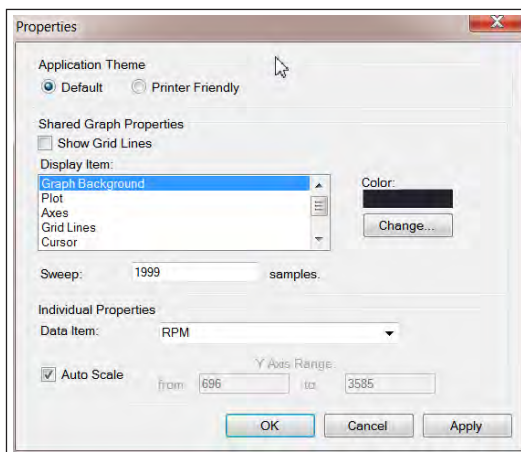

Figure 11-21 Properties dialog box

Properties dialog box selections include:

- **Grid Lines**—when selected, a line displays at each major division of the graphs.
- **Display Item**—use to view the display color of the listed items. Highlight an item and the current color appears in the Color box.
- **Change**—use to change the color of the highlighted item, select to open a color palate.
- **Sweep**—use to adjust the number of data frames that appear on the screen (zoom in or out), highlight and type in the desired number.
- **Reset Colors**—use to restore the default color settings.
- **Data Item**—use this pulldown menu to select individual graphs for modification.
- **Auto Scale**—minimum and maximum (Y axis) values automatically adjust to the signal when the box is checked, uncheck the box if you want to custom set the values.
- **Y Axis Range**—use to type desired minimum (from) and maximum (to) values in the selection boxes. This field is only active when Auto Scale is deselected.
- **OK**—applies the changes and closes the properties dialog box.
- **Cancel**—closes the properties dialog box without making changes.
- **Apply**—applies the changes and leaves the properties dialog box open.



NOTE:

The Properties icon on each graph also opens the Properties dialog box (Figure 11-17).

Help Menu

The Help menu provides Scanner Viewer software version information.

11.6.2 Display Toolbar

The Display toolbar provides the following controls (Figure 11-22).

- **Exit**—closes Scanner DataViewer.
- **Hide PID List**—toggles display between parameter text and graph views.
- **Display Views (1 to 16)**—determines how many graphs display at a time.
- **Scale**—switches the scale values shown to the left of the graph off and on.
- **Sweep**—switches the sweep values shown below the graph off and on.

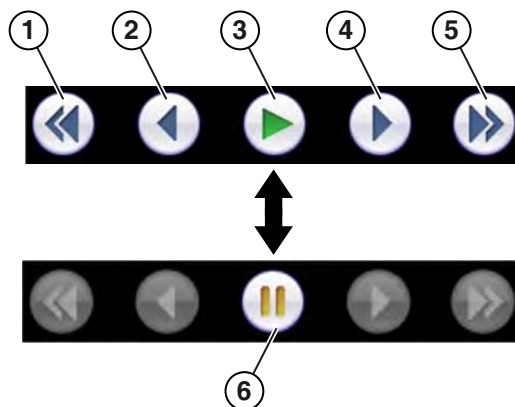

Figure 11-22 Display toolbar

11.6.3 Navigation Tools

Playback Controls

The playback controls allow you to navigate through saved data (Figure 11-23).



- 1— **Skip Back**—Allows backward movement in multiple steps.
- 2— **Step Back**—Allows backward movement in singular steps.
- 3— **Play**—Select to play.
- 4— **Step Forward**—Allows forward movement in singular steps.
- 5— **Skip Forward**—Allows forward movement in multiple steps.
- 6— **Pause**—Select to pause playback.

Figure 11-23 Playback controls

Zoom Controls

The zoom controls allow you to incrementally increase or decrease the screen magnification (Figure 11-24).

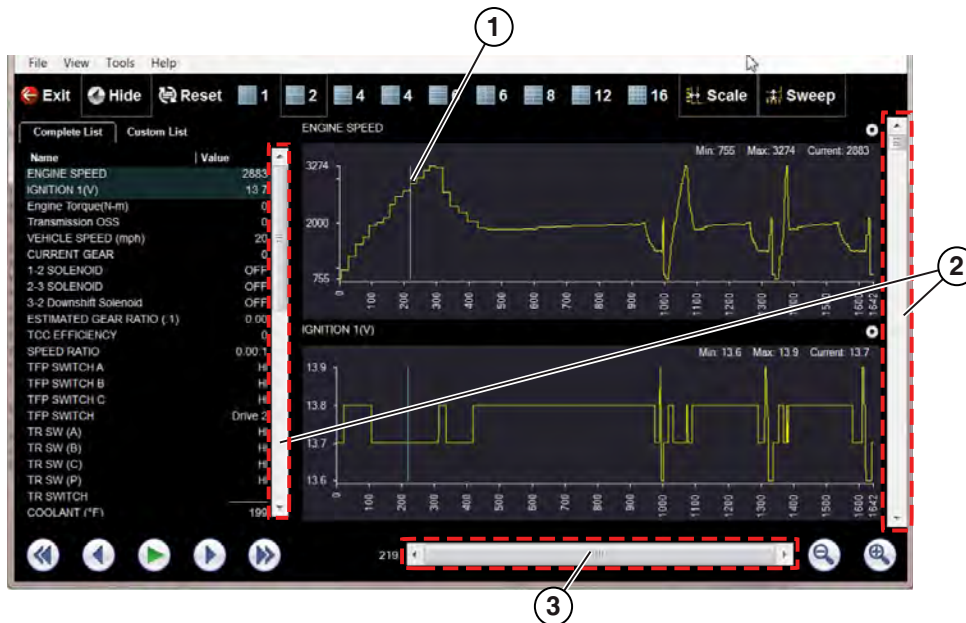

Figure 11-24 Zoom controls

Slider / Scroll Bars and Cursor

Use the slider bar to quickly navigate through the data (Figure 11-25). During playback the number displayed on the left side of the slider bar indicates the current position of the cursor in the data file. The cursor can be repositioned during playback or when paused, by selecting and dragging.

Use the scroll bar (right side) to vertically scroll through the parameter list and graphs.



- 1— Cursor
- 2— Scroll bar
- 3— Slider bar

Figure 11-25

11.6.4 Customizing the Display

The parameter text list (left side) displays parameter names and current values.

The display can be customized by selecting and dragging parameters from the text list or graph display to a different location in the text list or in the graph display (Figure 11-26). The highlighted parameters in the text list indicate which parameters are displayed as graphs.



NOTE:

The parameter text list is sortable by name and value. Select Name or Value at the top of the list to change the sorted view.



Figure 11-26

11.6.5 Customizing the Parameter List

1. The parameter configuration tabs allow you to choose between displaying all available parameters (Complete List), or only those from a (Custom List) (Figure 11-27).



To customize the parameter list:

1. Select the **Custom List** tab (Figure 11-27).
2. Select **Edit List** in the custom window.



1— Edit List

2— Custom List tab

Figure 11-27

- A list of available parameters displays (Figure 11-28).
3. Select the parameters to include in your custom list. Select All and Deselect All controls are also available to assist in the selection process.



Figure 11-28 Creating a custom parameter list

4. Select **Save & Exit** to close the window.
Only the parameters selected in your custom list are displayed.

11.7 Scope Viewer

This section is intended as an introduction of the Scope Viewer, as many features are similar to the Scope module features. The Scope Viewer allows you to print and playback recorded trace signals captured on your diagnostic tool. When a scope file is selected, it opens and displays in the Scope File Viewer.

The Scope Viewer allows you to print and playback recorded trace signals captured on your diagnostic tool. When a scope file is selected, it opens and displays in the Scope File Viewer.

The Scope File Viewer is intended to be used to review scope and meter files originally captured on a diagnostic tool. Some features (control icons) of the Scope File Viewer may not be available “grayed out”. This is normal as those features are only applicable when viewing live data on a diagnostic tool.

The Scope File Viewer screen includes the following sections:

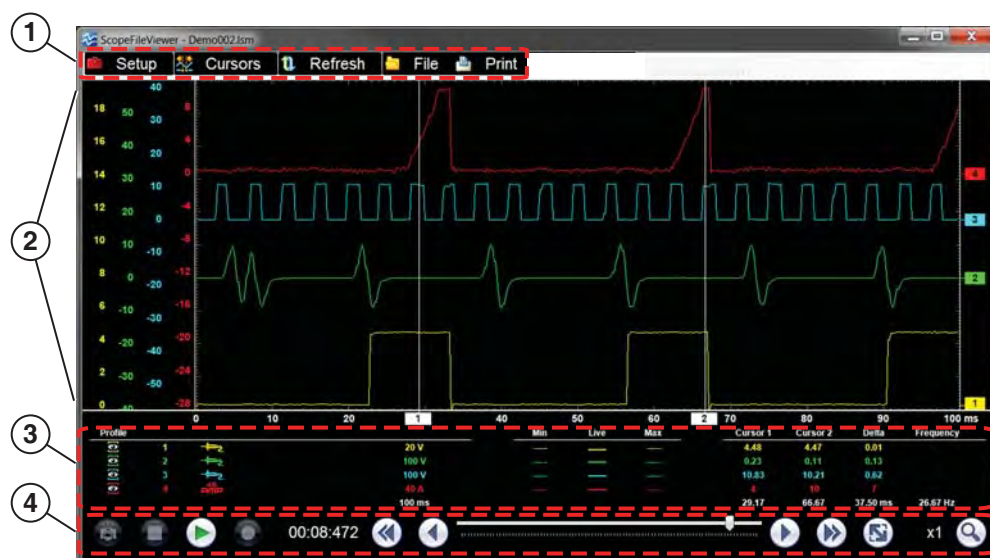

Figure 11-29

- 1— **Toolbar** - contains control icons
- 2— **Main Body** - displays recorded trace results
- 3— **Profile Controls Window** - displays profile control icons and trace display settings
- 4— **Playback Control Toolbar** - contains playback and display controls

11.8 Image Viewer

The Image Viewer allows you to open and view image files and screenshots.

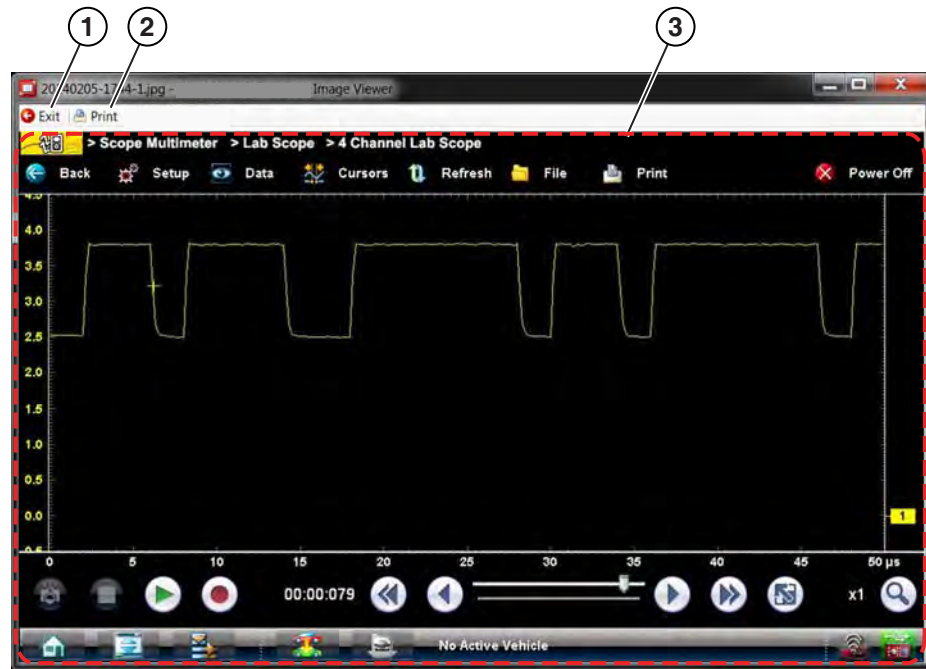

Figure 11-30

- 1— Exit - closes the Image Viewer
- 2— Print - prints the image
- 3— Captured Screen Image









Selecting **Help** from the Home screen opens this manual in a dedicated screen viewer. Navigate through the file either by gesture scrolling on the touch screen, or with the scroll bar along the right edge of the viewing screen. A left-to-right scroll bar appears at the bottom of the screen when magnification is increased.

All listings in the Contents and Index are active links. Select an entry with the stylus to go directly to that point of the document. Additional links within the text, shown in blue-colored type, also take you to the referenced section of the manual.

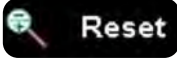
12.1 Using the Help Toolbar

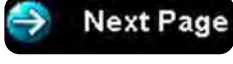
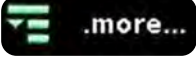
A simple toolbar at the top of the screen is used to adjust screen magnification and to exit Help:

Table 12-1 *Help toolbar icons*

Name	Icon	Description
Back		Closes the help file and returns you to the previously viewed screen.
Zoom +		Incrementally increases the screen magnification.
Zoom –		Incrementally decreases the screen magnification.
Reset		Restores the default screen magnification.
Previous Page		Moves back one page in the document.
Page Counter		Shows the current page over the total number of pages in the document.
Next Page		Moves forward one page in the document.
More		Opens a menu of the additional options (Hide TOC or Show TOC) shown below.
	Hide TOC	
		Closes the contents and search column so the document fills the screen.
	Show TOC	
		Opens the contents and search column if they have been hidden.
Exit		Closes the help file, and any other open modules, and returns you to the Home screen.

Selecting System Settings from the Home screen opens a menu with two options:

- [Paired Devices](#) - Paired Devices allows you to check the status and pair wireless devices to the Diagnostic Tool.
- [Shop Information](#) - Shop Information allows you to create and edit a personalized header that is included on printed documents.
- [Data Backup](#) - Provides two options, backup and restore.

13.1 Paired Devices

The wireless Scan Module makes vehicle data readily available on the Diagnostic Tool while working anywhere on or around the vehicle. Before use, wireless units must be “paired” in order to create a communications network between them. Information about modules paired to the Diagnostic Tool can be found by selecting System Settings from the Home screen.



To check the devices paired to your Diagnostic Tool:

1. Select **System Settings > Paired Devices**.





The paired devices screen opens ([Figure 13-1](#)).

The Paired Devices screen lists all of the devices paired to the Diagnostic Tool, and also indicates whether or not there is active communication occurring.



Figure 13-1 Typical Paired Devices screen

The Hardware Status indicators in the lower-right corner of the Home screen provide a quick reference to wireless device operations. The background color of the status indicator icon represents the condition of the wireless connectivity to that device. Icon status is shown in the table below:

Hardware Icon	Background Color	Condition	Action
Scan Module			
	Red	Not Paired	Pair the Scan Module to the Diagnostic Tool. See "Pairing The Scan Module," on page 55 for instructions.
	Grey	Paired, but Not Communicating	You may have moved out of range. Move the Diagnostic Tool closer to the Scan Module to reestablish communications. If connectivity is not restored, perform the "Recovery Procedure," on page 61 .
	Blue	Paired and Communicating	Hardware status is good and Bluetooth should be functional. Verify that the green Bluetooth LED on the front of the Scan Module is flashing. If there is no connectivity, perform the "Recovery Procedure," on page 61 .
	Green	USB Cable Connected	Indicates the USB cable is connected.
	Gray	USB Cable Not Connected	Indicates the USB cable is not connected or connected but not allowing communication

13.1.1 Pairing the Wireless Scan Module

For detailed information on the use and pairing of the Scan Module, see ["Pairing The Scan Module," on page 55](#).

13.2 Shop Information

This option allows you to add personalized shop information that can be included on printed data files. Selecting opens a form that can be filled in using the virtual keyboard. Select OK when the form is complete and the information is saved.



To add Shop Information:

1. From the Home screen select **System Settings**.
2. From the System Settings menu select **Shop Information**.

The Shop Information dialog box opens (Figure 13-2).

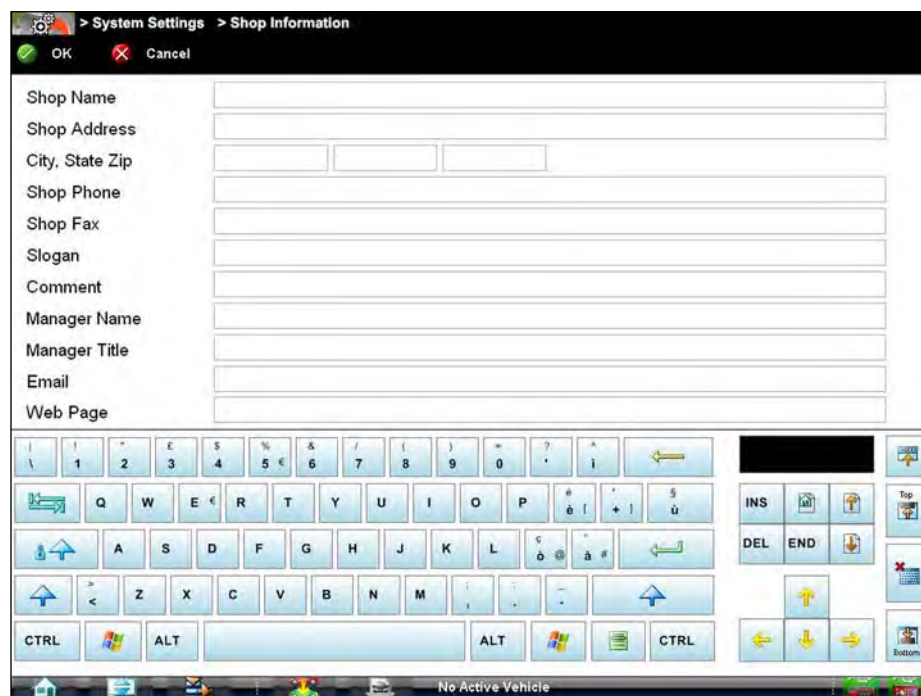

Figure 13-2 Sample Shop Information dialog box

3. Select within any of the information fields and the virtual keyboard opens.
4. Use the virtual keyboard to fill in the Shop Information form.
As an alternative, you can connect a USB keyboard to a USB jack on the Diagnostic Tool and use it to enter information into the form.
5. Close the virtual keyboard and review the information once all the fields have been filled in.
6. Select **OK** from the toolbar to save the Shop Information, or **Cancel** to close the Shop Information dialog box without saving.

The Shop Information screen closes and the screen returns to the System Settings menu.

13.3 Data Backup

Selecting **Data Backup** from the Systems Settings main menu provides two options, backup and restore.

13.3.1 Backup

The Backup option allows you to back up your saved data to a file on the internal hard drive, or to an external drive (e.g. USB flash drive). This option can be used as general maintenance to ensure you have a safe backup of your saved data, or if a issue occurs where a system restore is necessary and you need to retain your saved data. The following types of data are backed up:

- ShopStream Data (saved movie/data files)
- Lab Scope Settings (presets)
- Vehicle History Records and Favorites



To Backup Information:

1. From the Home screen select **System Settings**.
2. From the System Settings main menu select **Data Backup > Backup**.
The destination drive dialog box opens ([Figure 13-3](#)).
3. Select a drive destination.



NOTE:

Drive designations (e.g. E:/, F:/ etc.), are only visible when external drives are connected to the diagnostic tool.

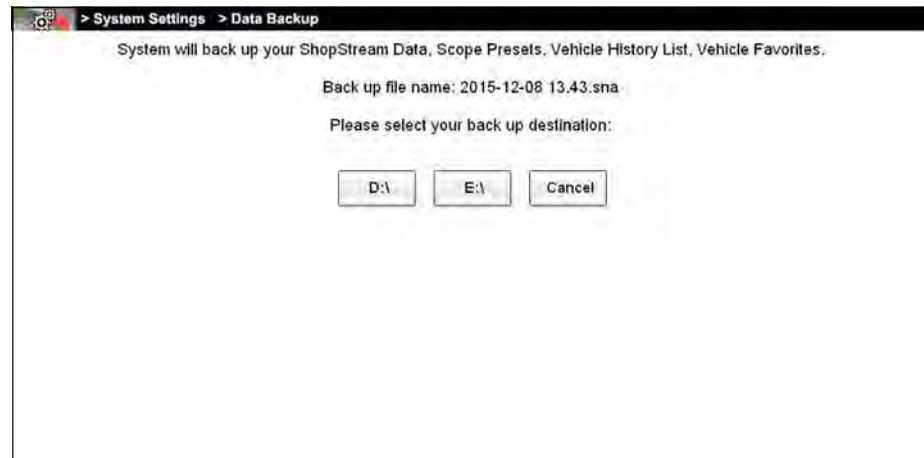

Figure 13-3

A progress screen is displayed as the backup file is saved to the root of the drive selected with a file extension of .sna. Then a confirmation screen is displayed.

4. Select **OK** to complete the procedure.

13.3.2 Restore

The Restore option is used to restore your backed up data, in the event that the data is lost or if a system restore (recovery) has been performed.

This function is only applicable when a backup file has been previously saved (file extension .sna). See "[Backup](#)," on page 148 for additional information.



To perform a data Restore:

1. From the Home screen select **System Settings**.
2. From the System Settings main menu select **Data Backup > Restore**.
The restore file confirmation dialog box opens ([Figure 13-4](#)).
3. Select **Continue**.



Figure 13-4

The Windows restore backup file path dialog box opens.

4. Select the backup file (file extension .sna) from your backup file location.
5. Select **Open** to restore the backup file.

Once the file has been restored a confirmation message is displayed.

6. Select **OK**, then close and restart the Diagnostic application.

Designed to help you improve diagnostic accuracy and reduce repair time, SureTrack is a comprehensive source of expert knowledge for professional technicians, combining diagnostic experience and detailed parts replacement records.

Your access to SureTrack includes:

- A Common Replaced Parts (CRP) graph, showing which parts are most frequently replaced to successfully complete the repair for the selected diagnostic trouble codes (DTC), components or symptom.
- Real Fixes for trouble codes, with complaint, cause and corrective supporting information
- Repair Tips from other professional technicians
- Up-to-the-minute intelligence
- Access to the **SureTrack Community (within ShopKey Pro)**

For more information see Suretrack FAQ's at: <http://mitchell1.com/support/suretrack-faqs/>

14.1 Getting Started Using SureTrack



NOTE:

You must have the current software version installed on the diagnostic tool, and a Wi-Fi Internet connection to use SureTrack.

SureTrack information is accessible in two ways:

- **From within the Scanner Function**

The SureTrack CRP graph, along with Real Fixes and Tips are provided when viewing codes from within the Scanner function, see [Using SureTrack in the Scanner Function](#) on page 151.

- **From the SureTrack Community (within ShopKey Pro)**

The SureTrack Community gives you access to even more information, than what is provided in the Scanner function

The SureTrack Community is accessible in two ways:

- Selecting the **Repair Information** icon from the Home screen. Vehicle identification may be required, enter (identify) any vehicle, or
- Visit shopkeypro.com using a web browser.

For additional information, see [Using the SureTrack Community \(within ShopKey Pro\)](#) on page 154.



NOTE:

The SureTrack icon has been removed from the Home screen as of software version 17.2, and has been disabled on previous versions (e.g. 16.4, 16.2, 15.4, etc).

14.2 Using SureTrack in the Scanner Function

To access SureTrack information from within the Scanner function you must:

- Have a Wi-Fi Internet connection
- Have the current software version installed on the diagnostic tool

If the conditions listed above are met, SureTrack information displays automatically when viewing codes.

SureTrack provides you with specific diagnostic information on the DTC selected. Available DTCs are displayed in a list that includes the DTC, a brief description, and a **Fix It!** icon (Figure 14-1).

Selecting the **Fix It!** icon displays the following SureTrack menu options:

- [Common Replaced Parts Graph](#)
- [Dashboard Feature Information](#)

14.2.1 Common Replaced Parts Graph

The Common Replaced Parts graph (Figure 14-1) shows the percentage of verified fixes (using the parts listed) derived from the total number of repairs by mileage. The example below indicates that based on 41 repairs (intake airflow sensor replacement) involving vehicles with up to 200k miles, approximately 33% of the repairs occurred at 125k miles.



Figure 14-1 Common Replaced Parts Graph

- 1— **Common Replaced Part Graph icon**—toggles Common Replaced Parts graph display on/off.
- 2— **Common Replaced Part Graph**
- 3— **Fix It! icon**—opens Dashboard Feature Information

14.2.2 Dashboard Feature Information

Dashboard Feature Information includes:

- **Detailed DTC Information**
- **Related Tips, Real Fixes and Repair Information**

SureTrack will display detailed information about the current DTC describing code setting conditions, possible symptoms, system operation and possible solutions (Figure 14-2). In addition, other reference links may be provided such as schematics and illustrations.

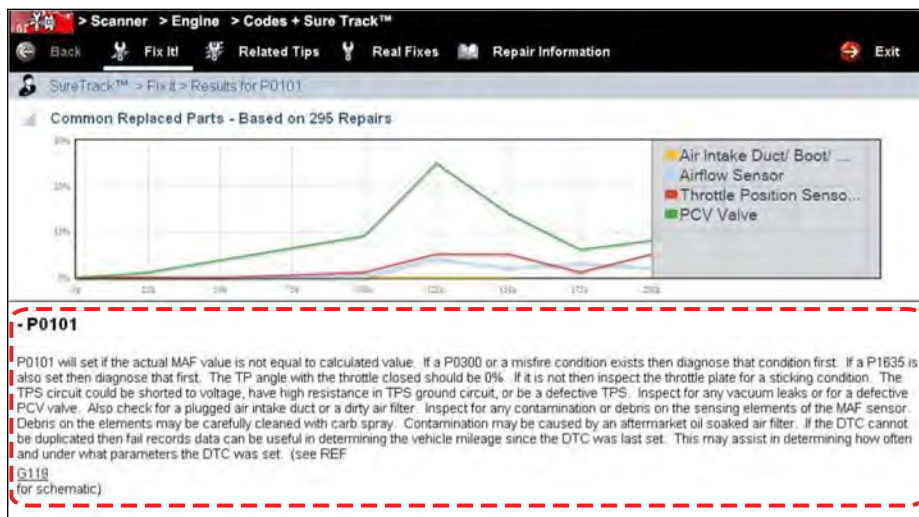

Figure 14-2 "Fix It!" DTC Information

Menu options are also provided for the following:

Related Tips—opens a list of tips that may include information that is related to the current DTC (Figure 14-3).

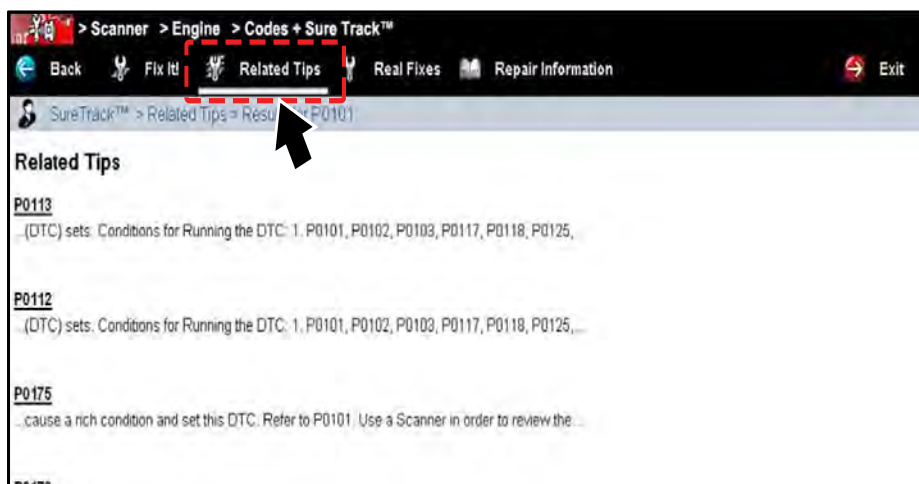

Figure 14-3 Related Tips Screen

Real Fixes—opens a list of tips related to the current DTC that have been gathered from actual shop repair orders and presented in a Complaint, Cause, Correction format (Figure 14-4).

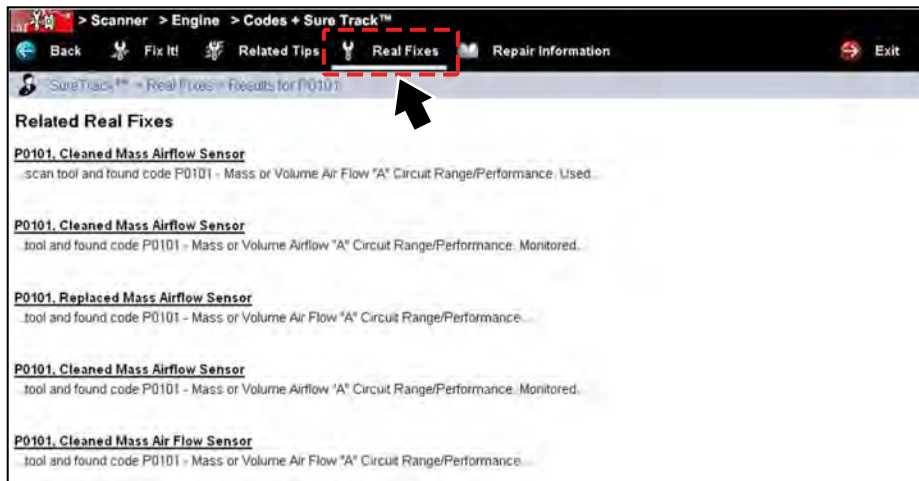

Figure 14-4 Real Fixes Screen

Repair Information—opens the ShopKey Pro website, or login screen, See “Repair Information” on page 111 for additional information.

14.2.3 SureTrack Status Messages

Depending on your software version and connection status the following messages may appear in the SureTrack status bar:

- **SureTrack Content May Be Available!** - indicates SureTrack content may be available, however you are not currently connected to the SureTrack database. This message may be caused by a Wi-Fi connection issue or if you do not have the current software upgrade installed.
- **Loading content from SureTrack** - indicates SureTrack information is being updated from the SureTrack database.
- **A new diagnostic software upgrade is available. See your sales representative for details** - indicates your access to SureTrack will be expiring soon and you should contact your sales representative to purchase the current software upgrade.
- **Your SureTrack access has expired. See your Snap-on representative to renew.** - indicates your access to SureTrack has expired and you should contact your sales representative to purchase the current software upgrade.
- **Verified parts replacement data not available.** - indicates repair and/or diagnostic information is not available at this time for the identified vehicle.
- **Network not available.** - indicates that you have a connection problem with your wireless network.

14.3 Using the SureTrack Community (within ShopKey Pro)

The SureTrack Community includes access to the following features on the ShopKey Pro website:

- **1Search™ Limited** - SureTrack Real Fixes, Related Tips, Common Replaced Parts, and ProView Information
- **SureTrack Community** - A library and forum filled with expert information from fellow professional technicians in the SureTrack community
- **Safety Recalls, OEM Campaigns, and TSB's**

14.3.1 Getting Started

Use Requirements

To use the SureTrack Community you must:

- Have the current software version installed on the diagnostic tool
- Create a SureTrack Account, see [Creating a SureTrack Account](#) on page 154
- Have a current SureTrack Authorization Code, see [Finding your SureTrack Authorization Code](#) on page 156
- Have a Wi-Fi Internet connection
- Have the current Firefox web browser installed on the desktop

Creating a SureTrack Account

In order to use the SureTrack Community, you will need to complete the online registration, and create an account before you can use it.

1. Download and install the current Firefox web browser. Installation and support information are available on the Firefox website: www.mozilla.org
2. Open the Firefox browser and navigate to shopkeypro.com
3. To create an account, follow the illustrated instructions in [Figures 15-5 to 15-7](#).

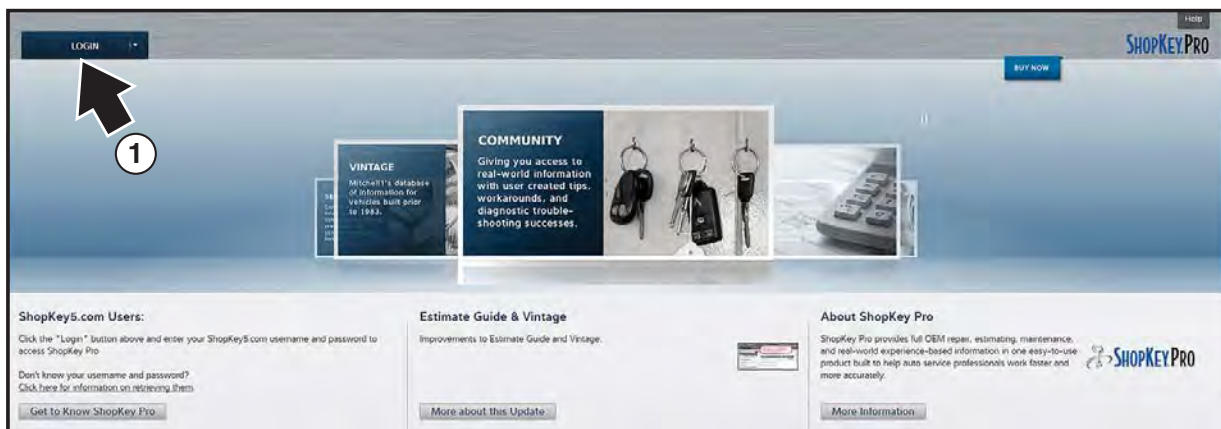

Figure 14-5

Step 1: Login screen with Username and Password fields. A red dashed box highlights the "Create a new Individual Account" link at the bottom. An arrow labeled "2" points to the "Login" button.

Step 2: Registration form with fields for Email, Name (First, Last), Phone, Address (Line 1, 2), City, State, Zip, Online Profile (Username, Password, Retype Password). An arrow labeled "3" points to the "Email Address" field with the text "Enter all required *information." Buttons for "Cancel" and "Create" are at the bottom right.

Step 3: Success message: "Congratulations! Your account has been created. This account can be used to contribute to the community and manage your profile. To link this account to your shop, have your shop add you in Profile Manager." An arrow labeled "4" points to the "Done" button.

Step 4: Login screen with "Remember username & password" checkbox checked. An arrow labeled "5" points to the Username field, and another labeled "6" points to the checkbox. An arrow labeled "7" points to the "Login" button.

Step 5: Security questions screen. An arrow labeled "8" points to the text "Choose 3 security questions." Three question boxes are shown, each with "Choose a question..." and a dropdown arrow. A red dashed box highlights these three boxes. An arrow labeled "9" points to the "Submit" button.

Step 6: Sales receipt from Snap-on. An arrow labeled "10" points to the "SureTrack Authorization Code" line item in the table below. Text below the table reads: "See 'Finding your SureTrack Authorization Code' on the next page. Find the SureTrack Authorization Code on your sales receipt. 12 digit alpha-numeric code (e.g. 123ABCAP4-US)".

Part #	Qty	Description	Line Type	Price	Discount	Total	Tax
EESP0302	1	DO NOT ORDER - VERUS SB SW	Sale	999.00	0.00	999.00	74.93
Serial #:	13-4-33338564552303031303039						
EESPSURTRK0	1	SureTrack Authorization Code	Sale	0.00	0.00	0.00	0.00
Serial #:	123456789-US						

Figure 14-6

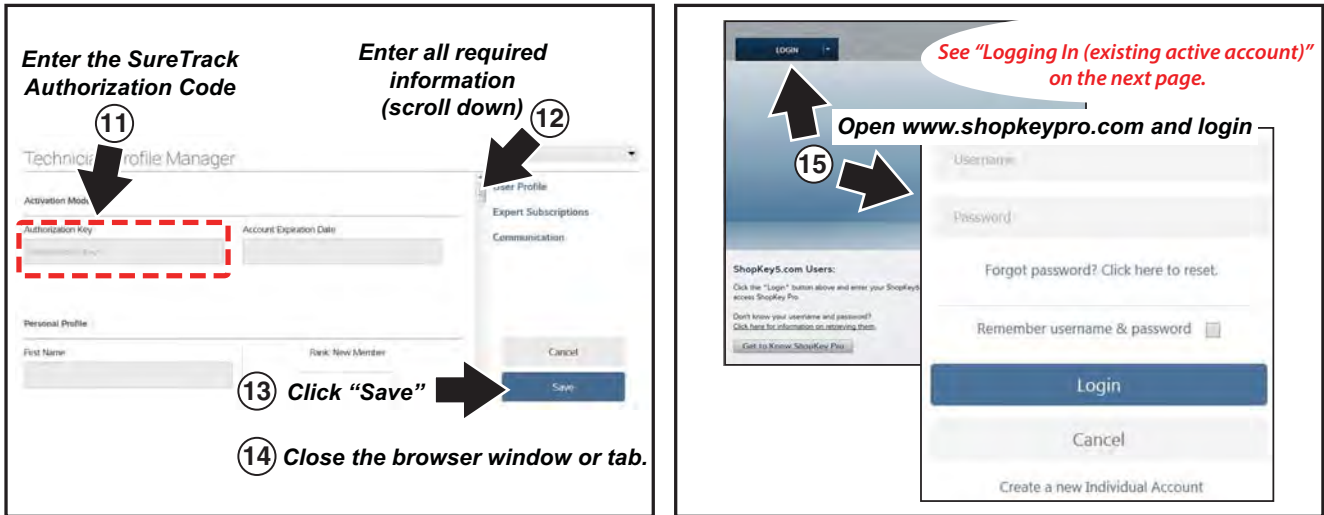

Figure 14-7

Finding your SureTrack Authorization Code

When you purchase a software upgrade, or qualifying platform from your from your Snap-on Representative, you will receive a SureTrack authorization code. The authorization code is printed on your sales receipt. Authorization codes are 12 digit alpha-numeric codes (e.g. 123ABCAP4-US).

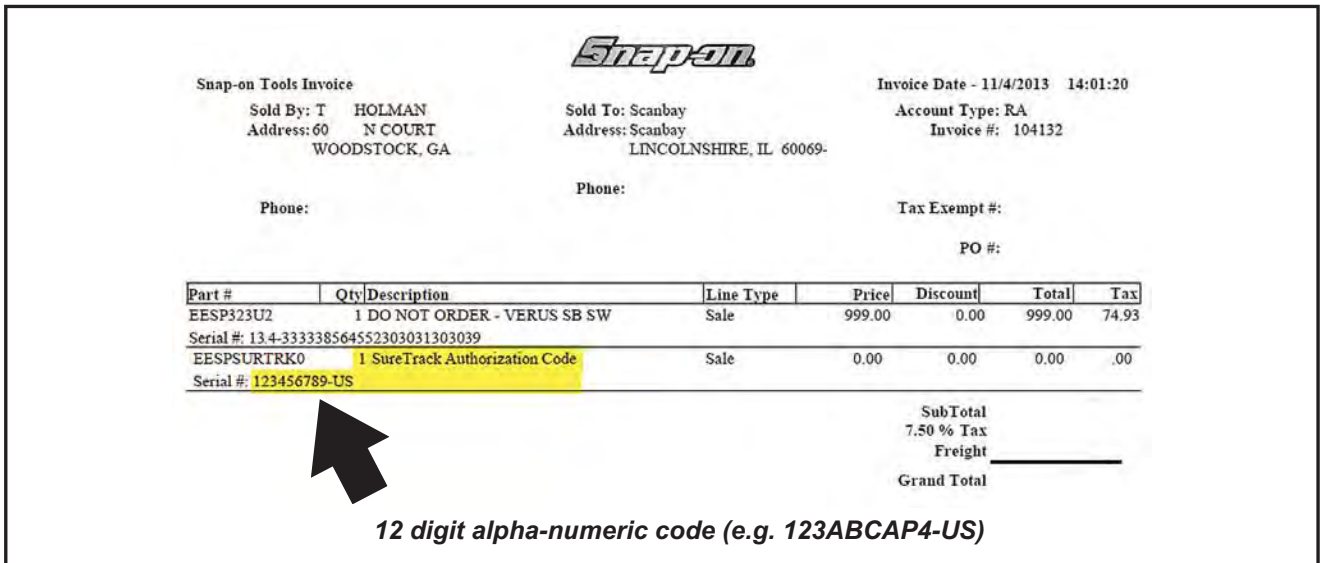

Figure 14-8



NOTE:

If you have purchase a software upgrade, contact your sales representative for your SureTrack authorization code. Software upgrades can be installed using the Software Upgrade Manager program installed on your diagnostic tool.

Each time you purchase an a diagnostics software upgrade you will be provided a new SureTrack authorization code. The authorization code will expire shortly after the release of the next concurrent software upgrade. To log in with a new authorization code, see [Logging In \(existing expired account\)](#) on page 158.

14.3.2 Logging In (existing active account)

Use these instructions after you have created your SureTrack account. See [Creating a SureTrack Account](#) on page 154.



To log in to your active existing account:

1. Navigate to the login page on shopkeypro.com, by:
 - Selecting the **Repair Information** icon from the Home screen. If required, enter vehicle identification information as prompted, any vehicle can be used if a vehicle is not active.Or
 - Visit shopkeypro.com using a web browser.
2. Enter your username and password ([Figure 14-9](#)).
3. *(Optional)* Select the **Remember Me** check box to save your login information ([Figure 14-9](#)).

The image shows a login form with the following elements:

- A text input field labeled "Username" with a red dashed border.
- A text input field labeled "Password" with a red dashed border.
- A link: "Forgot password? Click here to reset."
- A checkbox labeled "Remember username & password" with a red dashed border around the label and checkbox.
- A blue "Login" button.
- A grey "Cancel" button.
- A link: "Create a new Individual Account"

Figure 14-9

14.3.3 Logging In (existing expired account)

Use these instructions, if your existing SureTrack account has expired, and you have purchased a current diagnostic tool software upgrade.



To log in to your existing account using a new authorization code:

1. Navigate to the login page on shopkeypro.com, by:
 - Selecting the **Repair Information** icon from the Home screen. If required, enter vehicle identification information as prompted, any vehicle can be used if a vehicle is not active.
- Or
 - Visit shopkeypro.com using a web browser.
2. Enter your username and password ([Figure 14-9](#)).

If your existing account has expired, you will be automatically redirected to the renewal login screen.

3. On the renewal login screen, enter the NEW SureTrack authorization code found on your software upgrade sales receipt. See [Finding your SureTrack Authorization Code](#) on page 156 for additional information.
4. Follow the screen prompts to complete the login.

14.4 About Upgrade Reminder Messages

As a reminder to keep your software current and retain your access to SureTrack, software upgrade reminder messages will display periodically on the diagnostic tool when new software upgrades are available ([Figure 14-10](#)). To purchase software upgrades, or join the software subscription program, see your Snap-on Representative.

Selecting **OK** will close the message box until the beginning of the next month when it will appear to remind you again. Selecting **Snooze 1 Week** will close the message box for approximately one week and then it will re-appear.

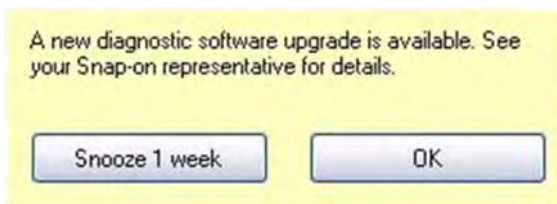

Figure 14-10 Software Upgrade Reminder Message

ShopStream Update Tool (SST)

The ShopStream Update Tool (SST) is a maintenance program that automatically keeps your diagnostic software up-to-date.

The following terms are used in this section and throughout this manual as described below:

- **Software Upgrade** - a new diagnostic software version. Software upgrades include new and enhanced coverage and features.
- **Software Update** - a service release “update” for a existing diagnostic software version

For clarity, throughout this document the term “software update(s)” will be used to collectively describe “software updates, upgrades and SST program updates” using the SST, except where noted.

The ShopStream Update Tool program downloads and installs:

- Diagnostic software upgrades
- Diagnostic software updates
- SST program updates

When connected to the Internet, the SST automatically checks for new software updates. This automatic check also occurs every time the diagnostic tool is turned on. If a software update is available, the SST will download it.

The SST is a low priority program that only downloads software updates when unused bandwidth is available. If other programs are running that communicate over the Wi-Fi network, such as a browser or instant messaging, the download may be temporarily suspended. This allows you to continue normal diagnostic tool operation, without interruptions or loss of performance.

15.1 Basic Operation

The SST program is normally running in the Windows background and available from the Windows system tray. The program can be accessed as follows:

- **SST icon in the Windows system tray** - opens the SST program menu
- **SST program selection from the Windows “All Programs” or “Startup” menus** - starts the SST program and adds the SST icon to the Windows system tray



NOTE:

If necessary, select the **expand**  arrow to see the SST icon in the system tray.

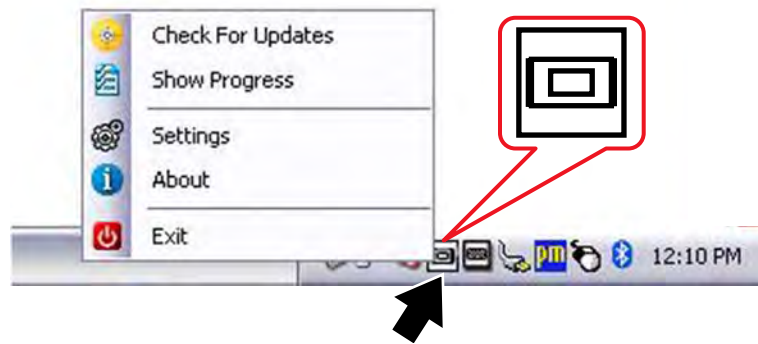

Figure 15-1 SST Icon in system tray

Selecting the SST icon from the system tray provides the following menu choices:

- **Check for Updates** - Allows you to manually check for software updates anytime. See [Manual Software Download](#) on page 161.
- **Show Progress** - allows you to check the status of an active download
- **Settings** - provides SST program options:
 - Turn on/off automatic software installation. **Applies only for SST program updates.** The default setting is “on” (box checked).
 - Set the hourly interval for the SST to check for software updates (choose number 2 to 168). **Applies to SST program updates, and diagnostic tool software upgrades/updates.** The default interval is 4 hours.

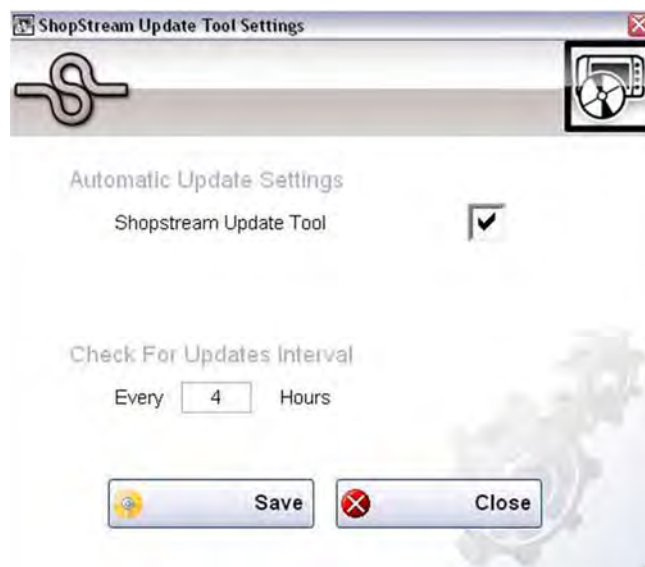

Figure 15-2

- **About** - displays the SST program software version number
- **Exit** - closes the SST program

15.2 Manual Software Download

This section describes the basic procedures for manually downloading software updates and upgrades.

Normally, the SST will automatically detect and download software. If necessary, use the following procedure to manually check for and download software.

NOTE:



It is recommend that you download software upgrades when not actively using the diagnostic tool. Download times will vary as they are dependent on the file size of the upgrade (some upgrades may exceed 3Gb) and your connection speed. It is suggested that you start the download at the end of your day and let it run overnight. It is also suggested that you ensure a download of this size is within the available data allowance of the Internet connection or data plan being used. For software upgrade installation instructions, see [Installing Software Upgrades](#) on page 165.



To manually download software:

1. Select the SST icon in the system tray to open the menu ([Figure 15-3](#)).



Figure 15-3 ShopStream Update Tool icon and menu

2. Select **Check for Updates** from the menu.
A series of message boxes will display as the SST searches for updates (Figure 15-4).



Figure 15-4 Typical - Checking for Updates message

Once the search is complete, one of two results are expected:

- If no updates are found, the message box closes and a “No updates available” message displays. Select the message to close it.
- If updates are found, they will automatically begin to download (Figure 15-5).



Figure 15-5 Typical - Downloading update window



NOTE:

The percentage status bar may not always be displayed while downloading (Figure 15-5).

3. During an active download, two options are available:
 - **Minimize**—closes the message box. The download continues as a background task and the diagnostic tool can be used normally. Select **Show Progress** from the SST icon menu at any time to reopen the message box and check the status of the download.

- **Cancel**—stops and cancels the download and closes the message box. If you select Cancel, and choose to re-start the download again, the download will start from the beginning.
4. Once the download completes, it must be installed. See the applicable instructions for [Installing Software Updates](#) on page 163 or [Installing Software Upgrades](#) on page 165.
- For SST program updates (only) - if you have the Automatic Update setting "on", the update will be installed automatically. See Automatic Update setting in [Basic Operation](#) on page 159 for additional information.
- If you have the Automatic Update setting "off", the SST program must be manually installed. See [Installing Software Updates](#) on page 163.

**NOTE:**

If the Internet connection is interrupted during a download, the download is suspended and a "network unavailable" message displays. The message disappears and the download resumes automatically once the Internet connection is restored.

15.3 Installing Software Updates

When a software update is ready for installation, an installation update message will appear ([Figure 15-6](#)). You can select the message or the SST icon from the system tray at anytime to start the software update installation process.



Figure 15-6 Typical update installation message

**NOTE:**

If applicable, before installing a software update, have your Scan Module and USB cable available. The software update may include Scan Module firmware updates that need to be installed.

**To install a software update:**

1. Select the software update available message ([Figure 15-6](#)), or the SST icon from the system tray.
A software update installation window will display ([Figure 15-7](#)).



Figure 15-7 Typical update installation window

2. Select an installation option to continue:
 - **Install Now**—starts the software update installation. Proceed to step 3.
 - **Install Later**—closes the message. The message will reappear at a later time as a reminder.



NOTE:

If **Install Later** is chosen, you can select the SST icon from the system tray to restart the installation at anytime.

3. Close the **ShopStream Diagnostic Suite** application. The ShopStream Diagnostic Suite should remain closed until the software installation has completed.
4. Follow the on-screen instructions to complete the installation.
5. After the installation is complete, open the **ShopStream Diagnostic Suite** application.
6. If applicable, select **Scanner** from the Home Screen. If a Scan Module firmware update has been received, a "Scan Module firmware update" message will display. Proceed to [Updating Scan Module Firmware](#) on page 63.
 - If the Scanner opens normally and no update message is displayed, proceed to step 7.
7. Turn the diagnostic tool off, then turn it on (re-boot).
8. From the toolbar, select **Menu > HELP > Version Info** to confirm the new version number is installed.

15.4 Installing Software Upgrades

**NOTE:**

It is recommended that you perform software upgrade installations Monday – Friday, during business hours to ensure customer care representatives are available for support. The installation will take approximately 30 minutes. If the installation is interrupted, Contact Snap-on Diagnostics Customer Care for assistance. See the Snap-on contact information at the front of this manual.

**NOTE:**

If applicable, before installing a software upgrade, have your Scan Module and USB cable available. The software upgrade may include firmware updates that need to be installed to the Scan Module.

**To install a software upgrade:**

1. Select the software upgrade available message (Figure 15-8), or the SST icon from the system tray.



Figure 15-8 Typical upgrade installation message

An upgrade installation window will display (Figure 15-9).

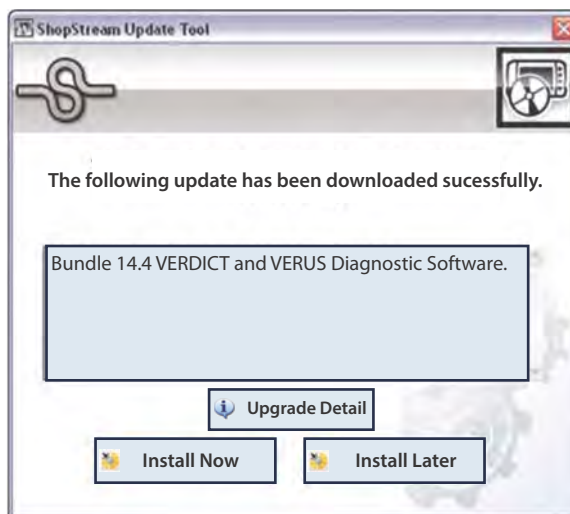

Figure 15-9 Typical upgrade installation window

2. Select an installation option to continue:
 - **Upgrade Detail**—opens a PDF file describing the details of the software upgrade, including any accessories that may be required.
 - **Install Now**—starts the software upgrade installation. Proceed to step 3.
 - **Install Later**—closes the upgrade message. The upgrade available message reappears at a later time as a reminder.

**NOTE:**

If **Install Later** is chosen, you can select the SST icon from the system tray to restart the installation at anytime.

3. Close the **ShopStream Diagnostic Suite** application. The ShopStream Diagnostic Suite should remain closed until the software installation has completed.
4. Follow the on-screen instructions to complete the installation.
5. After the installation is complete, open the **ShopStream Diagnostic Suite** application.
6. If applicable, select **Scanner** from the Home Screen, if a Scan Module firmware update has been received, a “Scan Module firmware update” message will display, proceed to [Updating Scan Module Firmware](#) on page 63
 - If the Scanner opens normally and no update message is displayed, proceed to step 7.
7. Turn the diagnostic tool off, then turn it on (re-boot).
8. From the toolbar, select **Menu > HELP > Version Info** to confirm the new version number is installed.
9. To activate your SureTrack access that comes with your new software upgrade, see [ShopStream Update Tool \(SST\)](#) on page 159.

This section covers how to care for your diagnostic tool.

16.1 Cleaning the Touch Screen

The touch screen can be cleaned with a soft cloth and alcohol or a mild window cleaner.

IMPORTANT:

Do not use any abrasive cleansers or automotive chemicals on the touch screen.

16.2 Calibrating the Touch Screen

The sensitivity and accuracy of the touch screen should be calibrated before you begin using your diagnostic tool. Adjustments can be made to the touch screen calibration to maintain your personal settings. The touch screen can also be set to recognize the stylus being held in place for five seconds as a right-click of a mouse. Both procedures are explained below.

**To calibrate the touch screen:**

1. From the Windows toolbar select **Start > All Programs > Hampshire TSHARC Control Panel** to open the touch screen dialog box (Figure 16-1).

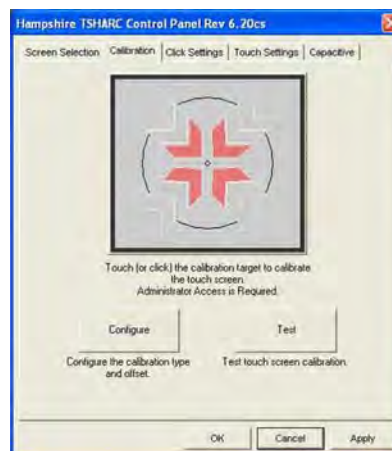

Figure 16-1 Sample Hampshire TSHARC Control Panel window

2. Select the **Calibration** tab.
3. Select **Configure** to open the Calibration Options dialog box.
4. Check **20%** in the Offset field on the right-hand side of the dialog box, **scroll** down and select **20 Point Calibration** on the left-hand side of the screen.

5. Select **OK** to close the Calibration Options dialog box.
6. Select the **Calibration Target** to begin the calibration process.
7. As targets appear on the screen, select the center of the target with the tip of the stylus. Hold the stylus on the target until the release instruction appears.
8. Select **Accept** to save the settings after selecting all of the targets.
9. Select **Apply** to implement the new settings.
10. To make additional adjustments, select other tabs and follow the screen instructions.
11. Select **OK** to close the Control Panel dialog box.

IMPORTANT:

If the touch screen is severely out of calibration use a USB mouse, rather than the stylus, to perform the calibration.

**To set the touch screen for a right mouse click:**

1. From the Windows toolbar select **Start > All Programs > Hampshire TSHARC Control Panel** to open the touch screen dialog box.
2. Select the **Click Settings** tab.
3. Select the **Enable Right Click** check box.
4. Set both the **Right Click Area** and **Right Click Delay** sliders to the middle of the bars.
5. Select **Apply** to implement the new settings.
6. Select **OK** to close the Control Panel dialog box.

16.3 Cleaning and Inspecting the Diagnostic Tool

When using the diagnostic tool, make sure to do the following:

- Check the housing, wiring, and connectors for dirt and damage before and after each use.
- Inspect the fan filter. Replace the filter if it is torn, severely dirty, or otherwise damaged.
- At the end of each working day, clean the housing, wiring, and connectors with a clean damp cloth.

IMPORTANT:

Do not use any abrasive cleansers or automotive chemicals on the diagnostic tool.

16.4 Fan Filter Service

The fan filter should be periodically replaced to ensure an unrestricted source of cooling air to the diagnostic tool. Replacement intervals vary depending upon tool use and environment, replace as needed.

**To replace the fan filter:**

1. Clean off any dirt from the area around the filter.
2. Remove the old filter.
3. Install the new filter.

16.5 Battery Pack Service

Follow all safety guidelines when handling the battery pack.

WARNING



Risk of electric shock.

- **Prior to recycling batteries, protect exposed terminals with heavy insulating tape to prevent shorting.**
- **Disconnect all test leads and turn diagnostic tools off before removing end grips.**
- **Do not attempt to disassemble the battery or remove any component projecting from or protecting the battery terminals.**
- **Do not expose the diagnostic tool or battery pack to rain, snow, or wet conditions.**
- **Do not short circuit the battery pack terminals.**

Electric shock can cause injury.

WARNING



Risk of explosion.

- **The Lithium battery is factory replaceable only, incorrect replacement or tampering with the battery pack may cause an explosion.**

Explosion can cause death or serious injury.

16.5.1 Battery Pack Safety Guidelines

IMPORTANT:

The battery pack contains no user serviceable components. Tampering with the battery pack terminals or housing will void the product warranty.

Keep the following in mind when using and handling the battery pack:

- Do not short circuit battery pack terminals.
- Do not immerse the diagnostic tool or battery pack in water, or allow water to enter the diagnostic tool or battery pack.
- Do not crush, disassemble, or tamper with the battery pack.
- Do not heat the battery pack to over 100°C (212°F), or dispose of it in a fire.
- Do not expose the battery pack to excessive physical shock or vibration.
- Keep the battery pack out of reach of children.
- Do not use a battery pack that appears to have suffered abuse or damage.
- Charge the battery pack in the appropriate charger only.
- Do not use a battery charger that has been modified or damaged.
- Use the battery pack for the specified product only.
- Store the battery pack in a cool, dry, well ventilated area.



NOTE:

The battery pack should be used within a short period of time (about 30 days) after charging to prevent loss of capacity due to self-discharging.

If long-term storage of the battery pack is necessary, it should be stored in a cool, dry, well ventilated place with a 30 to 75 percent state of charge to prevent loss of characteristics.

To prolong the life of your battery, power off the diagnostic tool when it is not in use. The diagnostic tool has a built in charger that recharges the battery on demand whenever it is connected to a power source. A Smart Battery Charger, which prolongs battery life and improves performance, is available as an option.

The optional Smart Battery Charger ensures maximum performance by cycling the battery to a complete discharge state, then slowly drawing it up to a full charge. This over-night charging cycle is highly recommended for units that are subjected to heavy usage.

16.5.2 Replacing the Battery Pack

If the battery pack no longer holds a charge, contact your sales representative to order a new one.

IMPORTANT:

Replace the battery pack with original Snap-on replacement parts only.

**To replace the battery pack:**

1. Remove the right-side handgrip from the diagnostic tool.
2. Depress the lock tab on the back side of the battery pack.
3. Slide the battery pack clear of the diagnostic tool.
4. Fit the new battery pack into the slot.
5. Install the handgrip.

16.5.3 Disposing of the Battery Pack

Always dispose of a lithium-ion battery pack according to local regulations, which vary for different countries and regions. The battery pack, while non-hazardous waste, does contain recyclable materials. If shipping is required, ship the battery pack to a recycling facility in accordance with local, national, and international regulations.

- **United States of America**—Rechargeable Battery Recycling Corporation (RBRC) at <http://www.rbrc.org> or <http://www.call2recycle.org>, or call 1(800) 822-8837 (USA)
- **Canada**—Rechargeable Battery Recycling Corporation (RBRC) at www.call2recycle.ca

Products bearing the WEEE logo (Figure 16-2) are subject to European Union regulations.



Figure 16-2 *sample WEEE logo*

**NOTE:**

Always dispose of materials according to local regulations.

Contact your sales representative for details.

16.5.4 Battery Pack Calibration

The battery pack contains a micro controller that monitors the battery pack characteristics and maintains an internal “fuel gauge”. The internal fuel gauge may lose some accuracy after many cycles of partial discharge and charge. Should this happen, the fuel gauge can be calibrated with the following procedure:



To calibrate the battery pack fuel gauge:

1. Fully charge the battery pack.
2. Fully discharge the battery pack at a steady rate.

IMPORTANT:

The battery must be completely discharged! Operate the diagnostic tool until it shuts down by itself due to a lack of power. Continue operating the tool when the “low battery” warning displays, do not begin charging until after the tool has automatically shut down.

3. Fully charge the battery pack.



NOTE:

It is not recommended to perform the calibration procedure more than once within 30 days.

The optional Smart Battery Charger automatically cycles the battery pack to calibrate it.

16.6 System Restore

The diagnostic tool contains Snap-on System Restore software that returns the tool to original factory condition following a catastrophic failure. Use the procedure below to restore the system if your diagnostic tool does not start the Windows operating system, or if the hard disk drive or other system files have become corrupted.

IMPORTANT:

All data on the hard disk drive C is erased during a system restore. If at all possible, make a back up copy of any personal or saved data before proceeding.

It is highly recommended that the diagnostic tool be connected to an AC power source when performing a system recovery. If AC power is not available, make sure the internal battery pack is fully charged.



To restore the system software:

1. With the diagnostic tool turned off, connect an external keyboard to the USB jack on top of the diagnostic tool.
2. Select and hold the **Left ALT** key on the keyboard, then press the **Power** button.
A dialog box warning that all data on drive C will be deleted and replaced with original factory data displays.
3. Select **OK** to proceed with the restore, or **Cancel** to abort.

The system restore begins and the time remaining until completion displays if OK is selected. The operation typically takes from 10 to 20 minutes.

4. When the “finished successfully” message displays, select **OK** to reboot the system.
The Windows system reseat program automatically runs on start up and a dialog box displays. Once the reseat completes, the dialog box closes, Windows starts, and the diagnostic tool is ready for use.

If you receive an error message while starting the software, the license key may need to be updated or replaced. Contact your sales representative or Customer Care.

**NOTE:**

After using the Snap-on System Restore software, the diagnostic tool is restored to original factory condition. In addition, if you have purchased and installed any of the “Bundle” updates, the most current Snap-on Bundle update will also be re-installed. However, any additional software that you installed will need to be reloaded onto the system after a System Restore. Contact your sales representative or Customer Care for additional information.

16.7 Scan Module

When using the wireless Scan Module, make sure to do the following:

- Check the housing, wiring, and connectors for dirt and damage before and after each use.
- At the end of each working day, clean the housing, wiring, and connectors with a clean damp cloth.

IMPORTANT:

Do not use any abrasive cleansers or automotive chemicals on the Scan Module.

16.7.1 Replacing the Protective Handgrip

The soft protective handgrip that covers the outer edges of the Scan Module is easily replaced should it become worn or damaged. Contact your sales representative for replacement parts.

**To replace the protective handgrip:**

1. Disconnect the data cable, and any other cables, if attached to the Scan Module.
2. From the bottom of the Scan Module, gently lift up and out on one side of the handgrip to free it from Scan Module housing.
3. Repeat step 2 to loosen the other side of the handgrip.
4. Lift the handgrip off of the Scan Module housing.

**NOTE:**

The handgrip tapers toward the front of the Scan Module housing. Make sure the replacement handgrip is correctly oriented before attempting to install it.

5. Fit the new handgrip over the top, data cable end, of the Scan Module housing.
6. With your fingers, work the new handgrip onto the Scan Module housing from top to bottom. Make sure the tabs on the handgrip fit into the grooves on the housing.