

ETHOS[®] Edge

User Manual



Legal Information

Trademarks

Snap-on is a trademark, registered in the United States and other countries, of Snap-on Incorporated. This publication contains many Snap-on Incorporated trademarks, including but not limited to Snap-on, SureTrack and ShopStream. All other marks are trademarks or registered trademarks of their respective holders.

Copyright Information

© 2020 Snap-on Incorporated. All rights reserved.

Disclaimer of Warranties and Limitation of Liabilities

All pictures and illustrations shown are for reference purposes only. All information, specifications and illustrations in this manual are based on the latest information available at the time of printing and are subject to change without notice. While the authors have taken due care in the preparation of this manual, nothing contained herein:

- Modifies or alters in any way the standard terms and conditions of the purchase, lease, or rental agreement under the terms of which the equipment to which this manual relates was acquired.
- Increases in any way the liability to the customer or to third parties.

Snap-on[®] reserves the right to make changes at any time without notice.

IMPORTANT:

Before operating or maintaining this unit, please read this manual carefully paying extra attention to the safety warnings and precautions.

Software License Information

Use of Software is governed by the terms and conditions of the End User License Agreement. The diagnostic tool should not be initially operated until the End User License Agreement is read. Use of the device acknowledges your acceptance of the End User License Agreement. The Snap-on Incorporated Software End User License Agreement may be provided with the diagnostic tool, and is available at: <https://eula.snapon.com/diagnostics>.

Patent Information

For a listing of Snap-on products that are protected by patents in the United States and elsewhere, visit: <https://patents.snapon.com>

User Manual Information

This manual includes information and images applicable with diagnostic software version 18.4 and later. Some information within this manual may not be applicable with other diagnostic software versions.

The information in this manual is periodically revised to ensure the latest information is included. The current version of this manual and other technical documentation is available online from Snap-on Diagnostics.

FCC Compliance Statement

This equipment has been tested and found to comply with the limits for a Class B digital device, pursuant to part 15 of the FCC rules. These limits are designed to provide reasonable protection against harmful interference in a residential installation. This equipment generates, uses and can radiate radio frequency energy and, if not installed and used in accordance with the instructions, may cause harmful interference to radio communications. However, there is no guarantee that interference will not occur in a particular installation. If this equipment does cause harmful interference to radio or television reception, which can be determined by turning the equipment off and on, the user is encouraged to try to correct the interference by one or more of the following measures:

- Reorient or relocate the receiving antenna.
- Increase the separation between the equipment and receiver.
- Connect the equipment into an outlet on a circuit different from that to which the receiver is connected.
- Consult the dealer or an experienced radio/TV technician for help.

CAUTION

You are cautioned that changes or modifications not expressly approved by the party responsible for compliance could void your authority to operate the equipment.

FCC RF Radiation Exposure Statement

1. This transmitter must not be co-located or operating in conjunction with any other antenna or transmitter.
2. This equipment complies with FCC RF radiation exposure limits set forth for an uncontrolled environment. This device was tested for typical lap held operations with the device contacted directly to the human body to the back side of the Display Unit. To maintain compliance with FCC RF exposure compliance requirements, avoid direct contact to the transmitting antenna during transmitting.
3. According to FCC 15.407(e), the device is intended to operate in the frequency band of 5.15GHz to 5.25GHz under all conditions of normal operation. Normal operation of this device is restricted to indoor use only to reduce any potential for harmful interference to co-channel MSS operations.

Product Support Information

Phone / E-mail - Technical Assistance

1-800-424-7226 / diagnostics_support@snapon.com

or use our online contact form

- <https://www1.snapon.com/diagnostics/us/Contact>

Website Links:

Snap-on Diagnostics and Information

- <http://diagnostics.snapon.com>

Manuals / Technical Documentation - This manual is periodically revised to ensure the latest information is included. Download the latest version of this manual and other related technical documentation at:

- <http://diagnostics.snapon.com/usermanuals>

For technical assistance in all other markets, contact your selling agent.

Product Training Videos

Diagnostic tool specific training videos are available on our website. Follow along and learn the basics of diagnostic tool operation with our free training videos.

Videos are product specific and are available at:

<http://diagnostics.snapon.com> - Click on the "Training & Support" tab, select the applicable diagnostic tool, then select "See Training".



NOTE:

Sample titles are listed below. Not all titles may be available for all diagnostic tools, and are subject to change.

Snap-on® Training Solutions® - Training Videos (examples)	
Introduction and Navigation	Global OBD-II
Scanner Codes	Digital Multimeter
Scanner Data in PID View	Graphing Multimeter & Lab Scope
Scanner Data in Graphing View	Guided Component Tests
Fast-Track® Troubleshooter	Vehicle Specs & Resets
Functional Tests	SureTrack® & Wi-Fi

Diagnostic Quick Tips - Video Series

Snap-on Diagnostic Quick Tips videos are available at no charge on our website and on our YouTube channel. These videos are developed from real repair case studies to help professional technicians use diagnostic tools to solve specific vehicle problems (e.g. performing a Ford Relative Injector Flow Test).

Additional videos are also available showing specific diagnostic tool features (e.g. ShopStream Connect - Software Updates).



Figure 1-1

Videos are available at:

<http://diagnostics.snapon.com> - Click on the “Training & Support” tab, select the applicable diagnostic tool, then select “See Quick Tips”

<https://www.youtube.com/user/snaponscanner/videos> - Use the search function to find a title, or enter “Diagnostic Quick Tips” in the search field to see a list of all applicable titles.



NOTE:

URL links (above) and titles listed (below) are subject to change and may not be available in all markets.

A sample list of titles are listed below, other titles may be available.

Some videos may not be applicable for use with all diagnostic tools.

Snap-on® Training Solutions® - Diagnostic Quick Tips Videos (examples)	
Air/Fuel Ratio Sensor Test	Fuel Injector Voltage and Current Tests (Scope)
Alternator Ripple Test (Scope)	Fuel Pump Current Ramp Test (Scope)
BMW® Rain Sensor Calibration	Harley-Davidson® ABS Brake Bleed
CAN Bus Diagnostics (Scope)	Harley-Davidson® Functional Tests
Chevrolet® Volt Coolant Pump Bleed	Harley-Davidson® Key Fob Programming

Snap-on® Training Solutions® - Diagnostic Quick Tips Videos (examples)	
Chrysler HVAC Test	Hyundai Blind Spot Detection System Calibration
Chrysler VVT System Cleaning	Hyundai Occupant Detection System Reset
Chrysler Wheel & Tire Calibrations	Ignition Coil Current and Voltage Comparison
COP Ignition Test	Ignition Coil Current Ramp Test
Dual Screen Diagnostics: Scanner vs. Scope	Ignition Coil Primary Voltage Test
Electronic Throttle Control System Diagnostics	Ignition System Diagnostics Using the SIA2000 (Scope)
FIAT® 500 Proxi Alignment	MINI Battery Relearn
FIAT® 500 Throttle Body Relearn	Multi Channel Cam / Crank Correlation
Flex Ray Bus Diagnostics	OBD-II Mode 10 Permanent Codes
Ford Battery Monitor System	Oil Specs & Service Light Resets
Ford Coil Current RFI Test (Scope)	PID Trigger Functions (Scanner)
Ford Flash Reprogramming	Piezo Injectors Signature Test
Ford Misfire Monitor Neutral Profile Correction (Scanner)	Relative Compression Test (Scope)
Ford PATS Key Programming	ShopStream Connect - Data Manipulation
Ford Relative Compression Test	ShopStream Connect - Software Updates
Ford Relative Injector Flow Test	Speed Up Your Diagnostics (Scanner)
Ford TPMS Reprogramming	The Power of Troubleshooter Tips (Scanner)
Ford® 6.7L Transmission Solenoid Characterization	Top Level Menus: Built In Scope Training
Ford® Diesel Injector Coding	Toyota EVAP Test
VW / Audi Flexible Service Reset (Scanner)	Toyota Multiple Freeze Frame (Scanner)
	Toyota Transmission Compensation Coding

Contents

Safety Information	4
Chapter 2: Using This Manual	6
Content	6
Conventions	6
Terminology	6
Symbols	6
Bold Text	7
Notes and Important Messages	7
Hyperlinks	7
Procedures	7
Chapter 3: Introduction	8
Control Buttons	9
Data and Power Connections	10
Battery Pack Cover and Stand	10
Power Sources	11
Vehicle Power	11
Internal Battery Pack	11
AC Power Supply	11
Technical Specifications	12
Chapter 4: Basic Operation and Navigation	13
Turning On/Off and Emergency Shutdown	13
Turning On	13
Turning Off	13
Emergency Shutdown	14
Basic Navigation	14
Home Screen Layout	14
Title Bar	15
Home Screen Icons	16
Common Toolbar Control Icons	17
Scroll Bar	17
Screen Messages	18
System Messages	18
Communication Messages	18
Data Cable Connection (Automotive)	19
Chapter 5: Quick Training Guide	20
Scanner Demonstration	20
OBD-II/EODB Demonstration	24
Chapter 6: Scanner - Automotive	27
Scanner Demonstration Program	27
Screen Layout and Toolbar Icons	28

Screen Layout	28
Scanner Control Icons	29
Scanner Operation	30
Vehicle Identification	30
Code Scan	34
System Main Menu Options	37
Codes Menu	37
Saving Scanner / OBD-II/EOBD Data Files	45
Functional Tests	46
Generic Functions	47
Exiting Scanner	47
Chapter 7: Scanner - Motorcycle	48
Basic Operation	48
Basic Scanner Operation (Quick Start)	48
Data Cable Connection	49
Vehicle Identification / System Selection	50
Chapter 8: OBD-II/EOBD	53
Basic Operations	53
Screen Layout and Toolbar Controls	53
Connecting the Data Cable	53
Saving and Reviewing Data Files	53
OBD-II/EOBD Menu	54
OBD Health Check	54
OBD Direct	57
Chapter 9: Quick Lookups	64
Oil Specs and Resets	64
Operation	65
Reset Procedure	69
Tire and Wheel Service	72
Operation	72
Chapter 10: Previous Vehicles and Data	79
Previous Vehicles and Data Menu	79
Vehicle History	79
View Saved Data	80
Viewing Codes and Code Scan Results	81
Delete Saved Data	82
Chapter 11: Tools	83
Tools Menu	83
Connect-to-PC	84
Configure Shortcut Button	85
System Information	85
Settings	86
Chapter 12: Maintenance	94
Cleaning and Inspecting the Diagnostic Tool	94
Cleaning the Touch Screen	94

Battery Pack Service	94
Battery Pack Safety Guidelines	95
Replacing the Battery Pack.....	96
Disposing of the Battery Pack.....	97
Chapter 13: Wi-Fi Connection / Troubleshooting	98
Checking if Wi-Fi is On/Off	98
Checking if Wi-Fi is Connected	98
Wi-Fi Icons (Setup).....	99
Turning Wi-Fi On and Connecting to a Network.....	99
Add Network Advanced (Connecting to a hidden network).....	101
Wi-Fi Testing	101
Wi-Fi Troubleshooting and Status Messages.....	103
Informative Messages	105
Chapter 14: ShopStream Connect	106
Using SSC (Connecting to your PC)	106
SSC Main Screen	107
Scanner DataViewer.....	108
Image Viewer.....	109
Printing the Code Scan Report.....	110
Software Upgrades and Updates	112
End User License Agreement	113
Chapter 15: SureTrack Community	114
SureTrack - Online Community	114
Main Topic Links	114
Quick Reference	114
Finding your SureTrack Authorization Code	115
Creating a SureTrack Account.....	116
Logging In (active account).....	120
Logging In with New Authorization Code (active account)	121
Logging In with New Authorization Code (expired account)	122
SureTrack Features	124
SureTrack Screens	125

Safety Information

READ ALL INSTRUCTIONS

For your own safety, the safety of others, and to prevent damage to the product and vehicles upon which it is used, it is important that all instructions and safety messages in this manual and the accompanying *Important Safety Instructions* manual be read and understood by all persons operating, or coming into contact with the product, before operating. We suggest you store a copy of each manual near the product in sight of the operator.

For your safety, read all instructions. Use your diagnostic tools only as described in the tool user's manual. Use only manufacturer recommended parts and accessories with your diagnostic tools.

This product is intended for use by properly trained and skilled professional automotive technicians. The safety messages presented throughout this manual and the accompanying *Important Safety Instructions* manual are reminders to the operator to exercise extreme care when using this product.

There are many variations in procedures, techniques, tools, and parts for servicing vehicles, as well as in the skill of the individual doing the work. Because of the vast number of test applications and variations in the products that can be tested with this instrument, we cannot possibly anticipate or provide advice or safety messages to cover every situation. It is the responsibility of the automotive technician to be knowledgeable of the system being tested. It is essential to use proper service methods and test procedures. It is important to perform tests in an appropriate and acceptable manner that does not endanger your safety, the safety of others in the work area, the equipment being used, or the vehicle being tested.

It is assumed that the operator has a thorough understanding of vehicle systems before using this product. Understanding of these system principles and operating theories is necessary for competent, safe and accurate use of this instrument.

Before using the equipment, always refer to and follow the safety messages and applicable test procedures provided by the manufacturer of the vehicle or equipment being tested. Use the product only as described in its user manual. Use only manufacturer recommended parts and accessories with your product.

Read, understand and follow all safety messages and instructions in this manual, the accompanying *Important Safety Instructions* manual, and on the test equipment.

Environmental Conditions:

- This product is intended for indoor use only
- This product is rated for Pollution Degree 2 (normal conditions)

Safety Signal Words

All safety messages contain a safety signal word that indicates the level of the hazard. An icon, when present, gives a graphical description of the hazard. Safety Signal words are.

DANGER

Indicates an imminently hazardous situation which, if not avoided, will result in death or serious injury to the operator or to bystanders.

WARNING

Indicates a potentially hazardous situation which, if not avoided, could result in death or serious injury to the operator or to bystanders.

CAUTION

Indicates a potentially hazardous situation which, if not avoided, may result in moderate or minor injury to the operator or to bystanders.

Safety Message Conventions

Safety messages are provided to help prevent personal injury and equipment damage. Safety messages communicate the hazard, hazard avoidance and possible consequences using three different type styles:

- Normal type states the hazard.
- **Bold type states how to avoid the hazard.**
- *Italic type states the possible consequences of not avoiding the hazard.*

An icon, when present, gives a graphical description of the potential hazard.

Safety Message Example

WARNING



Risk of unexpected vehicle movement.

- **Block drive wheels before performing a test with engine running.**

A moving vehicle can cause injury.

Important Safety Instructions

For a complete list of safety messages, refer to the accompanying *Important Safety Instructions manual*.

SAVE THESE INSTRUCTIONS

2.1 Content

This manual contains basic operating instructions and is structured in a manner to help you become familiar with your diagnostic tool features and perform basic operations.

The illustrations in this manual are intended as reference only and may not depict actual screen results, information, functions or standard equipment. Contact your sales representative for availability of other functions and optional equipment.

2.2 Conventions

The following conventions are used.

2.2.1 Terminology

The terms “Scanner” and “Scanner function” are used to describe the Scanner Function(s) of the diagnostic tool.

Examples:

- Select **Scanner** from the Home screen.
- From the Scanner main menu select **Continue**.
- The Scanner function provides many diagnostic tests.

The term “select” describes tapping/touching an icon on the touch screen, or highlighting an icon or menu choice and then selecting the confirmation menu choice such as **Continue, Accept, OK, Yes, or other similar** choice.

Abbreviated example for the following procedure: “Select **Brightness**”

1. Navigate to and highlight the **Brightness** selection.
2. Select **OK, or similar**, button.

2.2.2 Symbols

Different types of arrows are used. The “greater than” arrow (>) indicates an abbreviated set of selection (navigation) instructions.

Abbreviated example for the following procedure: “Select **Tools > Connect-to-PC**”

1. Select **Tools** from the home screen.
2. Highlight **Connect-to-PC** on the Tools menu.
3. Select **Connect-to-PC**.

The solid arrows (◀, ▶, ▼, ▲) are navigational instructions for the four directions of the directional buttons.

Example: Press the down ▼ arrow.

2.2.3 Bold Text

Bold emphasis is used in procedures to highlight selectable items such as control buttons, icons and menu options.

Example: Press the **OK** button.

2.2.4 Notes and Important Messages

The following messages are used.

Notes

A NOTE provides helpful information such as additional explanations, tips, and comments.

Example:

**NOTE:**

For additional information refer to...

Important

IMPORTANT indicates a situation which, if not avoided, may result in damage to the test equipment or vehicle.

Example:

IMPORTANT:

Do not disconnect the data cable while the diagnostic tool is communicating with the ECM.

2.2.5 Hyperlinks

Hyperlinks, or hot links, that take you to other related articles, procedures, and illustrations are available in electronic documents. Blue colored text indicates a selectable hyperlink.

Example:

IMPORTANT:

Read all applicable ["Safety Information," on page 4](#) before using this diagnostic tool!

2.2.6 Procedures

An arrow icon in the left-margin area indicates a procedure.

Example:

**To change screen views:**

1. Select the **Graph** icon.
The dropdown menu displays.
2. Select an option from the menu.
The screen layout changes to the format selected.

This diagnostic tool allows you to communicate with various vehicle control systems (e.g. engine, transmission, antilock brake system (ABS), body, instrument cluster, etc) to:

- Perform OEM specific functional tests and relearn procedures
- Retrieve and clear diagnostic trouble codes (DTCs)
- View parameter (PID) data in text or graph format, and save it for future review
- Set and arm PID triggers to automatically capture and save PID data to buffer memory
- Access global OBD-II/EOBD service modes, freeze frame data, readiness monitors, and more

In addition you can:

- Quickly retrieve previously tested vehicles, to save setup time during repeat testing
- Save screen shots, to quickly capture specific data for future review
- Interface with ShopStream Connect™ software on your PC to transfer files from the diagnostic tool to your PC, download software updates and more.





This chapter introduces the basic features of the diagnostic tool, including the control buttons, data connections, battery pack and power sources. Technical Specifications are provided at the end of this chapter.

3.1 Control Buttons

There are four “push type” control buttons and one “thumb pad rocker type” multi-directional button located on the right side of the diagnostic tool. All other diagnostic tool operations are controlled through the touch screen.

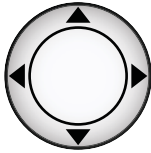

Figure 3-1 Front view

Item	Button	Description	
1		Y/✓ or Accept - Push type button	<ul style="list-style-type: none"> To confirm a selection from a menu or program. To select an item that was highlighted using the direction arrows. To advance to the next screen in a series. To answer “Yes” when a yes or no choice is given.
2		N/X or Cancel - Push type button	<ul style="list-style-type: none"> To exit a menu or program. To close an open list and return to the previous menu or screen. To answer “No” when a yes/no choice is given.
3		Directional - Thumb pad rocker type buttons	Buttons move the cursor or highlight in their respective direction: <ul style="list-style-type: none"> Up (▲) Down (▼) Left (◀) Right (▶)
4		(Shortcut) - Push type button	Programmable function button that can provide a shortcut for performing a variety of routine tasks. Refer to Configure Shortcut Button , on page 85 for additional information.
5		Power (On/Off) - Push type button	Turns the diagnostic tool on and off. Also, press and hold for 5 seconds for emergency shutdown.

3.2 Data and Power Connections

All diagnostic tool connections are located on the top of the diagnostic tool.

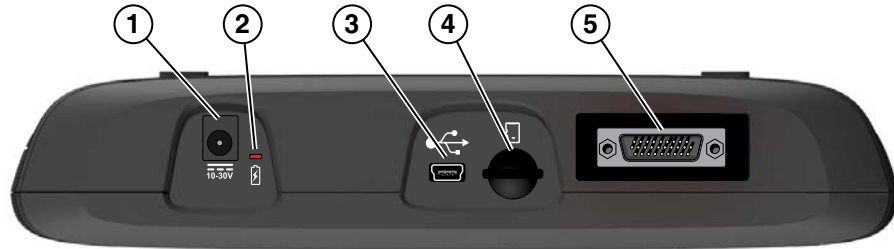

Figure 3-2 Top view

Item	Description
1	Power Supply Jack - connection for AC power supply
2	Battery Status Indicator LED <ul style="list-style-type: none"> • Green - battery is fully charged • Red - battery is charging • Amber - indicates there is a battery issue (correct before operating)
3	Mini-b USB Jack - connection for USB cable to a personal computer.
4	Micro secure digital (μSD) Card - contains operating system programming. IMPORTANT The μSD card must be installed for the diagnostic tool to operate. Do not remove the μSD card while the diagnostic tool is powered on.
5	Data Cable Connector - connection for vehicle data cable to vehicle data link connector (DLC).

3.3 Battery Pack Cover and Stand



- 1— **Built-in Stand** - The built-in stand extends from the back of the diagnostic tool and clips into the diagnostic tool for storage.
- 2— **Battery Pack Cover**
- 3— **Battery Pack Cover Screw**

Figure 3-3 Back view

3.4 Power Sources

Your diagnostic tool can be powered from any of the following sources:

3.4.1 Vehicle Power

All OBD-II/EOBD vehicles have vehicle battery power (B+) available on the DLC. The diagnostic tool is powered through the Data Cable when connected to the vehicle DLC. A green LED indicator on the DLC end of the data cable, illuminates when power is being supplied to the cable. If the LED fails to illuminate, check that the data cable is properly connected and then check the DLC power circuit. See [Data Cable Connection \(Automotive\)](#), on page 19 for additional data cable information.

3.4.2 Internal Battery Pack

The diagnostic tool can be powered from the internal rechargeable battery pack. A fully charged battery provides sufficient power for about 3 hours of continuous operation.

Battery charging occurs when the diagnostic tool is connected to the AC Power Supply and to a live AC power source, or when the data cable is connected to an OBD-II/EOBD vehicle.

The Battery Status Indicator LED (located next to the power supply jack) indicates battery status ([Figure 3-3](#)).

- **Green** - indicates battery is fully charged
- **Red** - indicates battery is charging
- **Amber** - indicates a battery issue. This may be caused by excessive battery temperature (above 104°F/40°C), which disables charging. Allow the diagnostic tool to cool down before continuing operation.

3.4.3 AC Power Supply

The diagnostic tool can be powered from a standard AC outlet using the AC power supply. The connector on the end of the output cable of the AC power supply attaches to the power supply input jack on top of the diagnostic tool. Use only the AC power supply provided.

IMPORTANT:

Never connect the AC power supply to the power supply input on the diagnostic tool when the diagnostic tool is communicating with a vehicle.

3.5 Technical Specifications

Item	Description / Specification
Touch Screen	Resistive Touch Panel
Display	5.6 inch diagonal, LCD TFT
	640 x 480 resolution
	24 bit color
Battery Pack	Rechargeable lithium-ion battery pack
	Approximately 3 hour run time
	Approximately 5 hour charge time
Operating System	SMX
Processor	Motorola
Input Operating Voltage	10 to 30VDC
AC Power Supply Rating	Input 110-240VAC, Output 15VDC - 2A
Width	8.90 in. (226 mm)
Height	5.67 in. (144 mm)
Depth	1.75 in. (44.5 mm)
Weight (including battery pack)	2.1 lb (952 g)
Operating Temperature Range (ambient)	At 0 to 90% relative humidity (non-condensing) 32 to 113°F (0 to 45°C)
Storage Temperature (ambient)	At 0 to 70% relative humidity (non-condensing) -4 to 140°F (-20 to 60°C)
Environmental Conditions	This product is intended for indoor use only
	This product is rated for Pollution Degree 2 (normal conditions)

Basic Operation and Navigation

This chapter describes basic operation, navigation, screen layout, and icon functions. Before you operate the diagnostic tool, make sure the battery pack is fully charged or the diagnostic tool is powered by the AC power supply.

4.1 Turning On/Off and Emergency Shutdown

The following sections describe how to turn the diagnostic tool on and off and how to perform an emergency shutdown.

4.1.1 Turning On

The diagnostic tool will automatically turn on and open the Home screen ([Figure 4-1](#)) when power is supplied through the Data Cable or by the AC Power Supply. If the diagnostic tool does not automatically turn on, press and release the Power button on the front of the diagnostic tool to turn the diagnostic tool on.

4.1.2 Turning Off

IMPORTANT:

All vehicle communication must be terminated **BEFORE** turning off the diagnostic tool. A warning message displays if you attempt to turn the diagnostic tool off while communicating with the vehicle. Forcing a shut down while communicating may lead to ECM problems on some vehicles. Never disconnect the Data Cable when the diagnostic tool is communicating with the vehicle ECM.

**To turn off the diagnostic tool:**

1. Press the **N/X** button or select the **Back** or **Home** icon to navigate to the Home screen.
If vehicle communication is active, the “stopping communication” message appears briefly before the Home screen displays.
2. Disconnect the diagnostic tool Data Cable from the vehicle.
3. Press and release the **Power** button.
A confirmation screen displays.
4. Press the **Y/✓** button or select **OK** from the menu to turn the diagnostic tool off. To continue operating, press the **N/X** button or select **Cancel** from the menu.

4.1.3 Emergency Shutdown

IMPORTANT:

Using the emergency shutdown procedure while communicating with a vehicle may lead to control module problems on some vehicles.

During normal operation turn the diagnostic tool off using the *Turning Off* procedure described previously. The emergency shutdown procedure should only be used if the diagnostic tool does not respond, or exhibits erratic or abnormal operation. To force an emergency shutdown, press and hold the **Power** button for five seconds until the diagnostic tool turns off.

4.2 Basic Navigation

4.2.1 Home Screen Layout

The Home screen includes the title bar and function icons.



1— Title Bar

2— Function Icons

Figure 4-1 Home screen

4.2.2 Title Bar

The title bar at the top of the screen (Figure 4-1) provides basic information about current diagnostic tool operating conditions. Title bar options vary depending upon vehicle make and model, what function is active, what test is being performed, or what menu is selected. The title bar contains information only, there are no selectable items.



Figure 4-2 Typical Title Bar (showing vehicle information)

Information the title bar may display (varies upon active function):

- Active diagnostic function.
- Active communication indicator icon.
- Current time.
- Wi-Fi signal strength
- Source and status of the power being supplied to the diagnostic tool.
- The identification (ID) of the test vehicle
- The name of the test being performed

An active function icon is always displayed in the title bar. These icons resemble their Home screen icon counterparts in appearance and color. The name of the function displays to the right of the icon on some screens.

A clock is displayed in the title bar, and is powered by a dedicated internal battery, so the correct time is maintained even when the battery pack is discharged. See [Clock Settings](#), on page 91, for clock setting instructions.

Table 4-1 Title Bar Icons





Icon	Function	Icon	Function
	Full Battery Charge Level - Indicates power is being supplied by the internal battery pack. Horizontal bars diminish as the battery discharges.		Active Vehicle Communication - Indicates the diagnostic tool is actively communicating with a vehicle.
	Low Battery Charge Level - Indicates the internal battery pack is low and needs to be recharged immediately. A warning message will also display on the screen when the battery gets low.		Wi-Fi Signal Strength - Indicates signal strength of the wireless network connection. Three bars - indicate full strength signal Zero to 1 bar - indicate weak or no signal
	External Power Connected - Indicates power is being supplied through the data cable connection to a vehicle or by the AC Power Supply.		

4.2.3 Home Screen Icons

Each available diagnostic tool function is represented by a function icon on the home screen.





Select an icon from the Home (touch) screen to start a function. You can also use the control buttons to start a function. Use the directional buttons (◀, ▶, ▲, ▼) to highlight (a yellow border around the icon indicates it is highlighted) the desired function and then press the **Y/✓** button to select it. A “please wait” message may display briefly, then automatically clear once the function is loaded and ready for use.

Table 4-2 Home screen icons

Function Name	Function Icon	Description
Scanner		Used to communicate with the electronic control systems of a vehicle. This function allows you to retrieve diagnostic trouble codes (DTCs), view PID data and perform diagnostic tests. See Scanner - Automotive , on page 27, for details.
OBD-II/EOBD		Allows you to access generic OBD-II/EOBD data and tests without identifying the vehicle being tested. See OBD-II/EOBD , on page 53, for details.
Quick Lookups		Allows you quickly access OEM Oil and Tire/Wheel specifications and instructions on your diagnostic tool. See Quick Lookups , on page 64,.
Previous Vehicle & Data		Allows you to quickly reconfigure the diagnostic tool to a recently tested vehicle and to access saved data files. See Previous Vehicles and Data , on page 79, for details.
Tools		Allows you to adjust diagnostic tool settings to your personal preferences and perform other special functions. See Tools , on page 83, for details.

4.2.4 Common Toolbar Control Icons

Common control icon functions are described in the following table. Specific function control icons are described in their applicable chapters. Displayed control icons vary depending on the active function or test. Select a control icon on a screen to activate a control function. You can also use the control buttons to activate a function, a yellow border around the icon indicates it is highlighted, or in focus. Use the Directional buttons (◀, ▶, ▲, ▼) to highlight the desired function and then press the **Y/✓** button to select it.

Icon	Function	Icon	Function
	Back - Returns to the previously viewed screen. Icon is located on the left-hand edge of the toolbar.		Save - Writes data from buffer memory to a file. The saved "movie" file can be accessed for future reference by selecting Previous Vehicles and Data > View Saved Data .
	Home - Returns to the Home screen. Icon is located next to the Back icon on the left side of the toolbar.		Tools - Opens the tools menu.

4.2.5 Scroll Bar

A vertical scroll bar appears along the right-hand edge of the screen when there is more data than can be displayed (Figure 4-3).

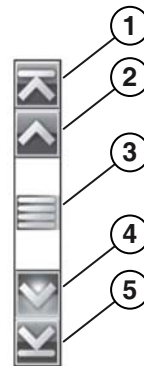

Figure 4-3 Scroll bar

- 1— **Beginning** - Moves to beginning of the data.
- 2— **Step up** - Moves up one increment of the data.
- 3— **Slider (position indicator)** - Select and drag the **Slider** to scroll through data. The slider indicates the relative position of the current screen to the total available data.
- 4— **Step down** - Moves down one increment of the data.
- 5— **End** - Moves to end of the data.

The Up (▲) and Down (▼) directional buttons can also be used to move through the data one line at a time. Press and hold a directional button to rapidly scroll through data.

4.3 Screen Messages

4.3.1 System Messages

There are four types of system messages that may be displayed:

Message Type	Description
Loading and Connecting	Loading and connecting messages display when the diagnostic tool is performing an internal operation, such as loading a database, establishing communications with the vehicle, or initiating a test. The message automatically clears once the internal operation is complete.
Confirmation	Confirmation messages inform you when you are about to perform an action that cannot be reversed or when an action has been initiated that requires a confirmation to continue. When a response is not required, the message displays briefly, then disappears.
Warning	Warning messages inform you when completing the selected action may result in an irreversible change or in the loss of data. A confirmation is required to continue.
Error	Error messages inform you when a system or procedural error has occurred, for example if the data cable becomes disconnected during operation.

4.3.2 Communication Messages

When “no communication” messages are displayed, it indicates the diagnostic tool and the vehicle electronic control module are not communicating.

The following conditions may cause “no communication” messages to display:

- The diagnostic tool is unable to establish a communication link with the vehicle.
- The vehicle is not equipped with the system that was selected.
- There is a loose connection.
- There is a blown vehicle fuse.
- There is a wiring fault on the vehicle.
- There is a circuit fault in the data cable or adapter.
- Incorrect vehicle identification was entered.

4.4 Data Cable Connection (Automotive)

Connection of the data cable to the diagnostic tool and vehicle data link connector (DLC) is required for Scanner and OBD-II/EOBD testing.

Depending on the vehicle, the supplied DA-4 data cable may be used alone or may require optional adapters.

- **All OBD-II/EOBD compliant vehicles** - Use the supplied DA-4 data cable. The 26-pin end of the cable attaches to the data cable connector on the top of the diagnostic tool (secure with captive screws). The 16-pin end connects to the vehicle DLC.
- **All non-OBD-II/EOBD (OBD-I) compliant vehicles** - Use the supplied DA-4 data cable with the optional DA-5 adapter and a manufacturer specific adapter. The 26-pin end of the cable attaches to the data cable connector on the top of the diagnostic tool. The 16-pin end connects to the DA-5 adapter, the DA-5 adapter connects to the manufacturer specific adapter and then connects to the vehicle DLC.

On-screen cable and adapter connection instructions may be provided while using the Scanner and OBD-II/EOBD functions. The instructions may also include the location of the vehicle DLC ([Figure 4-4](#)).

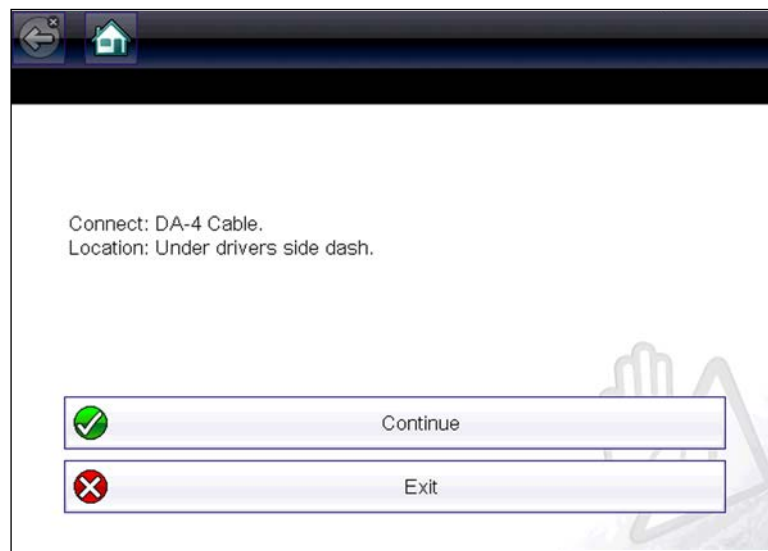

Figure 4-4 Vehicle connection data cable message

For data cable vehicle power connection information, see [Vehicle Power](#), on page 11,.

This chapter provides step-by-step instructions that allow you to get started using the diagnostic tool and become familiar with some of the common Scanner and OBDII functions. Two built-in demonstration modes allow you to walk-through these functions without connecting to a vehicle:

- [Scanner Demonstration](#)
- [OBD-II/EOBD Demonstration](#)

IMPORTANT:

Do not connect the diagnostic tool to a vehicle when using the demonstration modes.

5.1 Scanner Demonstration

The Scanner demonstration program allows you to navigate through many functions of the Scanner, and displays vehicle data (PIDs) and trouble codes (captured from actual vehicle) to simulate what you might see on an actual vehicle.

Links are provided (as applicable) within the demonstrations to additional topic information in this manual.

The following Scanner demonstrations are intended to be completed in sequence:

- 1 - Vehicle Identification
- 2 - Scan for Engine Codes and Save the Codes
- 3 - View, Configure and Save Engine Data (PIDs)
- 4 - Perform a Functional Test
- 5 - Perform a Code Scan
- 6 - View Saved Files (Codes, Code Scan and Data Files)
- 7 - Activate a Previously Identified Vehicle and View Engine Data (PIDs)



Scanner Demo 1 - Vehicle Identification

The first process in communicating with any vehicle is identifying the vehicle. The following walk-through will guide you through this process using the Scanner demonstration mode.

1. From the Home screen, select **Scanner** .
2. Select **Automotive**.
3. The manufacturer (vehicle make) menu displays, select **Demonstration**.
4. Select **Chevrolet**.

IMPORTANT:

Do not connect a vehicle to the diagnostic tool while using the Demonstration program.

The simulated Vehicle ID process starts. The demonstration vehicle to be identified is a 2016 Chevrolet Tahoe, 5.3L, 4WD.

5. The year menu displays, select **2016-G**
6. The model menu displays, select **Tahoe (4WD) Demo - K**
7. The engine menu displays, select **5.3 V8 (L83) - C**
8. The vehicle confirmation screen displays, select **OK**. (Selecting OK loads the specific vehicle database, in this instance it's our demonstration database).
9. A message displays **"Demo mode: Do not connect to vehicle."** Select **Continue**.

For more on vehicle identification, see [Vehicle Identification](#), on page 30.

After the vehicle has been identified, a systems menu displays This menu shows all of the vehicle systems available (supported by the vehicle) for testing. Typical systems choices may include:

• Code Scan	• Body Control Module	• Radio
• Clear All Codes Read by Code Scan	• Door Module - Driver	• Seat Module - Driver
• Engine	• Door Module - Passenger	• Suspension (ESC). If Equipped.
• Transmission	• Heating and Air Conditioning	• Theft Deterrent
• Antilock Brakes	• Instrument Panel Cluster	• Tire Pressure Monitor
• Airbag	• Passenger Presence System	• Transfer Case

Most of the system menu choices are directly related to a specific vehicle system (e.g. Engine, Airbag, Tire Pressure Monitor), with the exception of Code Scan and Clear All Codes Read by Code Scan. Code Scan is a time-saving feature that allows you to scan all the vehicle systems at once for diagnostic trouble codes (DTCs). For more on Code Scan, see [Code Scan](#), on page 34.



Choosing a vehicle system opens the main menu for that system which provides options for you to analyze and interact with that system. You can choose to scan for DTCs, clear DTCs, view parameter data (PIDs), perform functional tests and more. For more on System Menu options, see [System Main Menu Options](#), on page 37.

10. Proceed to *Scanner Demo 2*.



Scanner Demo 2 - Scan for Engine Codes and Save the Codes

This demonstration simulates performing a typical check for engine trouble codes, and saving the codes for review at a later time.

1. Select **Engine**.
2. Select **Codes Menu > Display Codes > DTC Display**.
A list of current DTCs is displayed.
For more on the Code Menu, see [Codes Menu](#), on page 37.
3. Select **Save** . A confirmation message will briefly display to inform you that the data file has been saved.
4. Press **Back**  three (3) times to return to the Main Menu (Engine).
5. Proceed to *Scanner Demo 3*

**Scanner Demo 3 - View, Configure and Save Engine Data (PIDs)**

This demonstration simulates viewing engine data (PIDs) in list and graph views, creating a custom data list, and saving the data for review at a later time.

Viewing PIDs:

1. From the Main Menu (Engine), select **Data Display > Engine Data**.
The Engine Data list is displayed showing all supported PIDs. Use the scroll bar to view all the data.

Changing the displayed view:



2. Select **View**  and then select **PID list** (to display PIDs in a list format) or **4 graphs** (to display 4 PID graphs onscreen). Use the scroll bar to view all the data.

For more on changing data display views, see [Changing Screen Views](#), on page 41.

Saving a PID data file:

3. Select **Save** . A confirmation message will briefly display to inform you that the data file has been saved.

Creating a custom PID list:

4. Select **Custom Data** , then select the **Deselect All** .
5. Select **Engine Speed (RPM)**, **MAF (g/s)**, and **HO2S B1 S1 (mv)** from the list. A check mark appears in the box to indicate a selected item.

For more on customized PID lists, see [Customizing the Data List](#), on page 41.

6. Select **Back** .

You have just created a custom PID list. To change your list, select the Custom Data icon again and modify your selection.

7. Press **Back**  two (2) times to return to the Main Menu (Engine).
8. Proceed to *Scanner Demo 4*

**Scanner Demo 4 - Perform a Functional Test**

This demonstration simulates performing a functional component test.

**NOTE:**

This functional test demonstration is intended to show a typical testing scenario. The data displayed will not change when performing a test, as it may when testing an actual vehicle.

1. From the Main Menu (Engine) select **Functional Tests**.
2. Select **Output Controls > EVAP VENT SOLENOID VALVE**
3. A message displays “Test will not function correctly if on-board EVAP diagnostic is running.”, select **Continue**.
The test screen displays showing PIDs related to the system being tested and a functional test icon at the top labeled EVAP VENT SOLENIOD VALVE.
4. Select the **EVAP VENT SOLENIOD VALVE** icon and choose an option **Venting** or **Not Venting**. Notice the current state is indicated “**Venting** or **Not Venting**” in the title bar just above the data list on the right side. Toggle the functional icon **Venting** or **Not Venting** to see the status change.
5. Press **Back**  four (4) times to return to the Systems Menu.
6. Proceed to *Scanner Demo 5*



Scanner Demo 5 - Perform a Code Scan

This demonstration simulates performing a typical code scan of all supported vehicle systems, and saving the code scan data.

1. From the Systems Menu select **Code Scan**.

The Code Scan results screen displays and starts the automated process of scanning vehicle systems for codes. A status indicator is displayed at the top of the list as the scan is performed.

2. Use the scroll bar to view the complete list.
3. Select **Save** . A confirmation message will briefly display to inform you that a file has been saved.

For more on Code Scan, see [Code Scan](#), on page 34.

4. Press **Home**  to return to the Home screen.
5. Proceed to *Scanner Demo 6*



Scanner Demo 6 - View Saved Files (Codes, Code Scan and Data Files)

This demonstration walks you through opening the data files saved in the previous demos.

1. From the Home screen select **Previous Vehicles and Data** .
2. Select **View Saved Data**.



A list of all saved files is displayed (most current at top).

- Code data and Code Scan files are saved with an .XML file extension and show the date saved and vehicle information.
 - Engine data files are saved with with a .SCM file extension and also show the date saved and vehicle information.
3. Select the saved data file to view it. If needed, use the scroll bar to view all the data.
For more on viewing data files, see [View Saved Data](#), on page 80.
 4. Select **Back**  to return to the Previous Vehicles and Data main menu.
 5. Proceed to *Scanner Demo 7*



Scanner Demo 7 - Activate a Previously Identified Vehicle and View Engine Data (PIDs)

This demonstration simulates activating a previously identified vehicle, and viewing engine data.

1. From the Previous Vehicles and Data main menu select **Vehicle History**.
A list of all previously identified vehicles is displayed.
For more on Vehicle History, see [Vehicle History](#), on page 79.
2. For the purpose of this exercise we will select our same demo vehicle, select **2014 Chevrolet Tahoe, 5.3L, 4WD**. **Note:** If other vehicles have been previously identified, they will display in the list.
3. A vehicle confirmation screen displays, select **Continue**.
4. A message displays “**Demo mode: Do not connect to vehicle.**”, select **Continue**.
5. From the Main Menu (Engine), select **Data Display > Engine Data**.
The Engine Data list is displayed showing all supported PIDs. Use the scroll bar to view all the data.
6. Select **Back**  two times (2) to return to Main Menu (Engine), or select **Home**  once to return to the Home screen.

End of Scanner demonstration.

To become familiar with other capabilities of the Scanner function, navigate through the other services and menu options within the Scanner Demonstration Mode. Also, watch our product training videos on our website at: <https://diagnostics.snapon.com/trainingsolutions>

5.2 OBD-II/EOBD Demonstration

The OBD-II/EOBD training program allows you to navigate through many functions of OBD-II/EOBD, and displays vehicle data (PIDs) and trouble codes (captured from actual vehicle) to simulate what you might see on an actual vehicle.

Links are provided (as applicable) within the demonstrations to additional topic information in this manual.



NOTE:

The OBD-II/EOBD function allows you to access “generic” OBD-II/EOBD data (data limited to emission related diagnostics only). The Scanner function allows you to access vehicle specific systems, parameters and enhanced diagnostics.

The following OBD-II/EOBD demonstrations are intended to be completed in sequence:

- 1 - **Start Communication / Vehicle Identification**
- 2 - **Check Monitors Complete This Cycle**
- 3 - **Display Current Data**
- 4 - **Display Trouble Codes**
- 5 - **Display and Save Freeze Frame Data**

**OBD-II/EOBD Demo 1 - Start Communication / Vehicle Identification**

This demonstration starts the OBD-II/EOBD training demonstration, simulating typical vehicle connection and identification.

1. From the Home screen, select **OBD-II/EOBD** .
2. The main menu displays, select **OBD Direct**.

IMPORTANT:

Do not connect a vehicle to the diagnostic tool while using the Demonstration program.





3. Select **OBD Training Mode**.
4. Select **Start Communication**.
5. The demonstration vehicle data is loaded and a confirmation screen displays, select **Continue**.

For more on OBD communication, see [Start Communication](#), on page 57.

6. The OBD-II/EOBD Service menu displays.
7. Proceed to *OBD-II/EOBD Demo 2*.

**OBD-II/EOBD Demo 2 - Check Monitors Complete This Cycle**

This demonstration simulates a typical check of OBD monitors that have run during the current drive cycle.

1. From the OBD-II/EOBD Service menu, select **Readiness Monitors**.
2. Select **Monitors Complete This Cycle**.
3. With the monitor data displayed, select **View**  and then select **PID list** (to display as a list).
4. A list of monitors is displayed showing status indication (e.g. Test Complete , Not Supported , or Not Complete ).

Note: Use the scroll bar to view all the data.



For more on readiness monitors, see [Readiness Monitors](#), on page 56.

- Select **Back**  two (2) times to return the OBD-II/EOBD Service menu.
5. Proceed to *OBD-II/EOBD Demo 3*.

**OBD-II/EOBD Demo 3 - Display Current Data**

This demonstration simulates a typical check of current OBD data, viewing OBD data (PIDs) in list and graph views, and creating a custom data list.



1. From the OBD-II/EOBD Service menu select **(\$01) Display Current Data**.
The Engine Data list is displayed. This list shows all supported PIDs, use the scroll bar to view all the data.

2. Select **Custom Data** , then select the **Deselect All** .
3. Select **Short Term Fuel Trim Bank 1(%)** and **Short Term Fuel Trim Bank 2(%)**.
4. Select **Back** .

You have just created a custom PID list. To change your list, select the Custom Data icon again and modify your selection.

5. With the data displayed, select **View**  and then select **PID list** (to display PIDs in a list) or **2 graphs** (to display each PID as a graph).

Notes:

- Use the scroll bar to view all the data in the file, if needed.
- Use the navigation controls to navigate through the data.
- Select the View icon  to view the data as a list or graphs.
- Select the Zoom icon  to view data detail in the graph.

For more on displaying current OBD data, see [\(\\$01\) Display Current Data](#), on page 60.

6. Select **Back**  to return to the OBD-II/EOBD Service menu.
7. Proceed to *OBD-II/EOBD Demo 4*.







**OBD-II/EOBD Demo 4 - Display Trouble Codes**

This demonstration simulates a typical check of current OBD trouble codes.

1. From the OBD-II/EOBD Service menu select **(\$03) Display Trouble Codes**.
A list of OBD trouble codes (DTCs) is displayed.
For more on displaying OBD trouble codes, see [\(\\$03\) Display Trouble Codes](#), on page 60.
2. Select **Back**  to return to the OBD-II/EOBD Service menu.
3. Proceed to *OBD-II/EOBD Demo 5*.

**OBD-II/EOBD Demo 5 - Display and Save Freeze Frame Data:**

This demonstration walks you through a typical check of OBD Freeze Frame data, and shows how to save and review the data.

1. From the OBD-II/EOBD Service menu select **(\$02) Display Freeze Frame Data**.
A freeze frame list of data is displayed. **Note:** Use the scroll bar to view all the data.
For more on displaying OBD freeze frame data, see [\(\\$02\) Display Freeze Frame Data](#), on page 60.
2. Select **Save** . A confirmation message will briefly display to inform you that a file has been saved.
3. Select **Back**  once, then press **Home**  once to return to the Home screen.
4. From the Home screen select **Previous Vehicles and Data** .
5. Select **View Saved Data**.
A list of all saved files is displayed (most current at top). OBD-II/EOBD Freeze Frame files are saved with an .SCM file extension, show the date saved and are labeled OBD.
6. Select the saved Freeze Frame file to view it.
Notes:
 - Use the scroll bar to view all the data in the file, if needed.
 - Use the navigation controls to navigate through the data.
7. Select **Back**  once, then press **Home**  once to return to the Home screen.
For more on viewing saved data, see [View Saved Data](#), on page 80.

End of OBD-II/EOBD demonstration.

To become familiar with other capabilities of the OBD-II/EOBD function, navigate through the other services and menu options within the OBD Training Mode. Also, watch our product training videos on our website at: <https://diagnostics.snapon.com/trainingsolutions>

This chapter describes the basic operation of the automotive Scanner function. For motorcycle applications see [Scanner - Motorcycle](#), on page 48.



The **Scanner** icon is located on the Home screen.

The Scanner function allows your diagnostic tool to communicate with the electronic control systems of a vehicle. This allows you to retrieve diagnostic trouble codes (DTCs), view PID data and perform diagnostic tests.

6.1 Scanner Demonstration Program

The Scanner demonstration program displays actual vehicle data that allows you to navigate and become familiar with the many capabilities of the Scanner function without actually connecting to a vehicle. The following sections in this chapter provide detailed information on navigating through the Scanner function and various menus. As you navigate through the Demonstration program, refer to the applicable section for additional information.



To start the demonstration program:

1. From the Home screen, select the **Scanner** icon.
2. Select **Automotive**.
The manufacturer menu displays.
3. Select the **Demonstration** icon.

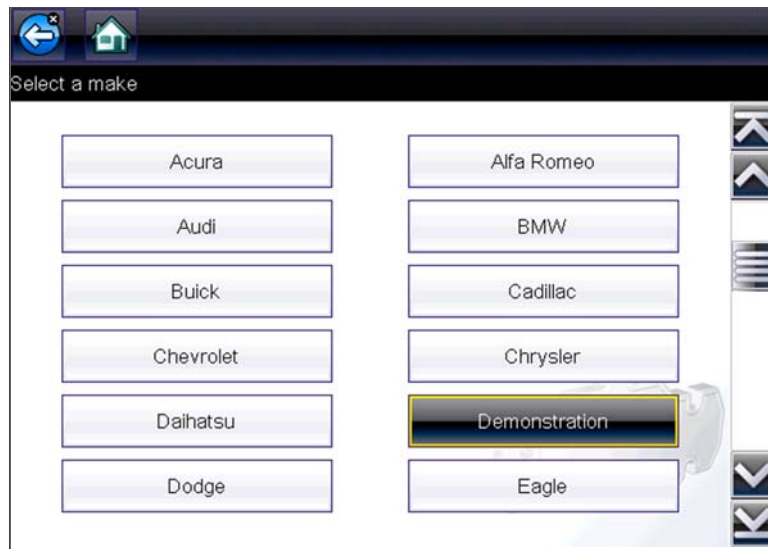

Figure 6-1

IMPORTANT:

Do not connect a vehicle to the diagnostic tool while using the Demonstration program.

4. Follow the on-screen instructions and make the selection as needed until the confirmation screen displays.
5. Select **OK** on the confirmation screen to load the demonstration database.
A message displays “Demo mode: Do not connect to vehicle.”
6. Select **Continue**.
A systems menu, which shows all of the systems available for testing, displays.
7. Select a system from the menu, then select submenus as applicable to display the desired demonstration information.

6.2 Screen Layout and Toolbar Icons

The following screen layout and toolbar controls apply to both the Scanner and the OBD-II/EODB functions.

6.2.1 Screen Layout



1— Title bar—shows active test, vehicle and diagnostic tool status

2— Toolbar—contains control icons











3— Main body—displays menus, PID and test data

Figure 6-2 Screen layout

The Title bar appears for all functions and displays information only, there are no selectable items. Refer to [Title Bar](#), on page 15 for details.

6.2.2 Scanner Control Icons

The scanner toolbar contains control icons. Control icons may vary depending on the active function or test. A yellow frame surrounding an icon (highlighted), indicates it is selected. Other control icons (not shown) are described in [Common Toolbar Control Icons](#), on page 17.

Icon	Function	Icon	Function
	Pause - Indicates PID data from the vehicle is being displayed. Selecting pauses data collection.		Custom Data List - Opens a menu for selecting which PIDs display in the list.
	Clear - Erases all the PID data in the buffer and begins a new recording. Selecting opens a confirmation message.		Change View - Changes display options between PID list or graph displays.
	Trigger - Opens a menu that allows you to set, arm, and clear threshold values that automatically trigger PID data to be saved from buffer memory to a file.		Lock/Unlock - Locks or unlocks the highlighted parameter. Locked PIDs move to the top of the list and do not scroll as you move through the data.
	Zoom - Incrementally increases and decreases the scale of the data being displayed.		Sort - Determines the order in which PIDs are listed on the screen.
	Record - Indicates the data being displayed is paused and not being updated. Selecting resumes data collection.		
The control icons below are used to navigate through paused or saved "movie" files during playback.			
	Step Forward - allows forward movement in singular steps. To quickly step forward, select this icon (yellow frame appears) then press and hold the Y/✓ button. Note: To quickly step forward during Scanner data playback, press and hold the icon down. During this mode a red frame appears around the icon.		Step Back - allows backward movement in singular steps. To quickly step backward, select this icon (yellow frame appears) then press and hold the Y/✓ button. Note: To quickly step backward during Scanner data playback, press and hold the icon down. During this mode a red frame appears around the icon.

6.3 Scanner Operation



NOTE:

For instructions on connecting to Fiat® Chrysler® Automobiles (FCA) with a Secure Gateway Module, from the Home screen select **Tools > Get Connected**. Also visit: snapon.com/gateway

6.3.1 Vehicle Identification

The vehicle must be correctly identified for the diagnostic tool to communicate, and display data correctly. Menus and navigation will vary by vehicle.

Depending on the vehicle, the vehicle identification process may require manual entry of the vehicle information, or it may be automated. The following three Scanner functions are available to identify the vehicle:

Instant ID - Automatically completes the identification process upon initial communication between diagnostic tool and the vehicle using OBD-II VIN mode \$09. Instant ID requires specific vehicle support and procedures, see [Instant ID](#), on page 33 for additional information.

Auto ID - Automatically completes the identification process after the vehicle make and year are manually entered.

Manual ID - Allows for manual entry of all required vehicle identification criteria.



Use the following procedure to identify a vehicle.



NOTE:

The following procedure applies to most OBD-II vehicles, and may vary depending on the vehicle. Not all vehicles support the Instant ID and/or Auto ID functions.

1. Connect the data cable to the diagnostic tool. See [Data Cable Connection \(Automotive\)](#), on page 19.
2. Turn the vehicle ignition switch on.
 1. Connect the data cable to the vehicle data link connector (DLC). See [Data Cable Connection \(Automotive\)](#), on page 19.



NOTE:

If the diagnostic tool is off, when the OBD-II data cable is connected to the vehicle DLC, the diagnostic tool should automatically turn on. If the tool did not turn on when the data cable was connected to the vehicle, check the vehicle DLC for power. Most OBD-II vehicles supply power to the DLC, which in-turn supplies power and turns on the diagnostic tool when the cable is connected.

2. If required, turn the diagnostic tool on.
3. Depending on the vehicle:
 - a. Instant ID may occur, as indicated by an audible "beep" sounded within 5 seconds after the diagnostic tool turns on. Select the **Scanner** icon, then wait for the vehicle confirmation screen ([Figure 6-3](#)) and select **OK** to continue. Then proceed to **step 6**. See [Instant ID](#), on page 33, for additional information about this function.

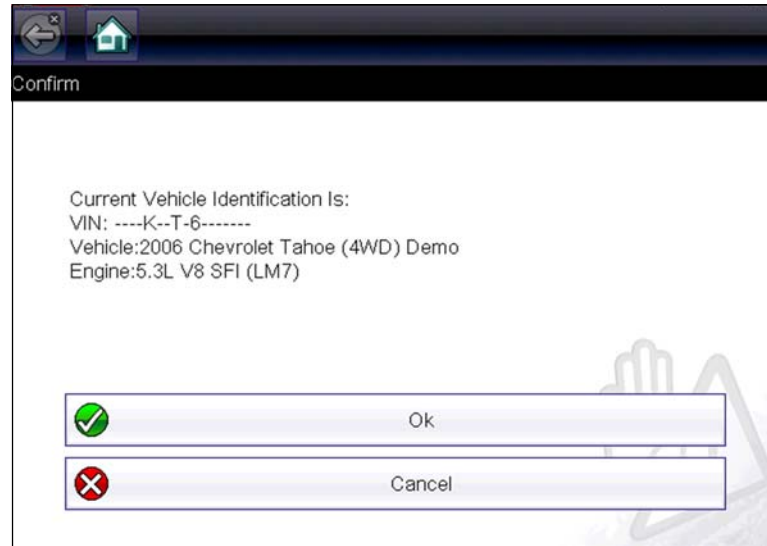

Figure 6-3 Vehicle confirmation screen

- b. If Instant ID is not supported, you will be prompted to select the vehicle make and year (if needed). Then a menu option is displayed to choose either **Automatic ID** or **Manual ID**.

- Selecting **Automatic ID** (if supported by the vehicle) will briefly display a communications screen informing you that the diagnostic tool is attempting to establish communication with the vehicle and determine vehicle identification.

Once the vehicle has been identified, the vehicle confirmation screen displays. If the vehicle information is correct, select **OK** to continue, then proceed to step 6.

If the vehicle does not support Auto ID, the diagnostic tool will attempt to identify the vehicle and then display a message indicating that vehicle identification cannot be made. If this occurs, proceed to "**Selecting Manual ID**" next.

- **Selecting Manual ID** allows you to manually enter all the vehicle information to identify the vehicle.
 - b1.) Follow the screen prompts to enter all the information required to identify the vehicle.
 - b2.) Once the vehicle has been identified, the vehicle confirmation screen displays (Figure 6-3). If the vehicle information is correct, select **OK** to continue, then proceed to step 6.

4. After the vehicle is identified, a menu of available systems, and options are displayed. Select a system or option (Figure 6-4).

**NOTE:**

Only the systems and options supported for the vehicle are included in the menu list.

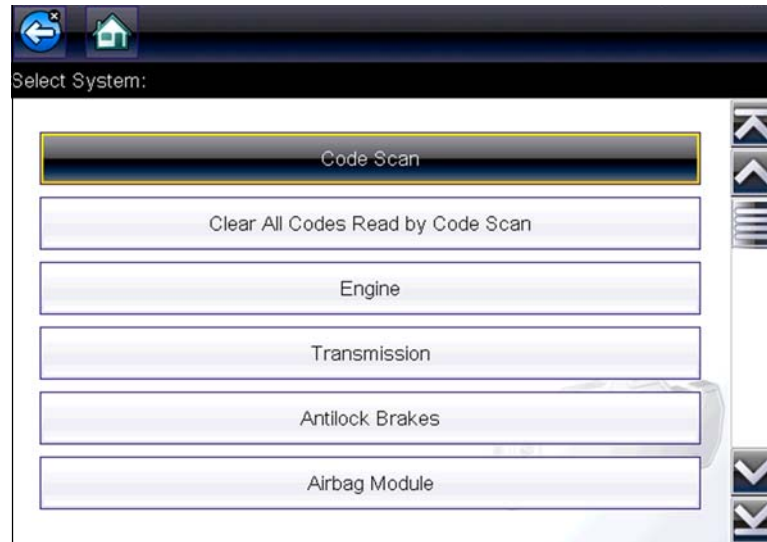

Figure 6-4 Typical systems menu

If a system (e.g. Engine, Transmission, Antilock Brakes, etc) is selected, the diagnostic tool may establish communication with the vehicle, then display the system main menu (available tests) (Figure 6-5). For sub-menu option information, see [System Main Menu Options](#), on page 37.

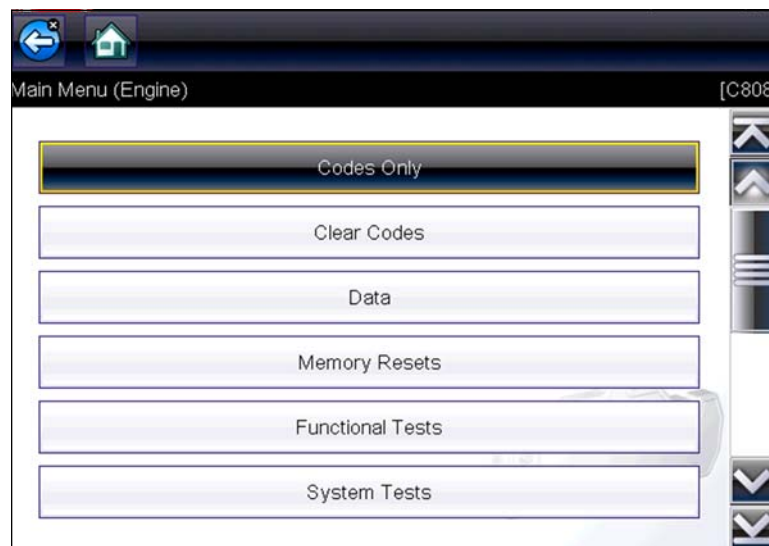

Figure 6-5 System main menu

Instant ID

The Instant ID function, can save time when initially identifying a vehicle, by automatically communicating with the vehicle to complete the vehicle identification process.

This function requires specific vehicle support requirements, and connection procedures to operate.

- **Vehicle requirements:**

- Vehicle must support Mode \$09 VIN.
 - **Note:** *Mode \$09 VIN is mandated on 2008 and newer vehicles.*
- Vehicle must be equipped with Hi Speed CAN or J1850 communication protocol.

- **Connection procedure requirements:**

- 1.) Turn the vehicle ignition on.
- 2.) Connect the data cable to the diagnostic tool.
- 3.) Connect the data cable to the vehicle data link connector (DLC).
- 4.) The diagnostic tool should turn on automatically. If required, turn the diagnostic tool on. An audible "beep" will be sounded within 5 seconds of the diagnostic tool being turned on, if the VIN is read.

Note: *No visual confirmation is displayed.*

- 5.) Select **Scanner**.

When Scanner is selected, a screen may briefly appear informing you the diagnostic tool is attempting to automatically complete the vehicle identification process.

- 6.) After the vehicle has been identified, the vehicle confirmation screen displays. If the vehicle information is correct, select **OK** to continue.

**NOTE:**

Depending on the vehicle, Instant ID may occur automatically and only ask you to confirm the vehicle, or additional screen prompts may be displayed to enter vehicle information.

**NOTE:**

If the Scanner feature is exited during the session that Instant ID was used, selecting Scanner again, will not ID the vehicle again. To quickly ID the vehicle again, select it from **Previous Vehicles and Data > Vehicle History**.

If the vehicle is not automatically identified, follow the screen prompts to enter the information required to identify the vehicle.

6.3.2 Code Scan

One of the benefits of performing a code scan is that you can quickly show your customer diagnostic related issues with a pre scan report, and then after repairing the issues you can use the post scan report to show that the repairs were completed (Figure 6-6). In addition, by using ShopStream Connect the reports can be given to the customer and also saved for your own records, for more information, see [ShopStream Connect](#), on page 106.

IMPORTANT:

PRE / POST Scan Importance - As many systems do not turn on the check engine light or other indicator, performing a vehicle code scan before making any repairs may help in troubleshooting, by identifying possible unknown issues that may be related to the present symptoms.

Performing pre and post scans also allows you to record in report format the pre-condition of the vehicle and compare the post scan after work is complete to confirm the repairs were completed properly.

Pre and post scan is required by some manufacturers for pre and post collision work as well as by some insurance companies.

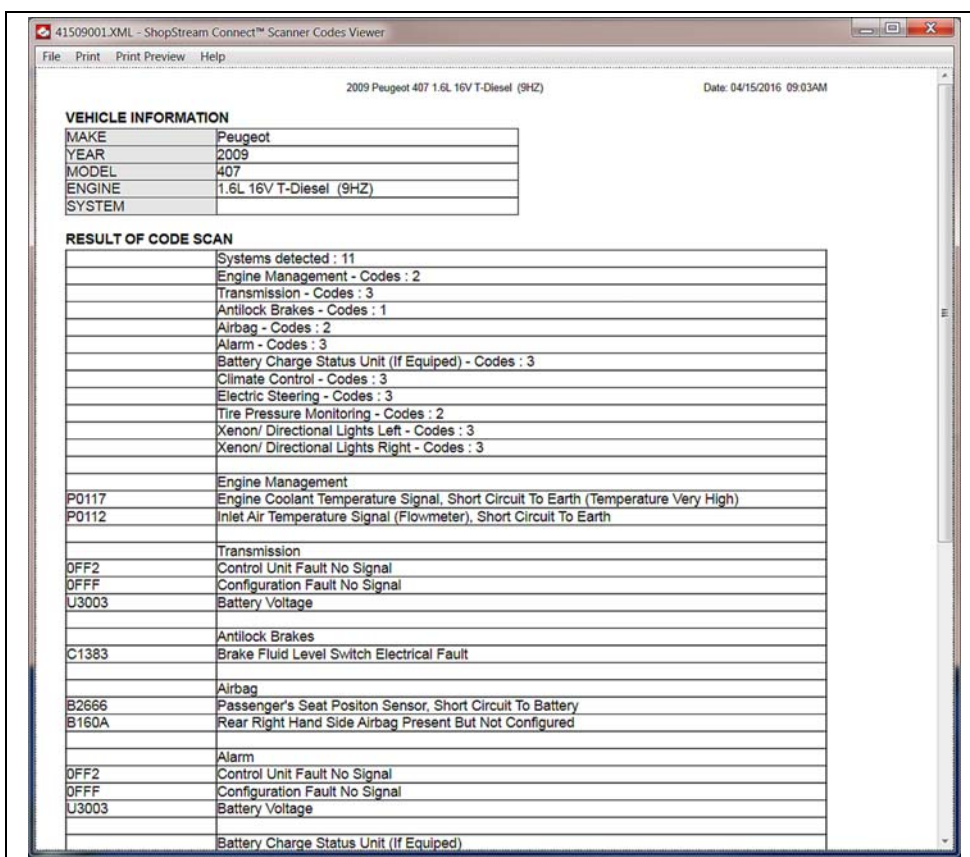



Figure 6-6 Typical Code Scan Report in Shopstream Connect

Depending on the vehicle, Code Scan (if supported) may be available from the Systems menu. Selecting **Code Scan** starts an active scan of vehicle control modules, and opens the Code Scan results screen (Figure 6-7). A progress indicator is shown at the top indicating the active scanning progress. Once completed, the results are displayed by system category.

The following Code Scan related control icons are used:

Icon	Function
	Refresh - Restarts the code scan
	System - Opens the main menu of the system selected

The following results are displayed progressively as the modules are scanned:

- **The total number of systems (modules) detected** (Figure 6-7).



Figure 6-7 Code Scan systems analyzed result total

- **A list of all the systems analyzed with DTCs totals.** A categorized system list with DTC totals is displayed in the order they are scanned. To view the main menu for a system in the list, select the system, then select the **System** icon (Figure 6-8).

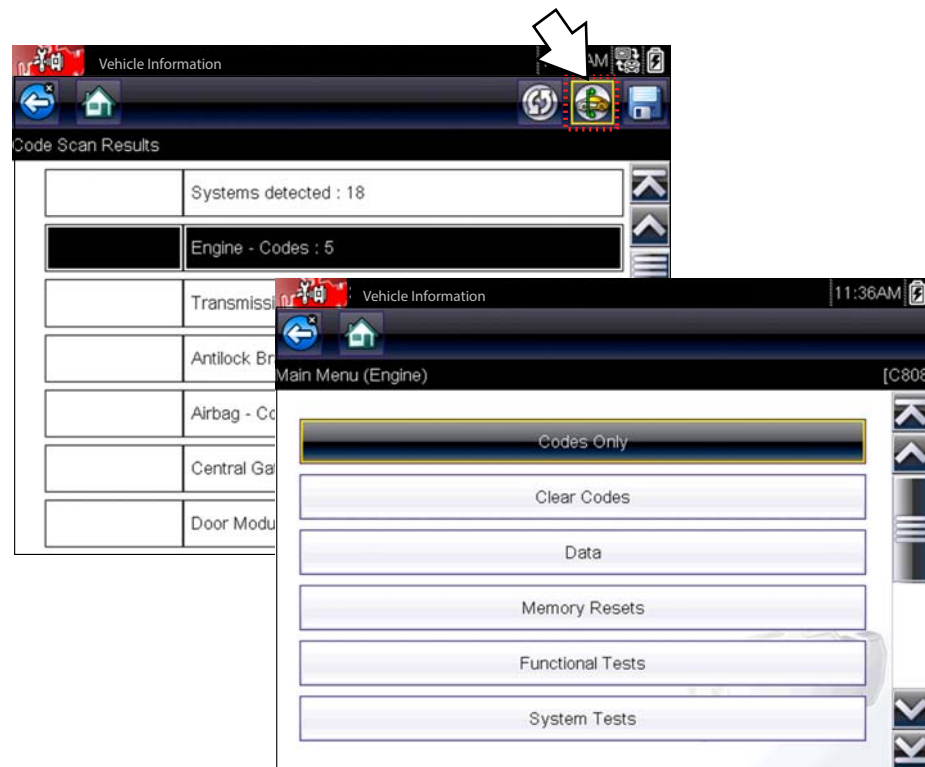

Figure 6-8 System icon (opens Main Menu)



NOTE:

Some 2005 to 2008 vehicles may not display global OBD-II information in the Code Scan list. A message will be displayed to inform you the OBD-II - codes and monitors for this vehicle may be accessed using the global OBD-II function. See [OBD-II/EOBD](#), on page 53.

Saving Codes, and Code Scan Results)

When using the code scan feature, or when viewing individual system codes (e.g. engine, transmission) selecting the **Save** icon from the toolbar saves the results as a data file.

The saved file(s) can be viewed using two methods:

- On the diagnostic tool - See [View Saved Data](#), on page 80.
- Using ShopStream Connect - See [ShopStream Connect](#), on page 106.

Printing the Code Scan Report

The vehicle system report can also be customized and printed using ShopStream Connect - See [Printing the Code Scan Report](#), on page 110.

Clear All Codes Read by Code Scan

Selecting **Clear All Codes Read by Code Scan** erases all DTCs from all vehicle system modules that were read by Code Scan.

**NOTE:**

Clear All Codes Read by Code Scan may not clear global OBD-II codes on some vehicles.

6.3.3 System Main Menu Options

Once a System is selected (e.g. Engine, Transmission, Antilock Brakes, etc), the diagnostic tool may establish communication with the vehicle, then display the System Main Menu (available tests).

**NOTE:**

Menus and navigation will vary by vehicle.

The System Main Menu may include:

- **Codes Menu**—displays diagnostic trouble code (DTC) records from the vehicle electronic control module. Selecting may open a submenu of viewing options.
- **Clear Codes**—erases DTC records and other data from the electronic control module (ECM). This selection is found on a Codes submenu for some models.
- **Data Display**— displays PID data from the vehicle ECM. Selecting may open a submenu of viewing options.
- **Functional Tests**—provides specific subsystem tests. The tests vary depending on the manufacturer and model.
- **Actuator Tests**—similar to functional tests, checks the operation of certain actuators, such as solenoid valves and relays.
- **Memory Resets**—allows you to reprogram adaptive values for certain components after making repairs. Selecting opens a submenu. These options are found on the Functional Tests Menu for some models.
- **System Tests**—provides specific subsystem testing. Performing these tests is similar to functional tests.
- **Generic Functions**—lets you access certain available Generic OBD II functions from a proprietary menu (1996 and newer vehicles only).

The following sections, describe some of the System Main Menu items listed above.

6.3.4 Codes Menu

This selection may appear as Codes, Codes Menu, Codes Only, Codes (No Data), Service Codes or something similar on the menu. Selecting opens a list of viewing options that includes:

- [Display Codes](#)
- [Clear Codes](#), on page 38
- [Freeze Frame/Failure Records](#), on page 39

Display Codes

This function opens either a list of diagnostic trouble codes (DTCs) stored in the selected vehicle electronic control module (ECM), or a submenu of DTC viewing options. The code list includes the DTC and a brief description ([Figure 6-9](#)).

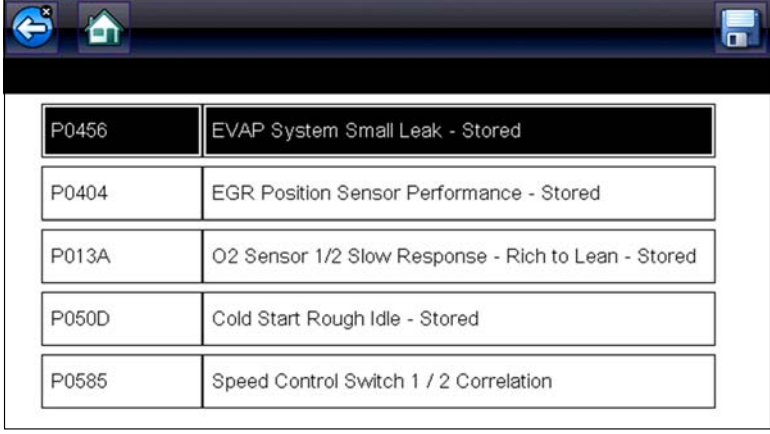

P0456	EVAP System Small Leak - Stored
P0404	EGR Position Sensor Performance - Stored
P013A	O2 Sensor 1/2 Slow Response - Rich to Lean - Stored
P050D	Cold Start Rough Idle - Stored
P0585	Speed Control Switch 1 / 2 Correlation

Figure 6-9 DTC results

Submenu options may include:

- **Trouble Code Information**—opens a list of codes in ECM memory
- **History Codes**—opens a list of codes whose symptoms are not currently present. History codes indicate an intermittently occurring problem.
- **Failed This Ignition**—opens a list of codes that set during the current ignition cycle.
- **MIL SVS or Message Requested**—displays ECM requests to turn on the malfunction indicator lamp (MIL) or service vehicle soon (SVS) lamp, or display a driver information alert.
- **Last Test Failed**—displays a complete list of failed tests.
- **Test Failed Since Code Cleared**—displays a list of tests that failed since the last time codes were cleared from ECM memory.

Clear Codes

The diagnostic tool clears codes from the vehicle electronic control module memory on most vehicles. If this function is not available on the test vehicle, Clear Codes does not appear as a menu option.



NOTE:

Clear Codes is also available from OBD-II Health Check (see [OBD Health Check](#), on page 54).



To clear codes:

1. Select **Clear Codes** from the Codes Menu.
A confirmation message displays.
2. Make sure any conditions shown on the confirmation message are met, then select **Yes**.
A “codes cleared” message displays once the operation is complete.
3. Select **Continue** to return to the Codes Menu.

IMPORTANT:

Clearing codes erases all temporary ECM information, including Freeze Frame/Failure Records. Make sure no vital diagnostic information will be lost before clearing codes.

Freeze Frame/Failure Records

This selection displays the DTC that was set, along with corresponding data, when the ECM commanded the malfunction indicator lamp (MIL) to turn on.

Data Display

Select **Data** to view PID data from the vehicle ECM. In data display mode the screen has a toolbar and a main body (Figure 6-10).

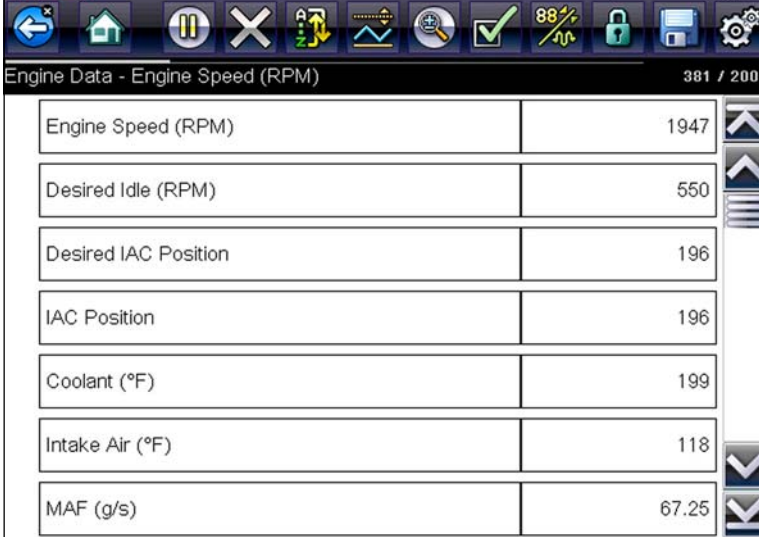

The screenshot shows a software interface for displaying engine data. At the top is a toolbar with various icons for navigation and control. Below the toolbar, the title bar reads "Engine Data - Engine Speed (RPM)" and "381 / 2000". The main content area is a table with two columns: parameter name and value. The parameters listed are Engine Speed (RPM), Desired Idle (RPM), Desired IAC Position, IAC Position, Coolant (°F), Intake Air (°F), and MAF (g/s). The values are 1947, 550, 196, 196, 199, 118, and 67.25 respectively. On the right side of the table, there are up and down arrow icons for scrolling through the list.

Parameter	Value
Engine Speed (RPM)	1947
Desired Idle (RPM)	550
Desired IAC Position	196
IAC Position	196
Coolant (°F)	199
Intake Air (°F)	118
MAF (g/s)	67.25

Figure 6-10 Data display screen

The toolbar control icons are described in [Scanner Control Icons](#), on page 29 and [Common Toolbar Control Icons](#), on page 17.

During data display the main body of the screen is divided into two columns; the left-hand column has a description of the parameter and the right-hand column shows the parameter value or state. Parameters are listed in the order in which they are transmitted by the ECM, so expect variations between years, makes, and models.

Up to three parameters can be locked, or fixed, at the top of the list. Locked parameters do not change as you scroll through the parameter list. The **Lock/Unlock** icon on the toolbar selects which parameters are fixed (see [Locking Parameters](#), on page 42).

Displayed data may also be paused or saved for detailed review and future reference, see [Saving Files](#), on page 45 and [Pausing and Reviewing Data Files](#), on page 39.

Pausing and Reviewing Data Files

During normal operation, data from the vehicle's ECM is continuously being stored in buffer memory as it is displayed onscreen. The Pause feature, allows you to temporarily pause data collection to review it in detail.



To pause and review data

Toolbar control icons are described in [Scanner Control Icons](#), on page 29 and [Common Toolbar Control Icons](#), on page 17.

1. While viewing data, select the **Pause** icon.

On the toolbar, the playback control icons are displayed. A counter displays along the right-hand edge of the screen between the toolbar and the main body. A bar graph to the left of the counter shows how much data is in the memory buffer. A slider on the bar graph indicates the position of the current screen in relation to the entire contents of the data buffer.

Use the slider to quickly scroll through the data. Use the control icons to accurately position the cursor. The cursor (vertical line), indicates your position when in the graph mode, appears once you begin navigating ([Figure 6-11](#)).

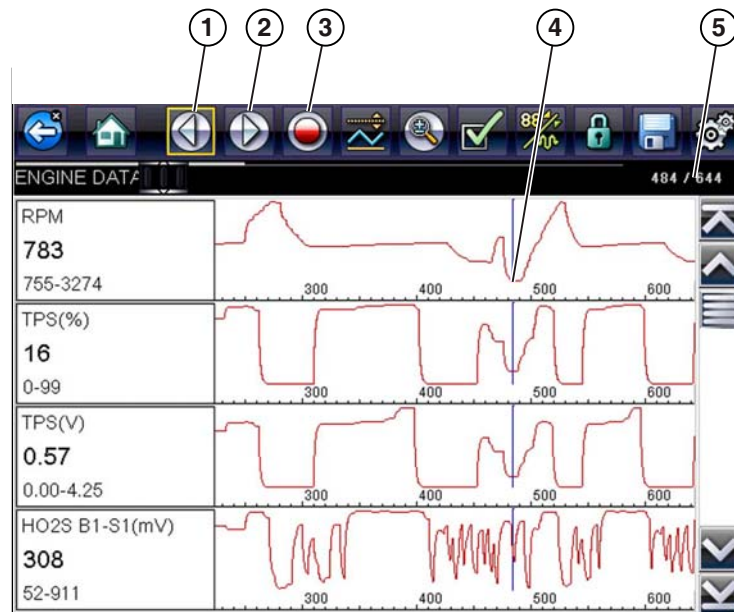

1— Step Back

2— Step Forward

3— Record

4— Cursor

5— Counter (current position / total)

Figure 6-11

2. Scroll up or down to review the list of data.
3. Select the desired control icon to move forward or back in the selected direction.



To resume:

- Select the **Record** icon.

The display changes back to display data and the **Pause** icon is shown on the toolbar. A vertical rule is displayed on the data graph to indicate data was paused at that point.



NOTE:

The **Shortcut** icon can be set to perform the Pause/Play function. See [Configure Shortcut Button](#), on page 85 for additional information.

Customizing the Data List



The **Custom Data List** icon on the toolbar is used to determine which specific parameters display. Minimizing the number of parameters on the data list allows you to focus on any suspicious or symptom-specific data parameters. You can add or remove most parameters from the list. Certain vital parameters may not be removed. These appear in gray at the top of the list along with a lock icon, and they cannot be selected.



NOTE:

Limiting the number of parameters that display to those that apply to a particular situation results in a faster data refresh rate, and reduces the amount of memory used for saved files.





To create a custom data list:

1. Select the **Custom Data List** icon on the toolbar.

The data selection screen displays and selection icons appear. Check marks to the left of the parameter description indicate which parameters are selected for display.

The toolbar icons provide options for selecting and deselecting parameters to include or remove from the custom data list:

Icon	Description
	Select/Deselect , hide or display individual parameters in the list.
	Select All/Deselect All , hide or display all parameters in the list.

2. Create a custom data list by selecting (check mark box by parameter name) the parameters to include.
3. Select **Back** to display the updated data list.

Changing Screen Views



Selecting the **View** icon opens a drop-down menu of options:

- PID List
- 1 Graph
- 2 Graph
- 4 Graph

The PID (parameter identification) List view is a 2-column display with the name of the parameters in the left column and their current values in the right column ([Figure 6-10](#)).

The 1, 2, and 4 Graph views divide the screen horizontally to simultaneously display data graphs for the indicated number of parameters ([Figure 6-12](#)). Use the scroll bar or the **up** (▲) and **down** (▼) icons to view other parameters in the list.

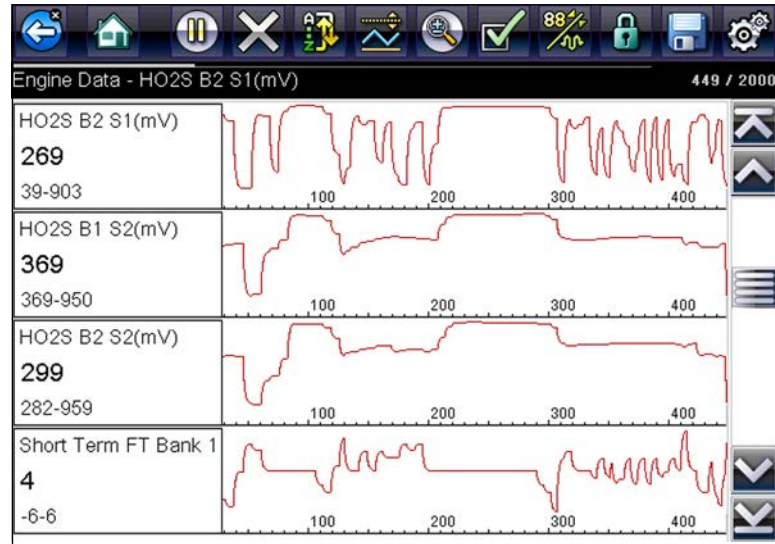

Figure 6-12 Four graph view

**NOTE:**

Any previously set conditions, such as sort order or locked data, remain in effect when the screen view is changed.

Locking Parameters



Use the **Lock/Unlock** icon to hold selected lines of the data in place and prevent them from scrolling, or to release previously locked lines of data. Up to three lines of data may be held at a time. This feature allows you to position related parameters together, making it easier to monitor their values and spot inconsistencies.

Locked parameters display as the top frames on the main body of the display screen, as well as at their usual position within the data list (Figure 6-13). A lock icon appears to the left of the parameter name to indicate it is locked.

**To lock parameters:**

1. Highlight the parameter to be locked.
2. Select the **Lock/Unlock** icon on the toolbar to lock it.

A copy of the locked parameter is now shown at the top of the data list, and a lock icon appears alongside the parameter name.

3. Highlight and select additional parameters to lock.

Up to three parameters can be locked at a time. Once locked, a parameter remains locked until it is manually unlocked, or communication with the vehicle is stopped.

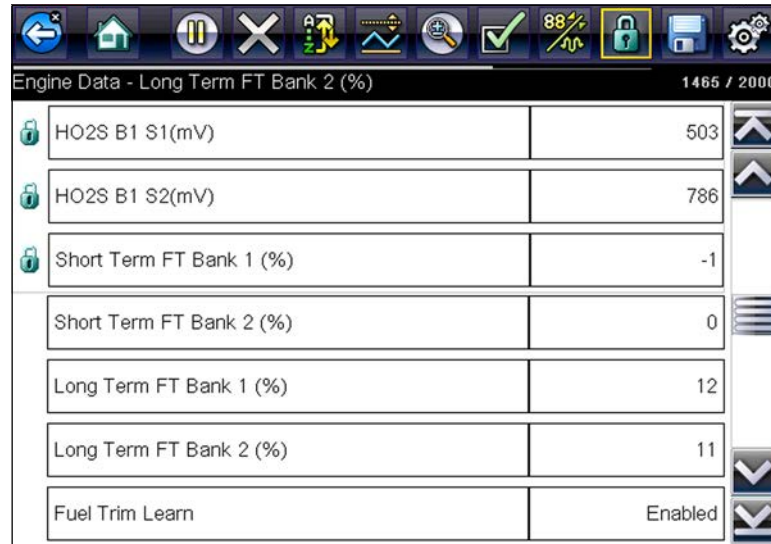

Parameter	Value
HO2S B1 S1(mV)	503
HO2S B1 S2(mV)	786
Short Term FT Bank 1 (%)	-1
Short Term FT Bank 2 (%)	0
Long Term FT Bank 1 (%)	12
Long Term FT Bank 2 (%)	11
Fuel Trim Learn	Enabled

Figure 6-13 Locked parameters

**NOTE:**

If three parameters are locked, one of them must first be unlocked before another parameter can be locked.

**To unlock parameters:**

1. Scroll through the data list and highlight the parameter to be unlocked, or released.
2. Select the **Lock/Unlock** icon on the toolbar.
The released parameter and the lock icon disappear from the top of the data list.
3. Repeat Step 1 and Step 2 to release other parameters if needed.

Setting Trigger Levels

The trigger icon allows you to configure the diagnostic tool to automatically save PID data from buffer memory to a file when a parameter value crosses a threshold. When a trigger is armed, if a trigger event (activated) occurs data collection is stopped and saved to a data file. After a trigger has been activated, it must be re-armed to collect additional data.

Selecting the **Trigger** icon opens a menu that includes:

- **Set Trigger**—establishes upper and lower signal values to initiate an event capture for the highlighted parameter.
- **Arm Trigger**—activates the diagnostic tool to capture an event when the signal crosses a threshold value.
Trigger lines change colors to indicate the trigger is armed.
- **Clear All Triggers**—deletes all previously set trigger levels.

If triggers are set the menu options are:

- **Clear Trigger**—deletes set trigger levels for the highlighted parameter.
- **Disarm Trigger**—de-activates event capture capability.
- **Clear All Triggers**—deletes all previously set trigger levels.

**To set trigger levels:**

1. Highlight the parameter to be used for triggering the recording.
2. Select the **Trigger** icon.
3. Select **Set Trigger** from the drop-down menu.

A graph of the highlighted parameter with a trigger toolbar above it fills the main body of the screen (Figure 6-14).

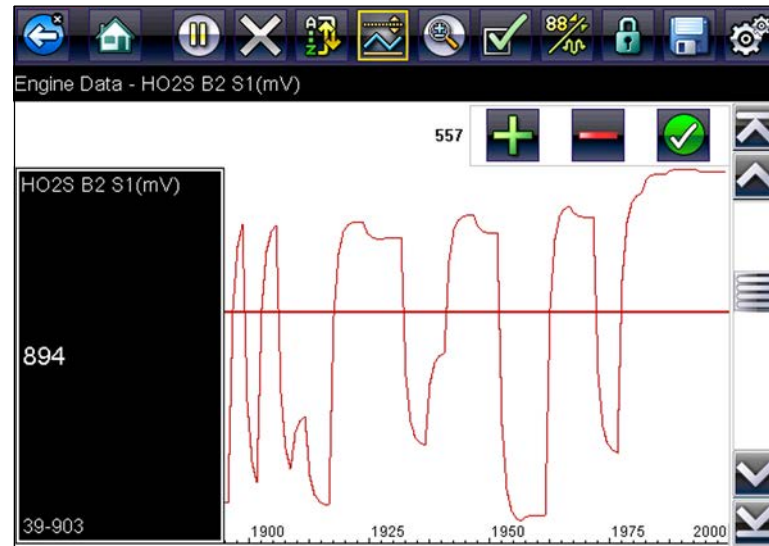

Figure 6-14 Trigger set screen

The trigger level line displays as a solid line running horizontally across the data graph. An upper and lower trigger level must be set, the upper level is set first.

4. Select the plus (+) and minus (-) icons on the toolbar, or use the up ▲ and down ▼ arrow buttons to position the upper trigger level to where you want it on the graph.
5. Select ✓ on the toolbar, or press the **Y/✓** button, to set the upper threshold.
A lower trigger level line now appears at the mid-point of the graph.
6. Select the plus (+) and minus (-) icons on the toolbar, or use the up ▲ and down ▼ arrow buttons to position the lower trigger level line to where you want it on the graph.
7. Select ✓ on the toolbar, or press the **Y/✓** button, to set the lower threshold.

The display returns to the PID data view and the trigger points appear as horizontal lines across the designated parameter graph. Repeat this procedure to establish trigger points for other parameters if desired. Once armed, any data points that register outside of your set conditions pause data collection and save data to a file.

**NOTE:**

Only three parameters can have trigger levels set at one time, but only one of the conditions needs to be satisfied for triggering to occur.

**To arm triggers:**

1. Select the **Trigger** icon on the toolbar.
2. Select **Arm Triggers** from the drop-down menu.

The trigger lines on the data graphs change color to indicate an armed condition.

Triggers for all of the graphs are armed simultaneously. Once triggering is armed, it remains in that state until you switch it off, or the trigger is activated. If trigger settings are modified or are added for other parameters, they are armed as soon as you exit the setting screen.

6.3.5 Saving Scanner / OBD-II/EOBD Data Files

The following procedures are used when saving and reviewing data files for Scanner and OBD-II/EOBD.

Saving Files

During normal operation, data from the vehicle's ECM is continuously being stored in buffer memory as it is displayed onscreen. Buffer memory is limited to a predetermined "total" size and is displayed on the counter (located below the toolbar on the right side of the screen) (Figure 6-11).

Selecting **Save** writes the stored buffer memory to a file. Saving data is useful when trying to isolate an intermittent problem or to verify a repair during a road test. The saved file can be played back (similar to a movie clip) by selecting **Previous Vehicles and Data > View Saved Data**. See [View Saved Data](#), on page 80 for additional information.



NOTE:

The **Save icon** performs the same function as "Save Movie" function choice for the programmable **Shortcut** button, see [Configure Shortcut Button](#), on page 85 for details.

The saved data file can also be viewed, printed, or transferred to a personal computer using ShopStream Connect. See [Connect-to-PC](#), on page 84, and [ShopStream Connect](#), on page 106 for additional information

The toolbar control icons are described in [Scanner Control Icons](#), on page 29 and [Common Toolbar Control Icons](#), on page 17.



To save data:

- Select **Save**.

A save dialog box displays while data is being saved. The data is saved when the message box disappears.

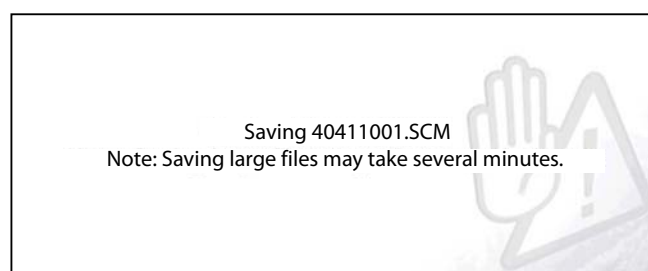

Figure 6-15 Save dialog box

Saving Screens

The **Shortcut** button can be programmed to save a snapshot of a visible screen as a bitmap file, see [Configure Shortcut Button](#), on page 85 for details. The saved file can be viewed by selecting

Previous Vehicles and Data > View Saved Data, see [View Saved Data](#), on page 80 for additional information.

6.3.6 Functional Tests

The **Functional Tests** selection is used to access vehicle-specific subsystem tests. Available tests vary by manufacturer, year, and model. Only the tests available for the identified vehicle display in the menu.

There are several types of functional tests:

- **Information Tests**—these are read-only tests, like selecting “VIN” from a Functional Tests menu to display the VIN of the identified vehicle.
- **Toggle Tests**—these tests switch a component, such as a solenoid, relay, or switch, between two operating states.
- **Variable Control Tests**—these tests command a certain value for a system or component, such as varying spark timing in 1° increments or EGR valve duty cycle in 10% increments.
- **Reset Tests**—these tests reset the adaptive, or learned, values that are stored in the vehicle electronic control module memory.
- **Scripted Tests**—these tests are software routines that place the vehicle into special operating modes for performing certain repairs, such as bleeding brakes with ABS.

Selecting Functional Tests opens a menu of test options that varies by make, year, and model. Selecting a menu option either activates the test or opens a submenu of additional choices. Follow all screen instructions while performing tests. How and what information is presented on the screen varies according to the type of test being performed and the vehicle being serviced.

Toggle and variable control tests often display functional test controls on the toolbar at the top of the screen with PID data in the main body ([Figure 6-16](#)).

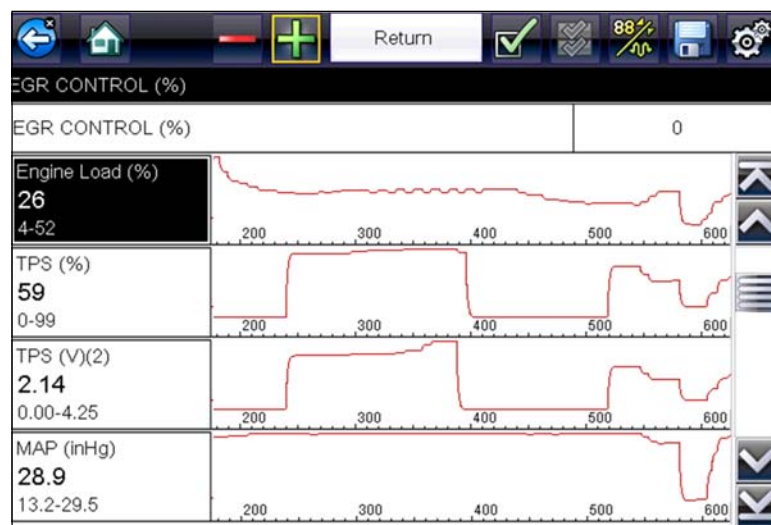

Figure 6-16 Functional test screen

A Test icon on the toolbar activates the test, and a Return, or similarly named, icon cancels the test. For variable control tests, the variable value displays between the main body and the toolbar. Plus and Minus icons on the toolbar increase and decrease the variable value.



A Data List icon, is available on the toolbar for some tests. This feature allows you to change which data list displays in the main body without exiting the functional test. The icon is only available when the test is inactive.

6.3.7 Generic Functions

Generic Functions are used to access generic OBD-II/EODB data on vehicles that support it. For additional information see [OBD-II/EODB](#), on page 53.

6.4 Exiting Scanner

The Scanner function remains open as long as there is an active communication link with the vehicle. You must interrupt this communication link in order to exit from tests and power down the diagnostic tool. A warning message displays if you attempt to shut down while the diagnostic tool is communicating with the vehicle.

NOTE:

Damage to the vehicle electronic control module (ECM) may occur if communication is disrupted. Make sure the data cable is properly connected at all times during testing. Exit all tests before disconnecting the data cable or powering down the diagnostic tool.

**To exit the Scanner function:**

1. From any active data screen, select the **Back** icon on the toolbar.
The “stopping communications” message briefly displays followed by the Data menu.
2. From the Data Menu, select **Back** on the toolbar.
The “stopping communications” message displays again, then the Main menu. Once the Main menu is displayed, communication has been terminated and it is safe to return to the Home screen and power down the diagnostic tool.

This section describes basic Scanner functions including data cable connection, and how to display diagnostic trouble codes for motorcycle applications. Many of the Scanner functions are similar or identical in operation as the automotive Scanner, for Scanner operations not listed in this section see [Scanner - Automotive](#), on page 27.



The **Scanner** icon is located on the Home screen.

The Scanner function allows your diagnostic tool to communicate with the control modules of the motorcycle being serviced. This allows you to perform tests, view diagnostic trouble codes (DTCs), and live data parameters from various vehicle systems such as the engine, antilock brakes (ABS), body control module and more.

7.1 Basic Operation

7.1.1 Basic Scanner Operation (Quick Start)

This section lists the basic scanner operation steps, and is only intended as a quick-start reference. Refer to the supporting topics in this section for detailed operation information.



Getting Started (Basic Steps)

Menus, options and procedures will vary across motorcycle manufacturers and models.

1. Select **Scanner** from the Home screen.
2. Select **Motorcycle**.
3. Follow the prompts to identify the motorcycle (e.g. make, year, model), then select **OK** to confirm.
4. Follow the onscreen instructions to connect the **DA-5** data cable and **Smart Vehicle Interface (SVI)** to the motorcycle diagnostic connector. See [Data Cable Connection](#), on page 49.
5. Turn the ignition on and move the “run” switch to on, or start the engine.

Ensure the LEDs on the SVI and DA-5 cables are on when establishing communication between the motorcycle and diagnostic tool.

6. Follow the prompts to select a **System** (e.g. Engine, ABS, Radio).
7. Select a **Function/Test** (e.g. Codes Menu, Code Scan, Data Display, Functional Tests). See [System Main Menu Options](#), on page 37.

7.1.2 Data Cable Connection

On-screen data cable connection instructions are provided.

As an example, [Figure 7-1](#) shows a typical data cable connection using the supplied DA-5 data cable and the Harley-Davidson HAR-2 Smart Vehicle Interface (SVI), other manufacturers are similar.

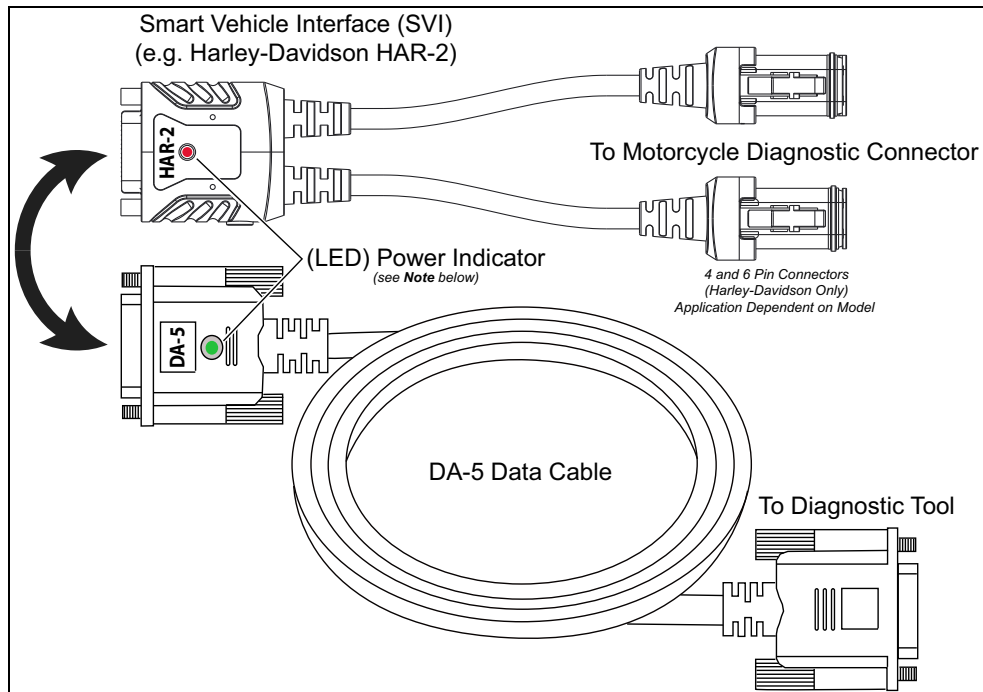

Figure 7-1

Contact your sales representative to purchase additional Smart Vehicle Adapters (SVIs) for other Motorcycle manufacturers.

1. Follow the onscreen instructions to connect the **Smart Vehicle Interface (SVI)** to the motorcycle diagnostic connector.

The SVI requires 12VDC power to communicate. Power is normally supplied through the motorcycle diagnostic connector, however the supplied 12VDC power accessory cable (not shown) can be used when power is needed. When the LED is on, the SVI is being powered.

2. Connect the **DA-5** data cable to the SVI and diagnostic tool.

Ensure the LEDs on the SVI and DA-5 cables are on when establishing communication between the motorcycle and diagnostic tool.

7.1.3 Vehicle Identification / System Selection

The motorcycle must be correctly identified for the diagnostic tool to communicate, and display data correctly. Menus and navigation will vary by make and model.

Depending on the motorcycle, the identification process may require manual entry of the motorcycle information, or it may be automated. The following Scanner functions are available to identify the motorcycle:

Auto ID - Automatically completes the identification process after the motorcycle make and year are manually entered.

Manual ID - Allows for manual entry of all required motorcycle identification criteria.



Use the following procedure to identify a motorcycle.

The following procedure applies to most motorcycles, and may vary depending on the motorcycle. Not all motorcycles support the Auto ID feature.

1. Select **Scanner** from the Home screen.
2. Select **Motorcycle**.
3. Follow the prompts to identify the motorcycle (e.g. make, year, model).

A menu option may be displayed to choose either **Automatic ID** or **Manual ID**.

- Selecting **Automatic ID** (If supported) will briefly display a communications screen informing you that the diagnostic tool is attempting to establish communication and determine vehicle identification.

Once the vehicle has been identified, the vehicle confirmation screen displays. If the vehicle information is correct, select **OK** to continue, then proceed to step 3.

If the vehicle does not support Auto ID, the diagnostic tool will attempt to identify the vehicle and then display a message indicating that vehicle identification cannot be made. If this occurs, proceed to "**Selecting Manual ID**" next.

- Selecting **Manual ID** allows you to manually enter all the vehicle information to identify the vehicle.
Follow the screen prompts to enter all the information required to identify the vehicle. Once the vehicle has been identified, the vehicle confirmation screen displays (Figure 7-2). If the vehicle information is correct, select **OK** to continue, then proceed to step 3.

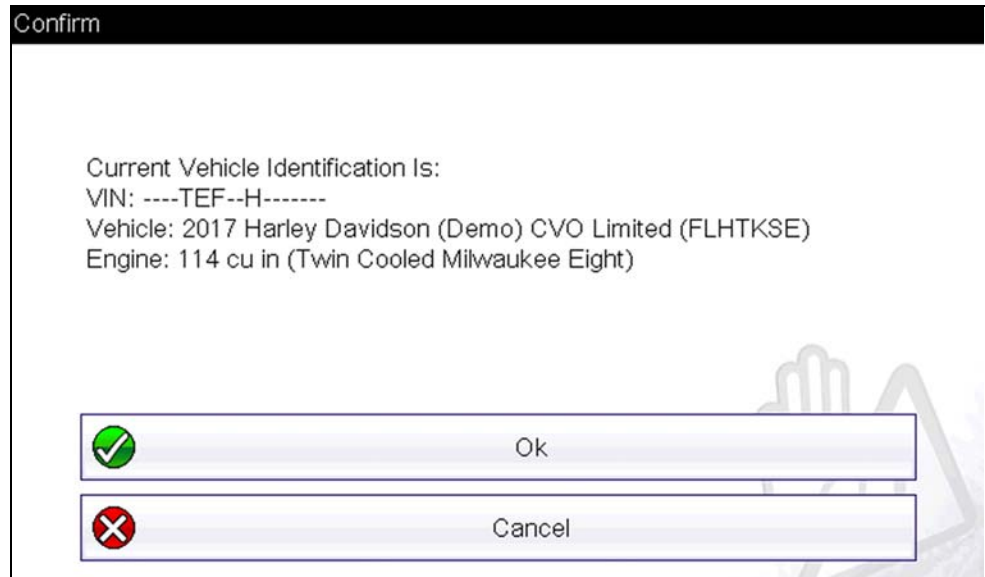

Figure 7-2 confirmation screen

After the motorcycle is identified, prompts will indicate to turn the motorcycle ignition on and connect the data cable.

Depending on the motorcycle, a menu option to select a system list display type may be provided.

Some motorcycles may support a “Fitted Systems” display type. In this situation a menu option is provided to display the fitted systems or all systems. Selecting Fitted Systems will only display systems that the diagnostic tool is communicating with. Selecting All Systems will display every system possibly supported.



NOTE:

In situations where fitted systems cannot be identified, all possible systems will be listed, however this does not indicate that all systems are present or supported.

A menu of available systems and/or options is displayed. Select a system or option (Figure 7-3) to continue.

By default, System options are displayed by category (e.g. Audio/Video, Body Controls, Instruments, etc.). In this mode commonly used selections are at the top of the list.

Depending on your preference, select the icon (arrow in Figure 7-3) to toggle the display between a categorized (Figure 7-3) and non-categorized (Figure 7-4) list.

4. When a system (e.g. Engine, Antilock Brakes, etc) is selected, the diagnostic tool will attempt to establish communication with that motorcycle system, then (once connected) will display that system’s main menu, see [System Main Menu Options](#), on page 37.

For Code Scan information, see [Code Scan](#), on page 34.



Figure 7-3 Typical systems menu (categorized list view)

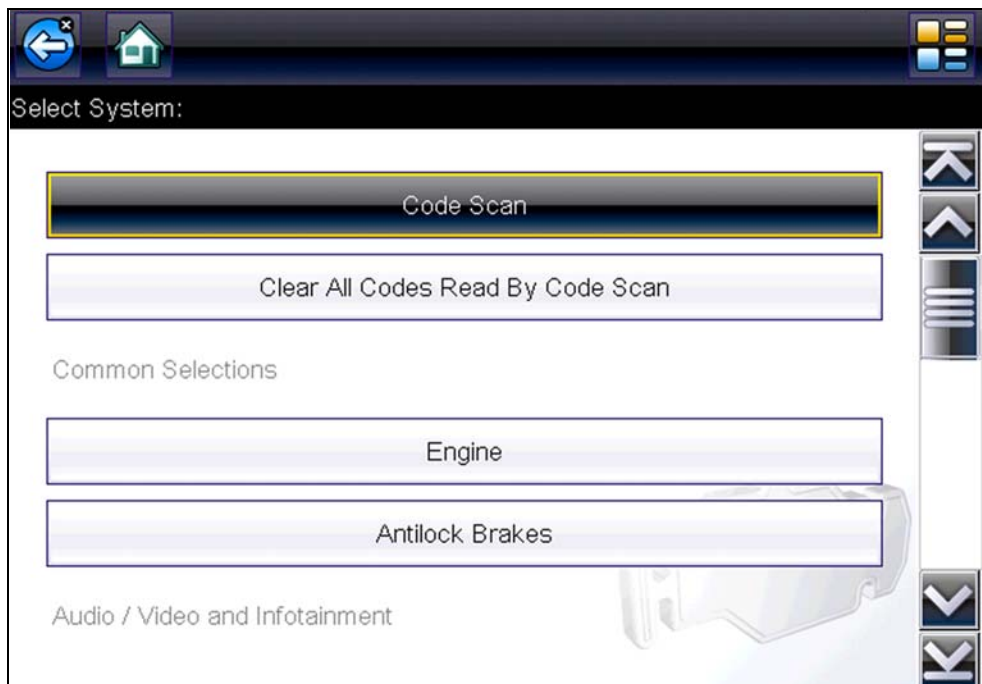

Figure 7-4 Typical systems menu (non-categorized list view)

This chapter describes the basic operation of the OBD-II/EOBD function.



The **OBD-II/EOBD** icon is located on the Home screen.

The OBD-II/EOBD function allows you to access “generic” OBD-II/EOBD data. Generic OBD-II/EOBD data is data limited to emission related diagnostics such as:

- Checking for emissions-related diagnostic trouble codes (DTCs)
- Checking the cause of an illuminated malfunction indicator lamp (MIL)
- Checking monitor status prior to emissions certification testing

To access other available electronic control module (ECM) data for vehicle specific systems, parameters or enhanced diagnostics use the Scanner function, see [Scanner - Automotive](#), on page 27,.



NOTE:

The OBD-II/EOBD function can also be used to access “generic” OBD-II/EOBD data for OBD-II/EOBD compliant vehicles that are not included in the Scanner function databases.

8.1 Basic Operations

8.1.1 Screen Layout and Toolbar Controls

Screen layout and toolbar controls are similar to the Scanner function, see [Screen Layout and Toolbar Icons](#), on page 28,.

8.1.2 Connecting the Data Cable

Connection of the data cable to the diagnostic tool and vehicle DLC is required for OBD-II/EOBD testing, see [Data Cable Connection \(Automotive\)](#), on page 19,.

8.1.3 Saving and Reviewing Data Files

Save and Pause control icon operation and data review procedures are the same as used for the Scanner function, see [Saving Scanner / OBD-II/EOBD Data Files](#), on page 45,.

8.2 OBD-II/EOBD Menu

8.2.1 OBD Health Check

The OBD-II Health Check offers a way to quickly check for and clear emissions-related diagnostic trouble codes (DTCs), and to check readiness monitors for emissions testing. Selecting opens the Health Check main menu (Figure 8-1). Make a selection to continue.

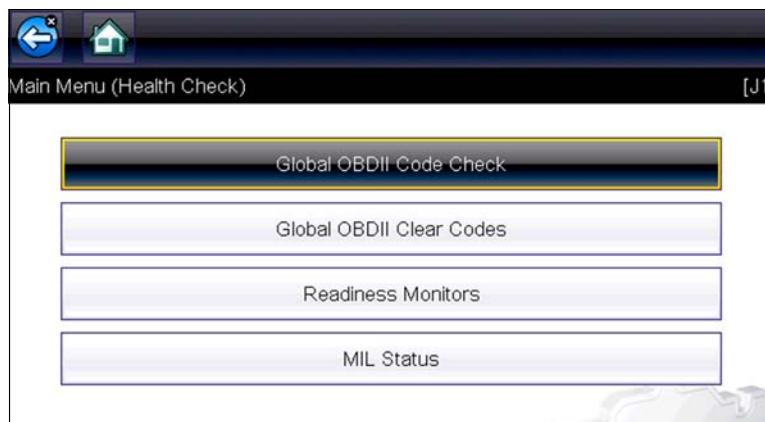

Figure 8-1 OBD Health Check menu

Global OBD II Code Check

Global OBDII Code Check displays stored emission related generic DTCs reported by the ECM. Selecting opens a submenu with two choices: Codes and Pending Codes. Either option opens a code list (Figure 8-2).

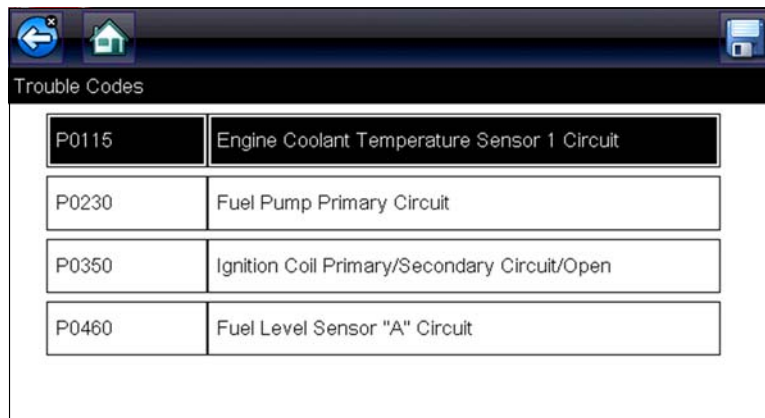

Figure 8-2 Code list

Codes

The Codes option displays a list of current emission related DTCs.

OBD-II/EOBD Codes have a priority according to their emission severity. The priority of the code determines the illumination of the MIL and the code erase procedure. Vehicle manufacturers have implemented the ranking differently, so there are differences between makes.

Pending Codes

The purpose of this service is to enable the diagnostic tool to obtain “pending” or maturing diagnostic trouble codes. These are codes whose setting conditions were met during the last drive cycle, but need to be met on two or more consecutive drive cycles before the DTC actually sets.



NOTE:

Save valuable time by using this service to verify test results after a single drive cycle following a vehicle repair and code clearing procedure.

- If a test failed during the drive cycle, the DTC associated with that test is reported. If the pending fault does not occur again within 40 to 80 warm-up cycles, the fault is automatically cleared from memory.
- Test results reported by this service do not necessarily indicate a faulty component or system. If test results indicate another failure after additional driving, then a DTC is set to indicate a faulty component or system, and the MIL is illuminated.

Global OBD II Clear Codes

This option is used to clear all emission related diagnostic data, such as DTCs, freeze frame data, and test results, from the memory of the selected ECM. Although OBD-II/EOBD displays generic OBD-II/EOBD data only, clearing codes erases all of the stored data, including any enhanced codes and freeze frame information.

A confirmation screen displays when the clear codes option is selected to prevent accidental loss of data. Select to continue from the confirmation screen.

Readiness Monitors

This test checks the status of the readiness monitoring system. An OBD-II /EOBD control system runs continuous and periodic tests to check the status of emission-related subsystems to gauge the integrity of the electronic operations. Two options are available for Readiness Monitors:

- **Monitors Complete Since DTC Cleared**—displays the status of all monitors that have run since the last time ECM memory was erased.
- **Monitors Complete This Cycle**—displays the status of the monitors that ran during the current drive cycle only.

Select either option and test results are shown in the data viewer (Figure 8-3).

ID : \$	E8
✓ MISFIRE	TEST COMPLETE
✓ FUEL SYSTEM	TEST COMPLETE
✓ COMPONENTS	TEST COMPLETE
– CATALYST	NOT COMPLETE
✗ HEATED CATALYST	NOT SUPPORTED
– EVAPORATIVE SYSTEM	NOT COMPLETE
✗ SEC. AIR SYSTEM	NOT SUPPORTED

Figure 8-3 Readiness monitor test report

Scroll to view the entire list of Readiness Monitors to ensure that all tests are complete. Select **Save** from the toolbar and follow the screen prompts to save a copy of the monitor report as part of the vehicle records.

MIL Status

This test checks the ECM commanded state (on or off) if the malfunction indicator lamp.

8.2.2 OBD Direct

OBD Direct includes the following menu and submenu choices:

- **OBD Diagnose**
 - **Start Communication** - initiates a test session
 - **Connector Information** - provides DLC location details
 - **Manual Protocol Selection** - provides choices for communication protocol
- **OBD Training Mode** - allows you to familiarize yourself with the capabilities of OBD-II/EOBD while navigating through menus without being connected to a vehicle.

Start Communication

Use the following procedure to begin an OBD-II/EOBD test session:



To perform an OBD-II/EOBD Test:

1. Connect the data cable to the test vehicle.
2. Select **Start Communications** from the OBD-II/EOBD menu.

A series of messages are displayed indicating automatic detection of vehicle type (12 or 24 V) has occurred and then the detected controllers are displayed.

The diagnostic tool establishes a communication link with the test vehicle, then opens an information screen (Figure 8-4).

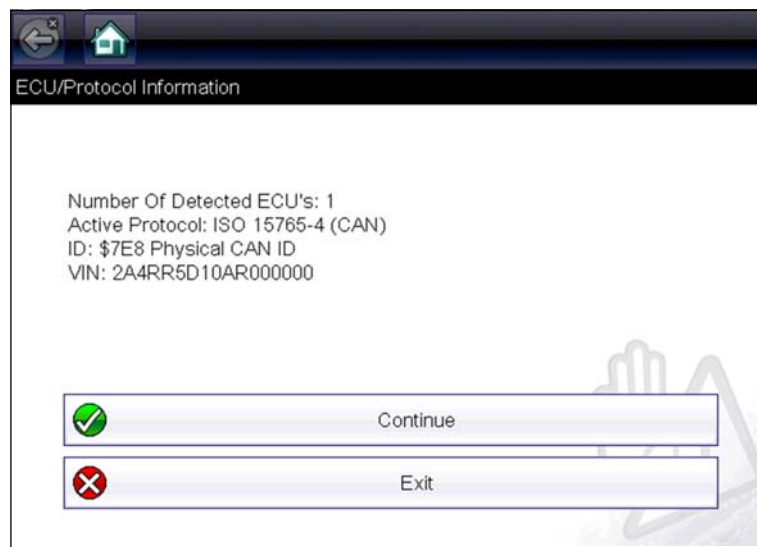

Figure 8-4

The information screen shows how many control modules were detected, which ECM is communicating, and which communication protocol is being used.

3. Select **Continue**.

A Select Service menu of available tests opens:

- [Readiness Monitors](#), on page 59,
- [MIL Status](#), on page 59,
- [\(\\$01\) Display Current Data](#), on page 60,
- [\(\\$02\) Display Freeze Frame Data](#), on page 60,
- [\(\\$03\) Display Trouble Codes](#), on page 60,
- [\(\\$04\) Clear Emissions Related Data](#), on page 60,
- [\(\\$05, 06, 07\) Display Test param./Results](#), on page 61,
- [\(\\$08\) Request Control of On-board System](#), on page 62,
- [\(\\$09\) Read Vehicle Identification](#), on page 62,
- [\(\\$09\) In-use Performance Tracking](#), on page 62,
- [\(\\$0A\) Emission Related DTC with Permanent Status](#), on page 62,

IMPORTANT:

All service modes are not supported by all vehicles, so the available menu selections will vary.

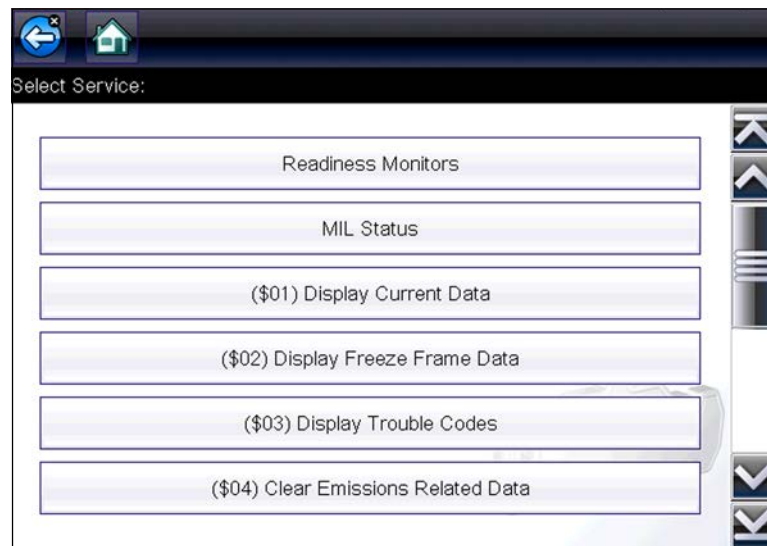

Figure 8-5 Service mode menu

4. Select a test to continue.

Readiness Monitors

Use this menu item to check the readiness of the monitoring system. Monitors not supported will display “not supported”. Scroll, if needed, to view the entire list of monitors (Figure 8-5). Selecting Readiness Monitors opens a submenu with two choices:

- **Monitors Complete Since DTC Cleared**—displays the results of all monitor tests that have run since the last time the vehicle electronic control module (ECM) memory was cleared.
- **Monitors Complete This Cycle**—displays only the results of monitor tests that ran during the current drive cycle, they reset when the ignition is switched off.

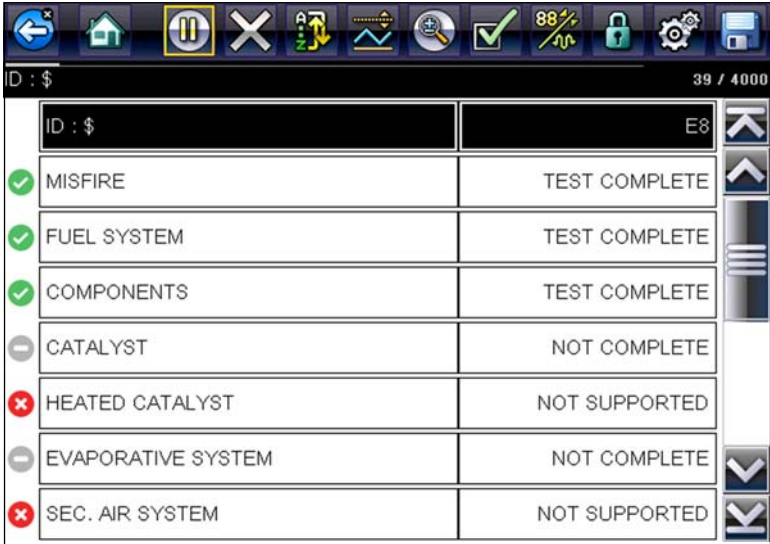

ID : \$		E8
✓ MISFIRE		TEST COMPLETE
✓ FUEL SYSTEM		TEST COMPLETE
✓ COMPONENTS		TEST COMPLETE
– CATALYST		NOT COMPLETE
✗ HEATED CATALYST		NOT SUPPORTED
– EVAPORATIVE SYSTEM		NOT COMPLETE
✗ SEC. AIR SYSTEM		NOT SUPPORTED

Figure 8-6

MIL Status

This item is used to check the current condition of the malfunction indicator lamp (MIL). Additional information, such as which ECM commanded the MIL on and the distance driven while the MIL is on (if supported), can also be displayed. The MIL Status report can also be saved as part of the vehicle records.

(\$01) Display Current Data

Use this test to display the serial data transmitted by the selected vehicle electronic control module (ECM). The main body of the screen has two columns; the left-hand column is a description of the parameter and the right-hand column is the parameter value or state. Viewing options and operations are the same as the Scanner function, see [Data Display](#), on page 39, for more information.



ID : \$	E8
ENGINE SPEED(1/min)	2539
ABSOLUTE THROTTLE POSITION(%)	17.6
ABSOLUTE THROTTLE POSITION B(%)	17.6
RELATIVE THROTTLE POSITION(%)	7.5
COMMANDED THROTTLE ACT .CONTROL(%)	7.5
ACCELERATOR PEDAL POSITION D(%)	16.5
ACCELERATOR PEDAL POSITION E(%)	7.8

Figure 8-7 Current data display

(\$02) Display Freeze Frame Data

Freeze frame data provides a “snapshot” of critical parameter values at the time a DTC set.

This item is used to display freeze frame data for any stored emission related diagnostic trouble codes (DTCs). In most cases the stored frame is the last DTC that occurred. Certain DTCs, those that have a greater impact on vehicle emissions, have a higher priority. In these cases, the highest priority DTC is the one for which the freeze frame records are retained.

(\$03) Display Trouble Codes

This is used to display any stored emission related DTCs reported by the ECM. The display is similar to the Scanner function code display (see [Display Codes](#), on page 37, for details). The list does not include enhanced DTCs in this mode.

(\$04) Clear Emissions Related Data

This item is used to clear all emission related diagnostic data, such as DTCs, freeze frame data, and test results, from the memory of the selected ECM.



To clear emission related Data:

1. Select **Clear Emissions Related Data** from the menu.
A confirmation message displays to help prevent loss of any vital data (Figure 8-8).

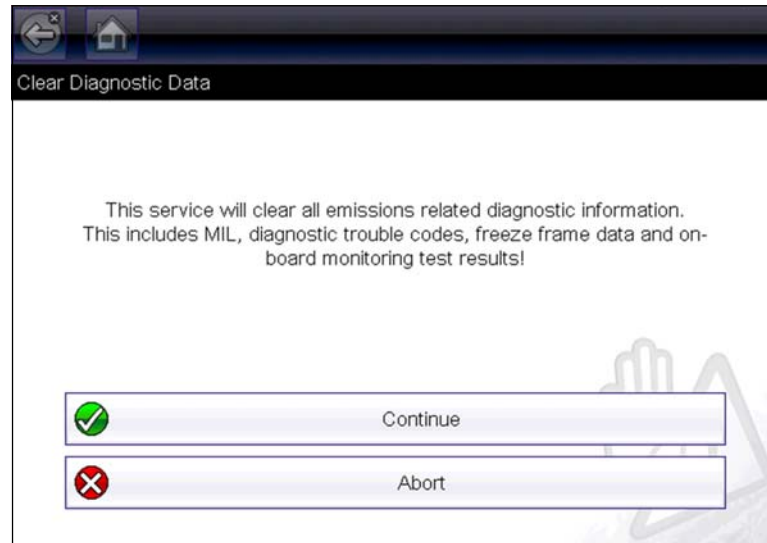

Figure 8-8 Clear codes confirmation message

2. Continue from the confirmation message.
The screen updates several times as ECM memory is erased, then a “data has been cleared” message displays.
3. Select **Continue** to return to the Select Service menu.

(\$05, 06, 07) Display Test param./Results

This option opens a submenu of parameters and test results from various sensors, monitor test results, and a record of DTC setting conditions detected during the last drive cycle. The submenu includes:

- [\(\\$05\) Oxygen Sensor Monitoring](#)
- [\(\\$06\) On-board Monitored Systems](#)
- [\(\\$07\) DTCs Detected During Last Drive](#)

(\$05) Oxygen Sensor Monitoring

This option opens a menu of tests available for checking the integrity of the oxygen (O₂) sensors. Making a selection displays all of the pertinent O₂ sensor parameters for the specific test. The test identification (ID) displays at the top of the data list.

(\$06) On-board Monitored Systems

This option opens a menu of tests from the monitored systems. The available data is for specific systems and components that the on-board diagnostic system monitors continuously, such as misfire, or non-continuously, such as the catalyst system. Making a menu selection displays the test results.

(\$07) DTCs Detected During Last Drive

This test opens a record of any DTCs that set during the last completed drive cycle. Select to open the DTC list.

(\$08) Request Control of On-board System

This service enables bidirectional control of the ECM. This service allows the diagnostic tool to control the operation of an on-board system, test, or component.

(\$09) Read Vehicle Identification

The purpose of this service is to enable the diagnostic tool to request and display vehicle-specific information, such as the vehicle identification number (VIN), the calibration identification, and the calibration verification number (CVN), of the test vehicle. Select a menu item to retrieve the information. Select **Return** to go back to the menu.

(\$09) In-use Performance Tracking

This option displays the “In-use Performance Tracking” of data. It is a record of the number of times each of the monitor tests have been completed. Select **Return** to go back to the menu.

(\$0A) Emission Related DTC with Permanent Status

This option displays a record of any “permanent” codes. A permanent status DTC is one that was severe enough to illuminate the MIL at some point, but the MIL may not be on at the present time.

Whether the MIL was switched off by clearing codes or because the setting conditions did not repeat after a specified number of drive cycles, a record of the DTC is retained by the ECM. Permanent status codes automatically clear after repairs have been made and the related system monitor runs successfully.

Connector Information

This option opens a database of vehicle diagnostic connector locations that includes most makes and models. The menu driven interface leads you quickly to difficult to find test connectors.

**To locate a vehicle diagnostic connector:**

1. Select **Connector Information** from the System menu.
A list of vehicle manufacturers displays.
2. Select a manufacturer from the list.
A list of models available from the selected manufacturer displays.
3. Select a model from the list.
If a cable adapter is needed, which one and how to connect it displays.
4. Select **Continue**.
Information on where to locate the vehicle diagnostic connector displays.
5. Select **Continue** to return to the System menu.

Manual Protocol Selection

Communication protocol is a standardized way of transferring data between an ECM and a diagnostic tool. Global OBD may use the following communication protocols:

- ISO 15765-4 (CAN)
- ISO 27145 (WWHOBD CAN)
- ISO J1939 (CAN)
- ISO 9141-2 (K-LINE)
- SAE J1850 PWM (Pulse Width Modulation)
- SAE J1850 VPW (Variable Pulse Width)
- ISO 14230-4 (Keyword Protocol 2000)
- SAE J2284/ISO 15765-4 (CAN)

When initially attempting to establish communication with the ECM the diagnostic tool attempts to communicate trying each protocol in order to determine which one is being used. During normal operation the communication protocol is automatically detected. If automatic detection fails, communication protocol can be manually selected.

IMPORTANT:

Using unsupported OBD communication protocols may activate warning lights and can set network related faults. Only use the manual selection option when OBD protocol is already known.

Select **Manual Protocol Selection** to open a menu of options (Figure 8-9).

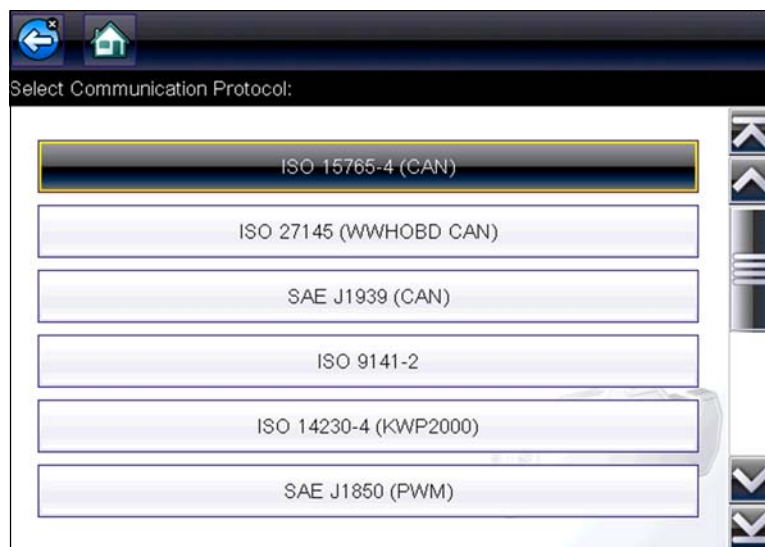

Figure 8-9 Manual protocol selection menu

Select the **Back** icon or press the **N/X** button to return to the OBD-II/EOBD Main menu.



This chapter describes the basic operation, and navigation of the **Quick Lookups** function. The **Quick Lookups** icon is located on the Home screen.

Quick Lookups includes Oil Specs and Resets and Tire and Wheel Service vehicle information functions:

9.1 Oil Specs and Resets

Oil Specs and Resets is located in the Quick Lookups main menu (**Quick Lookups > Oil Specs and Resets**).

Oil Specs and Resets provides OEM information on your diagnostic tool, via wireless network connection with our Snap-on Information Service. This feature allows you quick access to the following information:

- **Fluid capacity and specifications**
- **Scanner functional resets**
- **Service reset procedures and information**



NOTES:

- Oil Specs and Resets vehicle coverage is the same as the Scanner vehicle coverage.
 - Not all vehicles may have on-board diagnostic tool reset capabilities, or have information available.
 - The diagnostic tool is equipped with the ability to connect to a Wi-Fi network, however the connection is solely dedicated to our Snap-on Information Service. Before you begin using this function you must connect to a wireless network and turn the Wi-Fi radio on. See [Wi-Fi Connection / Troubleshooting](#), on page 98 for instructions.
 - If you experience a wireless network connection loss, Oil Specs and Resets information will not refresh and/or may cause the function to stop. To continue use, you must re-establish your Internet connection.
 - Performance may vary depending on your wireless network equipment and ISP.
-

9.1.1 Operation

**NOTE:**

The information and procedures provided by the Oil Specs and Resets function is vehicle specific, therefore a vehicle must be identified before information can be displayed.

**Using the Oil Specs and Resets function**

There are two methods to access this function:

- **From the Home screen** - select the **Quick Lookups** icon, then select **Oil Specs and Resets** (Figure 9-1), and then proceed to Step 1 below.



Figure 9-1 Oil Specs and Resets

- **From within a current Scanner session** - select **Oil Specs and Resets** from the System menu (Figure 9-2), then proceed to Step 3 below.

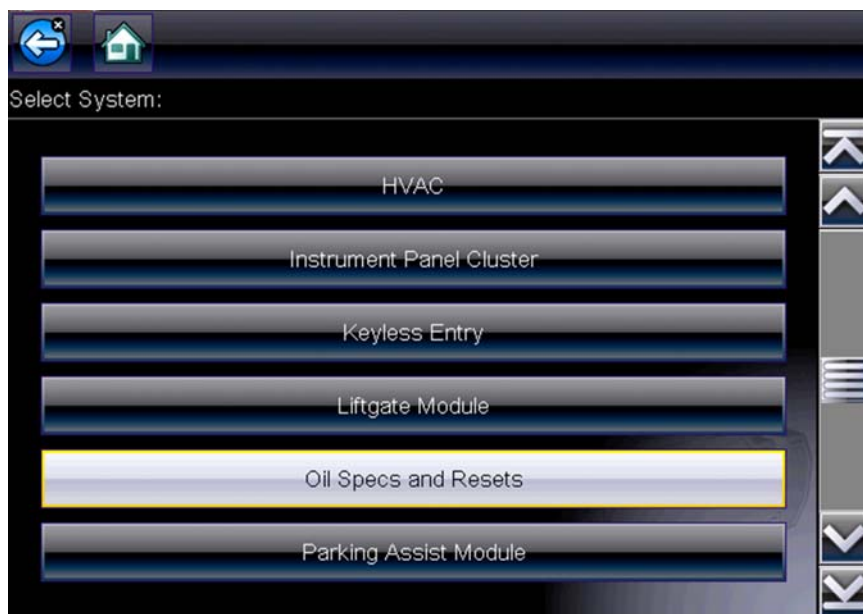

Figure 9-2 Scanner System Menu - Oil Specs and Resets Option

1. Follow the screen prompts to select the vehicle, Manufacturer, Year and Model.
2. Select **OK** to confirm the vehicle.



3. After the Fluid Capacity screen displays, navigate to either of the following options:
 - Perform a service interval reset using the diagnostic tool.
 - View OEM service reset instructions and related information.

**NOTE:**

Depending on the active function, descriptive information is displayed in the main body of the screen. If applicable, use the scroll bar or directional buttons (▲, ▼) to scroll up/down to view all of the information.

Icons

The following provides a brief description of the related Oil Specs and Resets toolbar icon functions. Detailed descriptions are provided in the following sections.

Icon	Icon Name	Description
	Fluid Capacity	Displays OEM recommended engine oil specification and capacity information.
	Functional Reset (Scanner)	Opens the Scanner service reset menu for the selected vehicle, providing options for available resets using the diagnostic tool.
	Reset Procedure	Displays OEM service interval reset instructions, to perform a manual reset of the service indicator.

Fluid Capacity

Selecting **Fluid Capacity** displays OEM recommended fluid specifications ([Figure 9-3](#)).

**NOTE:**

The Fluid Capacity screen is the default screen.

Typical information may include:

- Vehicle engine information
- Oil capacity specifications with or without oil filter
- Oil rating, weight and type
- Special notes

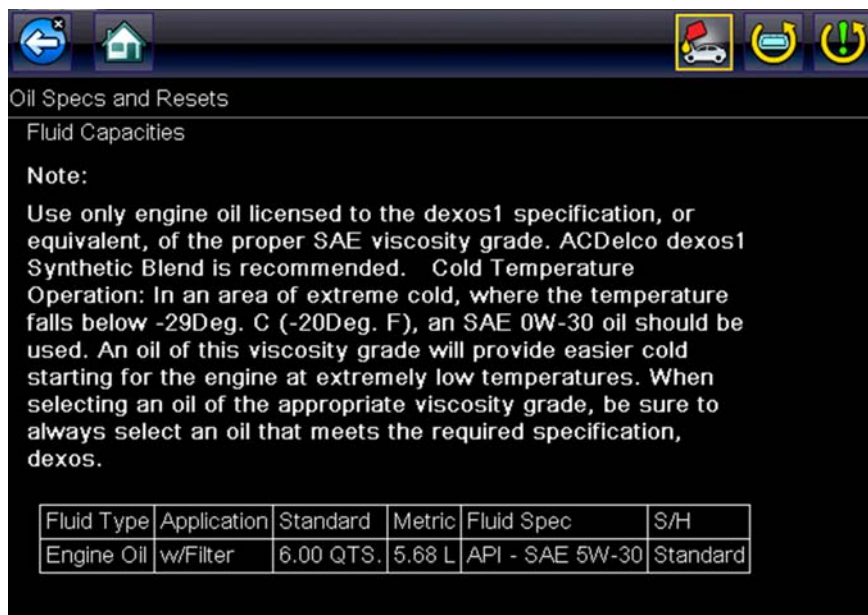

Figure 9-3 Typical Oil Specification Result

Functional Reset

Selecting **Functional Reset** opens the service interval reset menu (within the Scanner function) for the selected vehicle, and includes functional resets for the oil service indicator and other supported resets.

IMPORTANT:

Instructions may be provided, that are required to be performed before selecting or completing the reset function itself. Follow all instructions as written.

NOTES:



Functional resets are not available for all vehicles, and will vary depending on vehicle support.

A "grayed out" or non-selectable icon indicates that functional resets are not available for the selected vehicle.

Service interval reset menu titles will vary by manufacturer.

1. Select the **Functional Reset** icon.

The Scanner function opens to the service interval reset menu for the selected vehicle.

2. Select the applicable menu option(s) to perform the functional reset.
3. Read and perform any instructions that are provided.
4. If applicable, once the reset has completed select **OK** or **Continue**.

The following screen examples (Figure 9-4) illustrate the typical engine oil life indicator reset menu navigation for a 2011 Honda Accord. Other vehicle manufacturer menu navigation will vary.

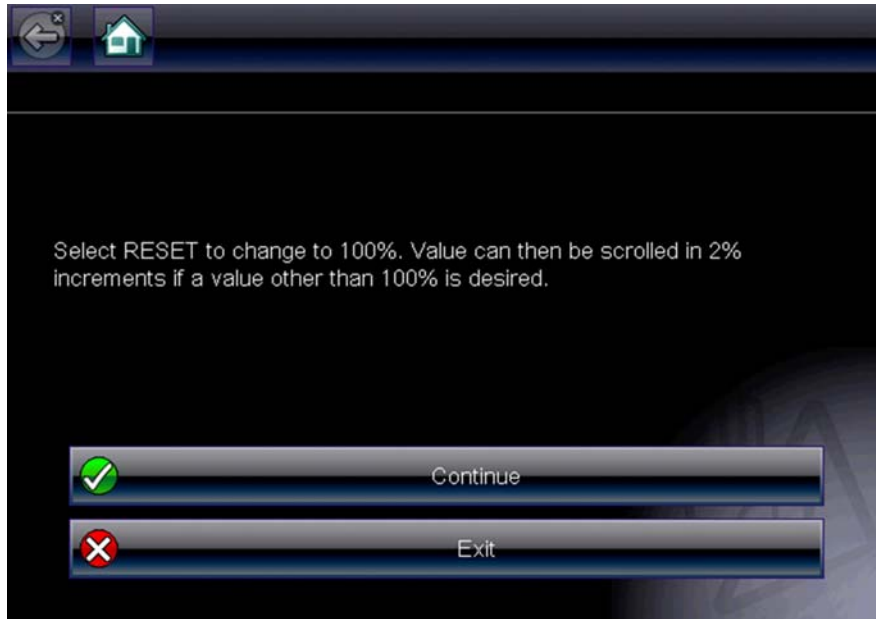

Figure 9-4

9.1.2 Reset Procedure

Selecting **Reset Procedure** displays OEM oil service reset instructions. Typical information may include:

- Step-by-step instructions for manually resetting the oil service reset indicator using on-board vehicle functionality (e.g. instrument cluster controls, accelerator pedal, information or media center controls, multi-function switch, etc.)
- Special notes, and/or instructions
- Theory of operation



NOTE:

During content download, icons may be used as image place holders until the image is fully downloaded, and can be displayed.

Use the scroll bar or directional buttons (▲, ▼) to scroll up/down to view all of the information.

The following are examples (Figure 9-5) of typical oil service reset instructions. Instructions and screens will vary by vehicle.

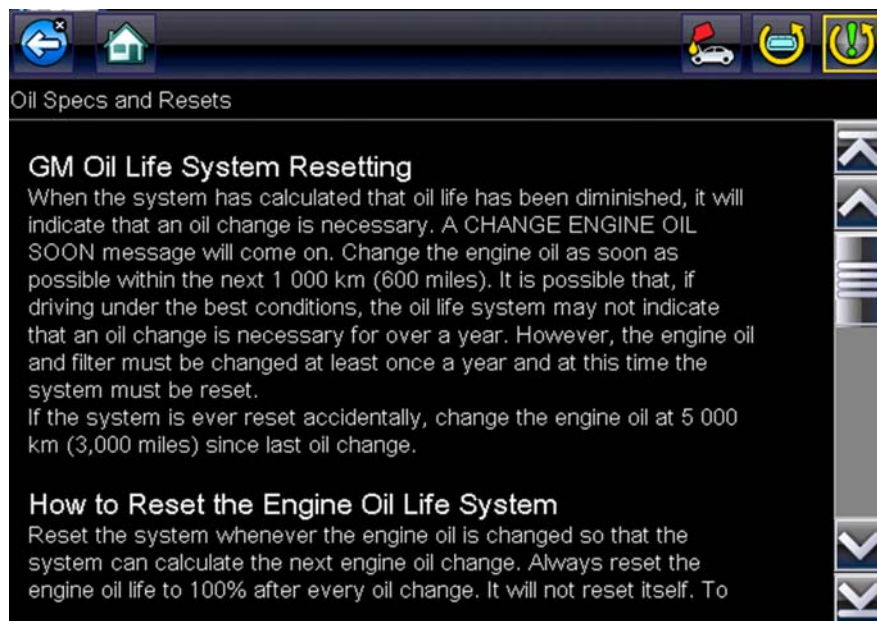

Figure 9-5

Viewing Images

Images may be provided within the reset instructions. Depending on the image, it may require enlargement to see details within the image.

1. If you need to see an image in greater detail, tap the image to select it (Figure 9-6).



Figure 9-6

Selecting an image, opens it in a viewer window (Figure 9-7).

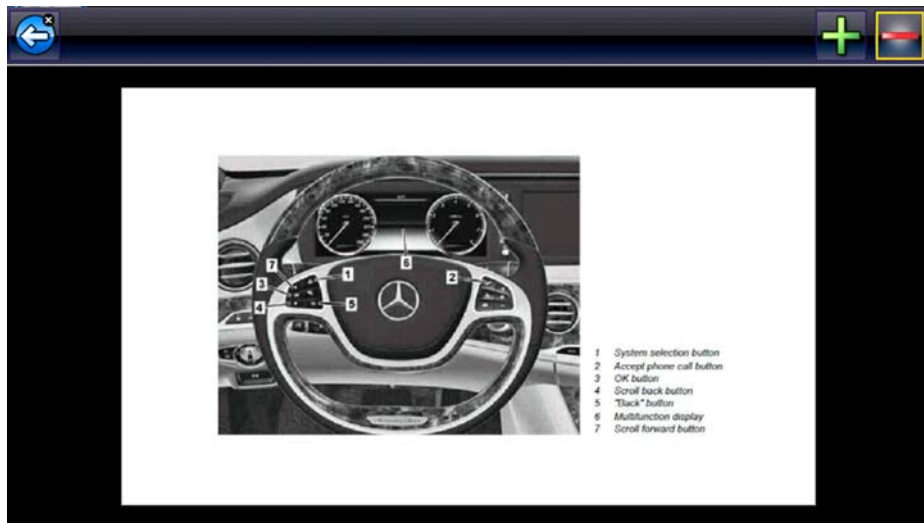

Figure 9-7

Use the zoom and pan features described in this section to adjust the image as needed.

Zoom

From the image viewer window, select the + and - icons from the toolbar to incrementally increase or decrease the image displayed (Figure 9-8).



Figure 9-8

Pan

To move the image, touch, hold and drag the image on the screen to reposition it (Figure 9-9).



Figure 9-9

9.2 Tire and Wheel Service

Tire and Wheel Service is located in the Quick Lookups main menu (**Quick Lookups > Tire and Wheel Service**).

Tire and Wheel Service provides OEM information on your diagnostic tool, via wireless network connection with our Snap-on Information Service. This feature allows you quick access to the following information:

- **Tire Pressure Monitoring System (TPMS) Indicator Reset Procedures**
- **TPMS Relearn Procedures**
- **Tire Pressure Sensor Removal/Installation Procedures**
- **Tire Fitment Specifications**

Tire and Wheel Service can also provide (when available) quick access to the following diagnostic functions when connected to a vehicle:

- **View and Clear TPMS Related Codes**
- **View TPMS Related Data**
- **Perform TPMS Related Functional Tests**
- **View TPMS Troubleshooter Information**



NOTE:

- Tire and Wheel Service vehicle coverage is the same as the Scanner vehicle coverage.
 - Not all vehicles may have on-board diagnostic tool reset capabilities, or have information available.
 - The diagnostic tool is equipped with the ability to connect to a Wi-Fi network, however the connection is solely dedicated to our Snap-on Information Service. Before you begin using this function you must connect to a wireless network and turn the Wi-Fi radio on. See [Wi-Fi Connection / Troubleshooting](#), on page 98 for instructions.
 - If you experience a wireless network connection loss, Tire Service information will not refresh and/or may cause the function to stop. To continue use, you must re-establish your Internet connection.
 - Performance may vary depending on your wireless network equipment and ISP.
-

9.2.1 Operation



NOTE:

The information and procedures provided by the Tire and Wheel Service function is vehicle specific, therefore a vehicle must be identified before information can be displayed.

▶ Using the Tire and Wheel Service function

There are two methods to access this function:

- **From the Home screen** - select the **Quick Lookups** icon, then select **Tire and Wheel Service** (Figure 9-10), and then proceed to Step 1 below.

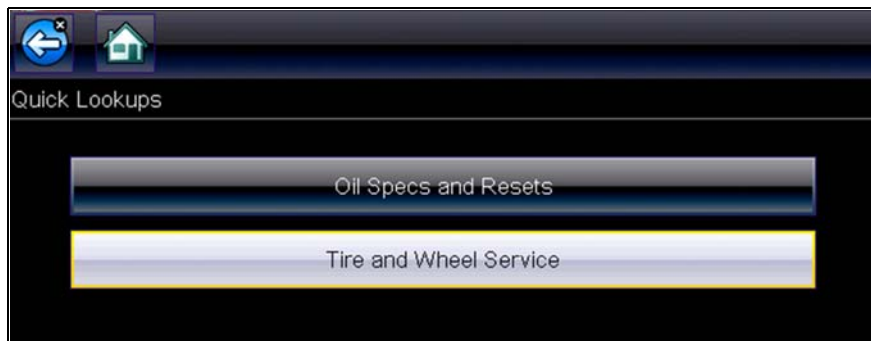

Figure 9-10

- **From within a current Scanner session** - select **Tire and Wheel Service** (or applicable choice) from the System menu (Figure 9-11), then proceed to Step 3 below.

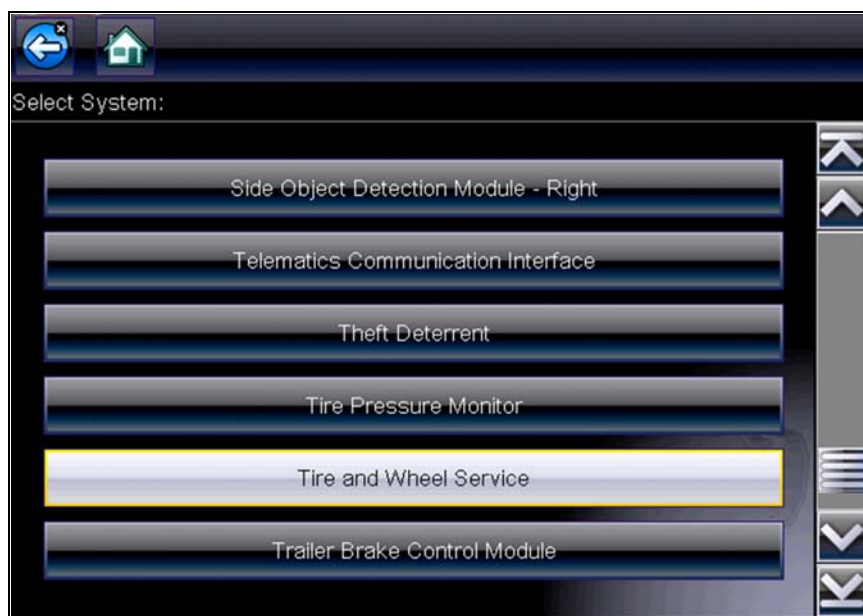

Figure 9-11 Scanner System Menu

1. Follow the screen prompts to select the vehicle, **Manufacturer**, **Year** and **Model**.
2. Select **OK** to confirm the vehicle.
3. After the TPMS Reset instruction screen displays, you can navigate to other options as needed, see [Tire and Wheel Service Toolbar Icons](#).







NOTE:

Depending on the active function, descriptive information is displayed in the main body of the screen. If applicable, use the scroll bar to scroll up/down to view all of the information.

Tire and Wheel Service Toolbar Icons

The following provides a brief description of the related Tire and Wheel Service toolbar icon functions. Detailed descriptions are provided in the following sections.

Icon	Icon Name	Description
	TPMS Indicator Reset	Displays TPMS indicator reset instructions, to perform a manual reset of the TPMS indicator. See TPMS Indicator Reset .
	Remove and Repair (TPMS Service)	Displays TPMS service information. See TPMS Indicator Reset .
	Scanner Functions	Opens the TPMS test related Scanner menu. Options may include, view and clear codes, display data, and access functional tests using the diagnostic tool.
	Tire/Wheel Specifications (Fitment)	Displays OEM tire and wheel specifications.

TPMS Indicator Reset



Selecting the **TPMS Indicator Reset** icon displays TPMS indicator reset instructions. Typical information may include:

- Instructions for manually resetting the TPMS indicator using on-board vehicle functionality.
- Special notes, and/or instructions
- Theory of operation

During content download, progress messages may display until the image is fully downloaded, and can be displayed.

Use the scroll bar to scroll up/down to view all of the information.

The following example (Figure 9-12) shows a typical TPMS indicator reset instructions. Instructions and screens will vary by vehicle.

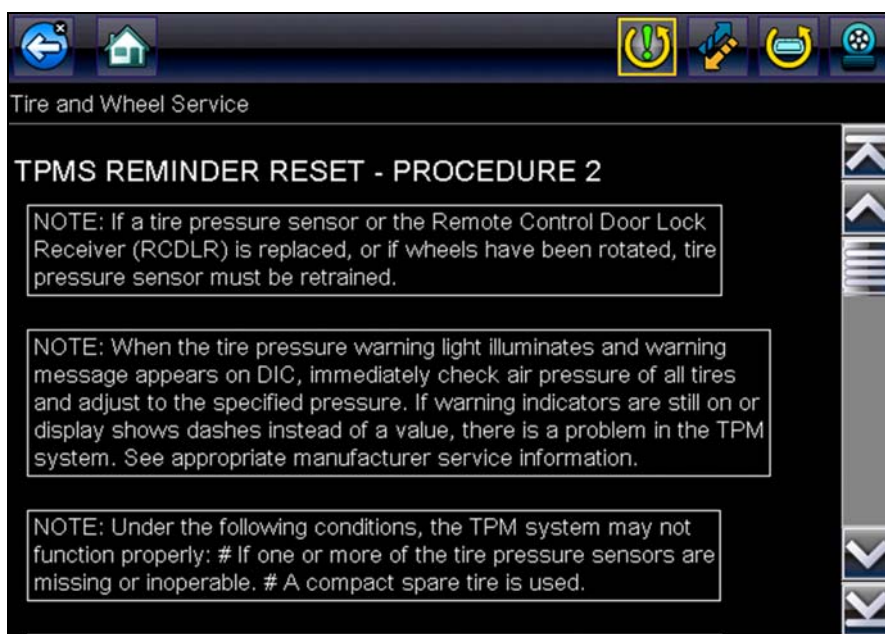

Figure 9-12

TPMS Remove & Repair (TPMS Service)



Selecting the **Remove & Repair (TPMS Service)** icon displays TPMS service information. Typical information may include:

- Removal and installation instructions.
- Relearn/enable procedures
- Diagnostic testing procedures
- Theory of operation

During content download, progress messages may display until the image is fully downloaded, and can be displayed.

Use the scroll bar to scroll up/down to view all of the information.

The following are examples (Figure 9-13) of typical TPMS service procedures. screens, results will vary by vehicle.



Figure 9-13

Scanner Functions



Selecting the **Scanner Function** icon opens the TPMS Scanner test menu for the selected vehicle. Options may include:

- View and Clear Codes
- View Data
- Perform TPMS Related Functional Tests/Resets
- View TPMS Troubleshooter Information

IMPORTANT:

Functional test instructions may be provided, that are required to be performed before selecting or completing the function itself. Follow all instructions as written.



NOTE:

Scanner functions require connection and communication with the vehicle.

Functional tests/resets are not available for all vehicles, and will vary depending on vehicle support.

A “grayed out” or non-selectable icon indicates that functional resets/rests are not available for the selected vehicle.

Service test/reset menu titles will vary by manufacturer.

The following screen examples (Figure 9-14) illustrate some typical TPMS functional test screens.

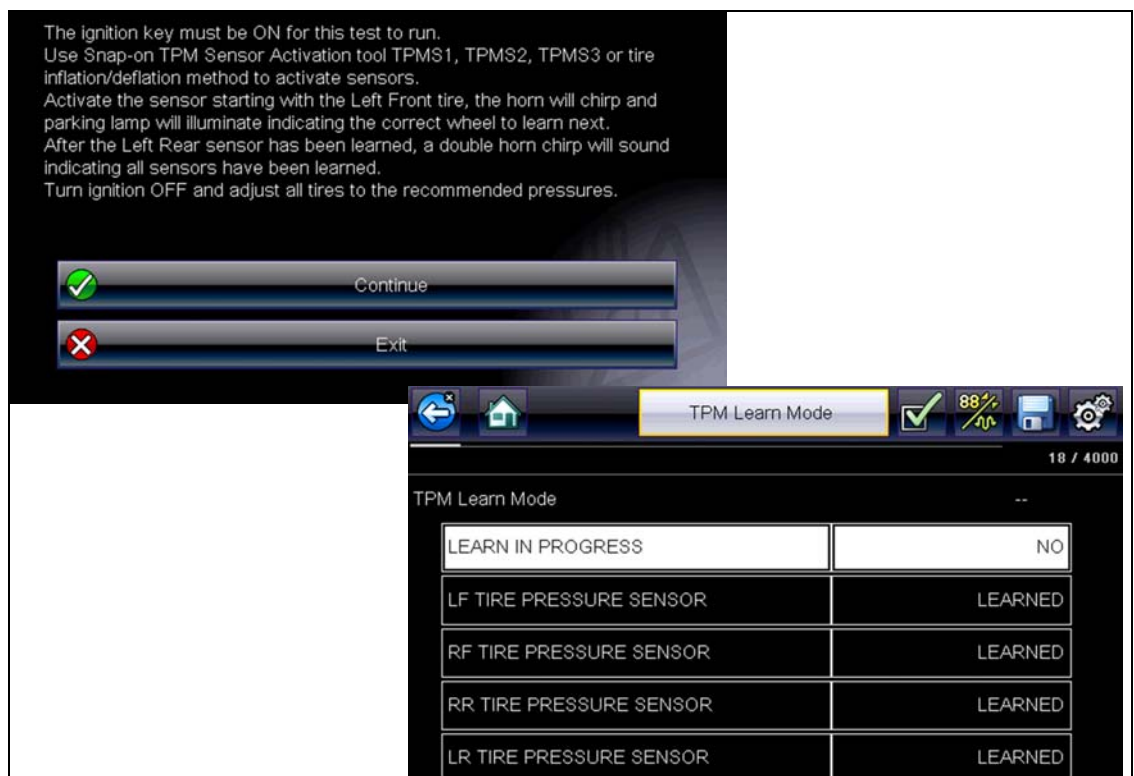

Figure 9-14

Tire/Wheel Specifications (Fitment)



Selecting **Tire/Wheel Specifications** displays OEM tire and wheel specifications (Figure 9-15).

Typical information may include:

- Tire size and pressure
- Wheel hub stud size and lug torque
- Wheel size

The screenshot shows a software interface for 'Tire and Wheel Service'. At the top, there is a navigation bar with icons for back, home, refresh, and other functions. Below the navigation bar, the title 'Tire and Wheel Service' is displayed. The main content area is titled 'Tire Fitment' and contains a table with the following data:

Drive Type	Body Style	Vehicle Option	GVWR (lbs)	Front Rear Both	Size Description	Standard Optional	Inflation (psi) Front-Rear	Torque (ft-lbs)	Wheel Base (in) Min-Max
FWD	4D Sedan		Not Applicable	B	P225/55R17 95T	S	30 - 30	100	

Below the table, a note reads: **Note: Always refer to the vehicle placard and/or owner's manual**

Figure 9-15 Typical Tire and Wheel Specification Result

This chapter describes the basic operation of the Previous Vehicles and Data function.



The **Previous Vehicles and Data** icon is located on the Home screen. This function allows you to select recently tested vehicles and access saved data files.

10.1 Previous Vehicles and Data Menu

The following options are available from the Previous Vehicles and Data menu:

- [Vehicle History](#)
- [View Saved Data](#), on page 80,
- [Delete Saved Data](#), on page 82,

10.1.1 Vehicle History

The diagnostic tool stores the identification of the last twenty-five (25) vehicles tested, so there is no need to go through the complete vehicle identification sequence when performing a retest after repairs have been made. The oldest vehicle record is deleted when a new vehicle is identified once there are twenty-five vehicles on file.



Figure 10-1 Vehicle history list



To select from the vehicle History:

1. Select **Previous Vehicles and Data** from the Home screen.
2. Select **Vehicle History**.
A list of up to 25 previously tested vehicles displays. Each vehicle is given a unique file name. Scroll to view the entire list.
3. Select a vehicle from the list.
A vehicle ID confirmation screen displays.
4. Select **OK** or press the **Y/✓** button to continue.

10.1.2 View Saved Data

Selecting the **View Saved Data** menu option opens a list of all the saved data (movie) files and screen images that are stored in memory. Saved files are listed in chronological order by the date and time that they were created with the most recent files are at the top of the list.



Figure 10-2 Saved data list

Saved files can either be opened directly on the diagnostic tool, or downloaded to a personal computer and opened using [ShopStream Connect](#), on page 106,. See [View Saved Data](#), on page 80, and [Connect-to-PC](#), on page 84, for additional information.



NOTE:

A maximum of fifty (50) files can be displayed on the diagnostic tool. If more than 50 files have been saved, use ShopStream Connect (SSC) to view them all, see [Connect-to-PC](#), on page 84, for additional information.

**To review a saved data file or image:**

1. Select **Previous Vehicles and Data** from the Home screen.
2. Select **View Saved Data**.
3. Select a file to review from the list.

10.1.3 Viewing Codes and Code Scan Results

When code scan or single system code results are saved, they are saved in (.XML) file format (Figure 10-3).



Figure 10-3 Typical - Code Results (.XML) file

The saved (.XML) file(s) can be viewed using these methods:

- On the diagnostic tool - See [Viewing Code Results on the Diagnostic Tool](#), on page 81,.
- In report format using:
- ShopStream Connect - see [Printing the Code Scan Report](#), on page 110,.



Viewing Code Results on the Diagnostic Tool

Selecting a system code or a code scan results file from your saved file list (Figure 10-4), opens the file onscreen. When opened, the (.XML) file displays basic vehicle information and a list of DTCs with a brief description of each.

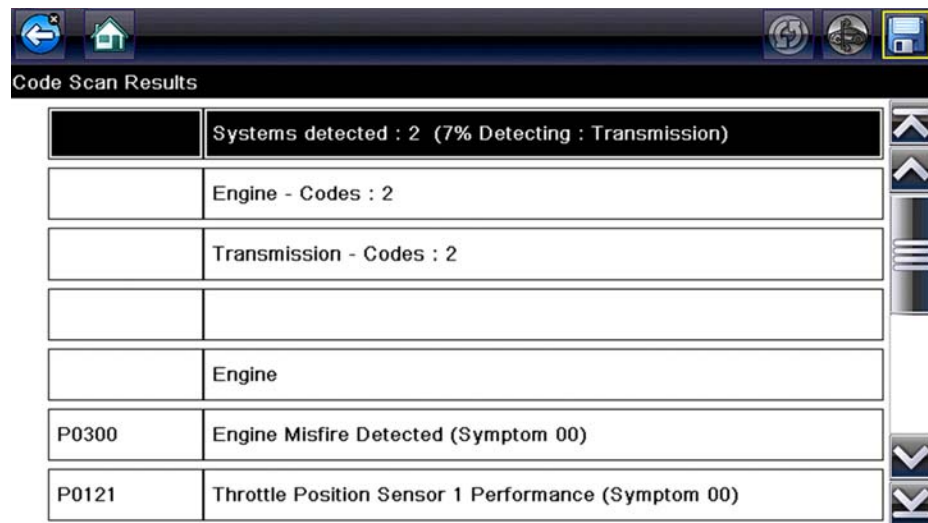

Figure 10-4 Typical - Code Scan Results (.XML file) viewed onscreen

10.1.4 Delete Saved Data

This menu option is used to permanently delete saved files from memory.



To delete a saved file:

1. Select **Previous Vehicles and Data** from the Home screen.
2. Select **Delete Saved Data**.
A list of saved files displays.
3. To delete an individual file, select a file from the list (a check mark displays in the checkbox).
4. Select the **Delete** icon (shown left) from the toolbar



A confirmation message displays.

5. Select an option from the confirmation message:
 - **OK**—deletes the selected file and returns to the saved files list, which no longer includes the deleted file.
 - **Cancel**—returns to the saved files list without deleting the selected file.



NOTE:

Use the **Select All/Deselect All** icon (shown left) from the toolbar to quickly delete files.



This chapter describes the basic operation of the Tools function.



The **Tools** icon is located on the Home screen. This function allows you to configure diagnostic tool settings to your preferences.

11.1 Tools Menu

The following options are available from the Tools menu:

- **Connect-to-PC**—use to transfer and share files with a personal computer (PC).
- **Get Connected**—displays the Snap-on profile authorization codes to use when registering for secured gateway access. For instructions on connecting to Fiat® Chrysler® Automobiles (FCA) with a Secure Gateway Module, visit: snapon.com/gateway
- **Configure Shortcut Button**, on page 85—use to change the function of the shortcut button.
- **System Information**, on page 85—use to view configuration information for the diagnostic tool.
- **Settings**, on page 86—use to configure certain characteristics of the diagnostic tool.

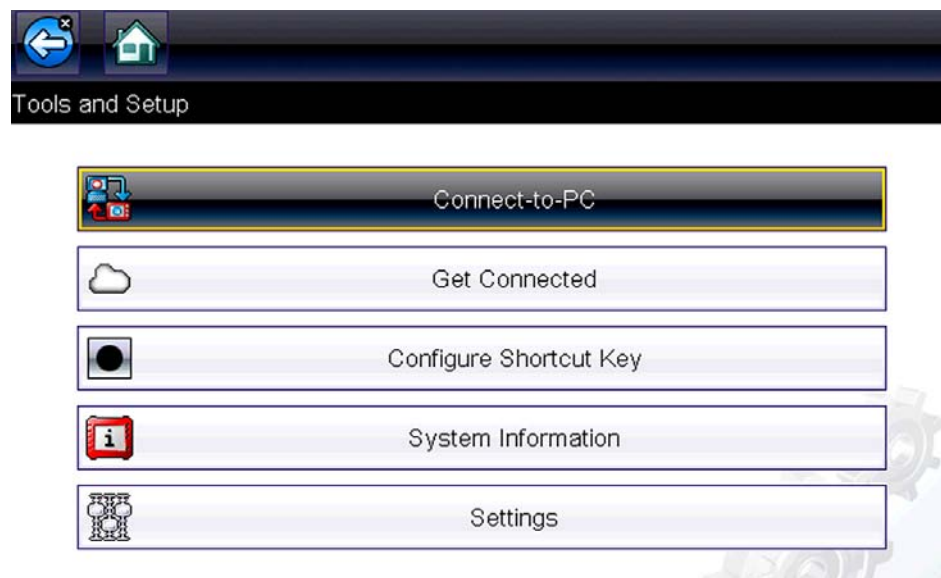

Figure 11-1 Tools menu

11.1.1 Connect-to-PC

Connect-to-PC allows you to transfer saved data files on your diagnostic tool to your personal computer using a USB cable.

The optional ShopStream Connect™ PC software allows you to view, print and save data files on your PC. In addition, you can download software updates from the PC to the diagnostic tool. These features provide an ideal way to manage saved data files. The ShopStream Connect application is available free online, see [ShopStream Connect](#), on page 108 for additional information.



To connect the diagnostic tool to a PC:

1. Connect the supplied USB cable to the diagnostic tool and then to the PC.
A USB cable, supplied with your diagnostic tool, is used to connect the diagnostic tool to the PC. When the diagnostic tool is connected to the PC a communications icon appears on the right edge of the title bar.
2. Select **Tools** from the Home screen.
3. Select **Connect-to-PC** from the Tools and Setup menu.
A screen message will display to confirm the tool is in Connect-to-PC-mode.



This device is now in Connect-to-PC mode.

Press  to exit.



Figure 11-2

11.1.2 Configure Shortcut Button

This feature allows you to change the function of the **Shortcut** button. Options are:

- **Brightness**—opens the brightness setting screen.
- **Save Screen**—saves a bitmap image of the visible screen.
- **Save Movie**—writes PID data from buffer memory to a file for future playback.
- **Show Shortcut Menu**—opens the menu so you can quickly select from any of the functions.
- **Toggle Record/Pause**—programs the Shortcut button to work as the Pause and Play icons.



To assign a function to the Shortcut button:

1. Select **Tools** from the Home screen.
The Tools menu opens.
2. Select **Configure Shortcut button** from the menu.
3. Select a function from the menu.
4. Select the **Back** on the toolbar or press the **N/X** button to return to the options menu.

11.1.3 System Information

System Information displays important information such as:

- Patent information
- Software version numbers
- Diagnostic Tool serial number



Figure 11-3 System information



To display the System information screen:

1. Select **Tools** from the Home screen to open the menu.
2. Select **System Information** from the menu.
The System Information screen displays.

3. Scroll as needed to view all of the data.
4. Select **Back** on the toolbar or press the **N/X** button to return to the options menu.

11.1.4 Settings

This Tools selection allows you to adjust certain basic diagnostic tool functions to your personal preferences. Selecting opens an additional menu that offers the following:

- System Settings - see [System Settings](#), on page 86
- Configure Scanner - see [Configuring Scanner](#), on page 92
- Configure Units - see [Configure Units](#), on page 93

System Settings

Selecting System Settings opens a menu with two options; Display and Date & Time. Either selection opens an additional menu.

Display options include:

- [Brightness](#), on page 87—adjusts the intensity of the screen back lighting.
- [Color Theme](#), on page 87—changes the background color of the screen display.
- [High Contrast Toolbar](#), on page 88—enhances toolbar graphics for poor lighting conditions.
- [Font Type](#), on page 88—switches between standard and bold text for better visibility.
- [Backlight Time](#), on page 89—adjusts how long the screen stays on with an idle diagnostic tool.
- [Touch Screen Calibration](#), on page 89—calibrates the touch screen display.

Date & Time options include:

- [Time Zone](#), on page 90—sets the internal clock to the local time standard.
- [Clock Settings](#), on page 91—sets the time on the internal clock.
- [Daylight Savings Time](#), on page 91—configures the clock for Daylight Savings Time.
- [Time Format](#), on page 92—switches the time displays between a 12 or 24 hour clock.
- [Date Format](#), on page 92—configures how the month, date, and year displays.

Brightness

Selecting this option opens the brightness setting screen for adjusting the back lighting of the display (Figure 11-4).



Figure 11-4 Brightness setting

Each push of the **Plus** and **Minus** icons, or the up (▲) and down (▼) arrows, incrementally changes the back lighting up or down respectively.

Select **Back** from the toolbar or press the **N/X** button to exit.

Color Theme

This option allows you to select between a white and black background for the screen. The black background can be beneficial when working under poor lighting conditions.

Selecting opens a menu with two choices: **Day Theme** (white background) and **Night Theme** (black background). Make a selection and a "please wait" message momentarily displays followed by the Home screen. The new toolbar setting is now active.

High Contrast Toolbar

This option allows you to switch to a high contrast toolbar. This toolbar features black and white icons with crisp graphics that are easier to see in poor lighting conditions or bright sunlight.

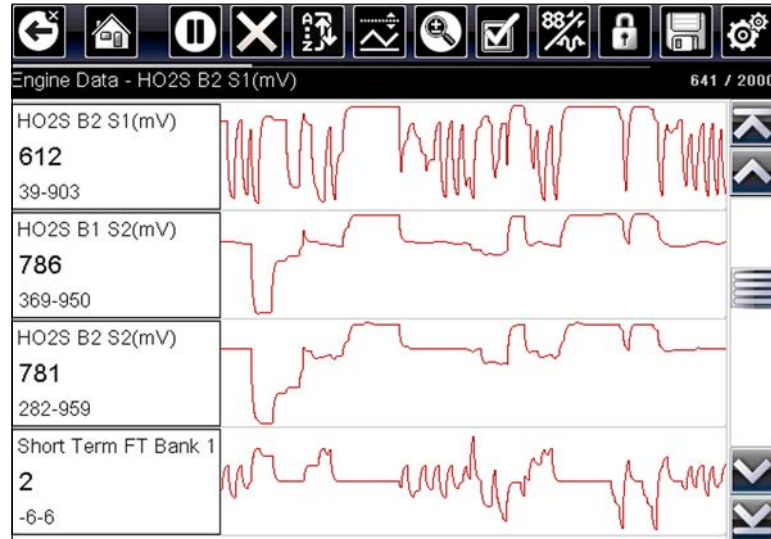

Figure 11-5 High-contrast toolbar

Selecting opens a menu with two choices; **Color Toolbar** and **High Contrast Toolbar**. Select and a "please wait" message displays followed by the Home screen. The new setting is now active.

Font Type

This option allows you to select between standard and bold faced type for the display screen. Bold type makes screen writing more legible under poor lighting or bright sunlight conditions.

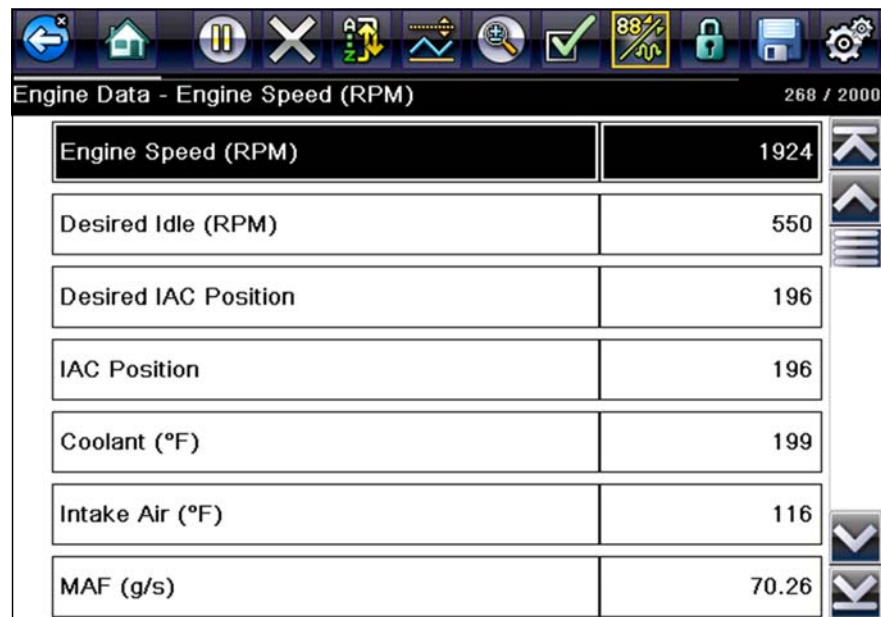

Figure 11-6 Bold type on a black background

Selecting opens a menu with two choices: Normal Font and Bold Font. Select a menu item or scroll and then press the **Y/✓** button to make a selection. The change is instantaneous. Select the Back or Home icon on the toolbar to return to either the Settings menu or the Home screen.

Backlight Time

This option allows you to configure how long the screen backlight remains on when the diagnostic tool is inactive. The following choices are available:

- Always On
- 15 Seconds
- 30 Seconds
- 45 Seconds
- 60 Seconds

Select the menu item desired, or scroll and then press the **Y/✓** button to make a selection. Select **Back** or **Home** on the toolbar to return to either the Settings menu or the Home screen.

Touch Screen Calibration

Calibrating the touch screen maintains the accuracy of the touch-sensitive display.

IMPORTANT:

To avoid serious damage to the diagnostic tool, always complete the touch screen calibration sequence once it has begun. **Never turn off the diagnostic tool while a screen calibration is in process.**



To calibrate the touch screen:

1. Select **Tools** from the Home screen to open the menu.
2. Select **Settings** from the menu.
3. Select **Touch Calibration** from the menu.
The calibration screen opens ([Figure 11-7](#)).

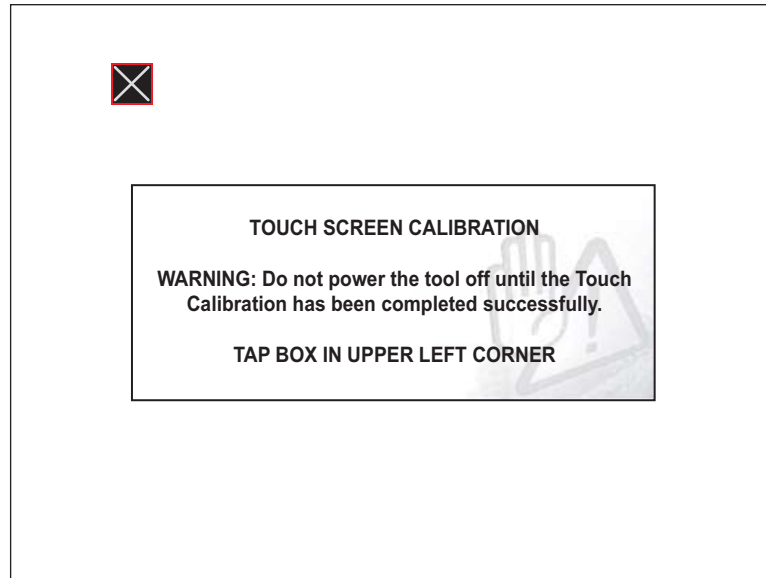

Figure 11-7 Touch screen calibration

4. Select each box on the screen as it displays.
The display returns to the Settings menu once the screen calibration procedure is complete.

Time Zone

This option opens a menu of time zone settings. Scroll to highlight, then select the local time zone. The display returns to the Settings menu once a time zone is selected.

IMPORTANT:

A notice that saved files may be overwritten momentarily displays whenever an option that alters the internal clock setting is selected (Figure 11-8). Be sure to transfer any critical files to a PC before continuing with the selected option.

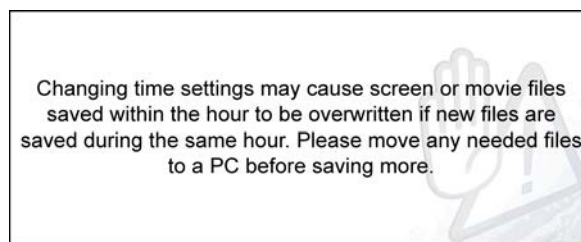

Figure 11-8 Sample possible data loss message

Clock Settings

This option opens a window for resetting the time on the real-time clock.



To set the clock:

1. Select **Tools** from the Home screen to open the menu.
2. Select **Settings** from the menu.
3. Select **Clock Settings** from the menu.

A warning message briefly displays followed by the Clock Settings screen ([Figure 11-9](#)).

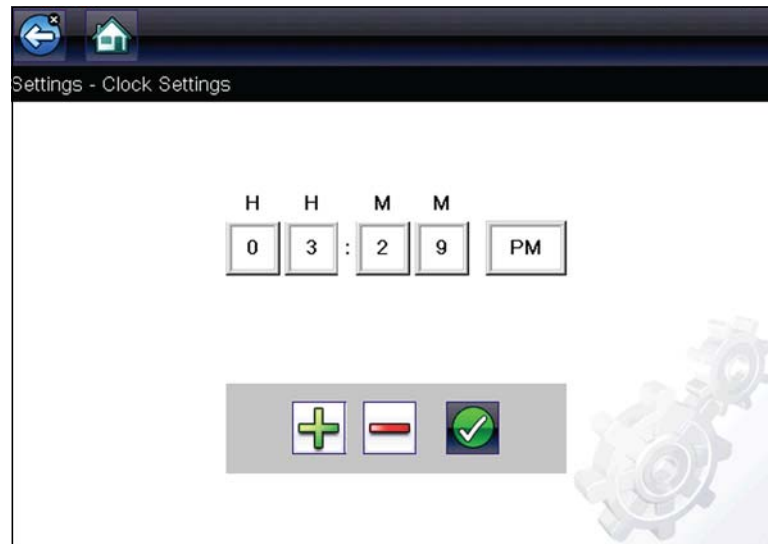

Figure 11-9 *Clock settings*

4. Select the **up (+)** icon on the screen or press the **up (▲)** button to incrementally increase the number in the highlighted field. Select the **down (-)** icon on the screen or press the **down (▼)** button to incrementally decrease the number.
5. Select the **check (✓)** icon on the screen or press the **Y/✓** button to move the highlight to the next field.
6. Repeat Step 4 and Step 5 until the correct time is displayed.
7. Select the **Back** icon on the toolbar or press the **N/X** button to close the Clock Settings window and return to the Settings menu.

Daylight Savings Time

This option opens a menu to configure the internal clock for Daylight Savings Time. Choose from:

- **ON**—sets the clock for Daylight Savings time.
- **OFF**—sets the clock for standard time.

Make either selection, then select the **Back** icon or press the **N/X** button to return to the menu.

Time Format

This option determines whether time is displayed on a 12 or 24 hour clock. Selecting opens a menu with two choices:

- **24 Hour Format**
- **12 Hour Format**

Make either selection, then select the **Back** icon or press the **N/X** button to return to the menu.

Date Format

This option allows you to select how date information is displayed. Select from:

- **(MM_DD_YYYY)**—Month, Day, Year
- **(DD_MM_YYYY)**—Day, Month, Year
- **(YYYY_MM_DD)**—Year, Month, Day

Make a selection, then select the **Back** icon or press the **N/X** button to return to the menu.

Configure Wi-Fi - Setup, Testing and Troubleshooting

See [Wi-Fi Connection / Troubleshooting](#), on page 98.

Configuring Scanner

This option allows you to change the scanner display to toggle scales on and off. Scales are the graduations and values that display on the horizontal axis at the base of the parameter graphs. The waveform fills the entire graph area with scales switched off.

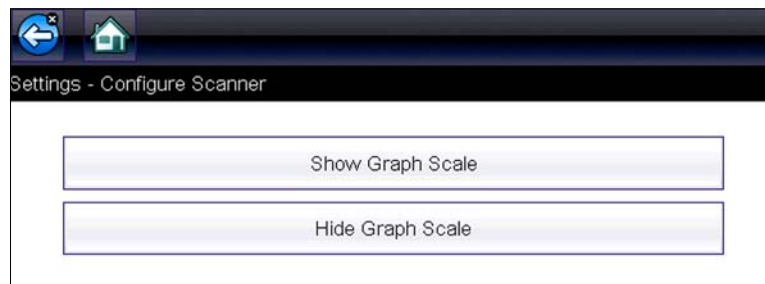

Figure 11-10 *Scales hidden*



To change hide/show scales:

1. Select **Tools** from the Home screen.
2. Select **Settings** from the Tools and Setup menu.
3. Select **Configure Scanner** from the Settings menu.
4. Highlight either menu entry to make a selection:
 - **Show Graph Scale**—to switch the scales on.
 - **Hide Graph Scale**—to switch the scales off.
5. Select the **Back** icon or press the **N/X** button to return to the Settings menu.

Configure Units

Selecting opens a dialog box that allows you to choose between US customary or metric units of measure for temperature, vehicle speed, air pressure, and other units.



Figure 11-11 Configure units menu



To change the units setup:

1. Select **Tools** from the Home screen to open the menu.
2. Select **Configure Units** to open the menu.
3. Select an item from the Configure Units menu.
4. Select a setting from the listed choices.
5. Select **Back** on the toolbar or press the **N/X** button to return to the options menu.

This chapter describes basic cleaning and battery replacement procedures for your Diagnostic Tool.

12.1 Cleaning and Inspecting the Diagnostic Tool

Periodically perform the following tasks to keep your Diagnostic Tool in proper working order:

- Check the housing, cables and connectors for dirt and damage before and after each use.
- At the end of each work day, wipe the Diagnostic Tool housing, cables and connectors clean with a damp cloth.

IMPORTANT:

Do not use any abrasive cleansers or automotive chemicals on the Diagnostic Tool.

12.1.1 Cleaning the Touch Screen

The touch screen can be cleaned with a soft cloth and a mild window cleaner.

IMPORTANT:

Do not use any abrasive cleansers or automotive chemicals on the touch screen.

12.2 Battery Pack Service

Follow all safety guidelines when handling the battery pack.

 WARNING

Risk of electric shock.

- **Prior to recycling the battery pack, protect exposed terminals with heavy insulating tape to prevent shorting.**
- **Disconnect all test leads and turn Diagnostic Tools off before removing the battery pack.**
- **Do not attempt to disassemble the battery pack or remove any component projecting from or protecting the battery terminals.**
- **Do not expose the Diagnostic Tool or battery pack to rain, snow, or wet conditions.**
- **Do not short circuit the battery terminals.**

Electric shock can cause injury.

 **WARNING**

Risk of explosion.

- **Use the proper factory battery pack only, incorrect replacement or tampering with the battery pack may cause an explosion.**

Explosion can cause death or serious injury.

12.2.1 Battery Pack Safety Guidelines

IMPORTANT:

The battery pack contains no user serviceable components. Tampering with the battery pack terminals or housing will void the product warranty.

Keep the following in mind when using and handling the battery pack:

- Do not short circuit battery terminals.
- Do not immerse the Diagnostic Tool or battery pack in water, or allow water to enter the Diagnostic Tool or battery compartment.
- Do not crush, disassemble, or tamper with the battery pack.
- Do not heat the battery pack to over 100°C (212°F), or dispose of it in a fire.
- Do not expose the battery pack to excessive physical shock or vibration.
- Keep the battery pack out of reach of children.
- Do not use a battery pack that appears to have suffered abuse or damage.
- Store the battery pack in a cool, dry, well ventilated area.



NOTE:

The battery pack should be used within a short period of time (about 30 days) after charging to prevent loss of capacity due to self-discharging.

If long-term storage of the battery pack is necessary, it should be stored in a cool, dry, well ventilated place with a 30 to 75 percent state of charge to prevent loss of characteristics.

To prolong the life of your battery, power off the Diagnostic Tool when not in use. The Diagnostic Tool has a built in charger that recharges the battery on demand whenever it is connected to a power source.

12.2.2 Replacing the Battery Pack

If the battery pack no longer holds a charge, contact your sales representative to order a new battery.

IMPORTANT:

Replace the battery pack with original Snap-on replacement parts only.

**To remove the battery pack:**

1. Loosen the battery cover screw, until the battery cover is loose from the housing.
2. Remove the battery pack cover.
3. Pull the bottom edge of the battery pack up then tilt it out to remove.

**To install the battery pack:**

1. Position the battery pack with the arrows (on the battery pack) facing up.
2. Tilt the top of the battery pack in to align the tabs, then down to install into place.
3. Install the battery pack cover, in the opposite manner as removal, aligning the tabs and tilting down and in into place.
4. Tighten the battery pack cover screw.

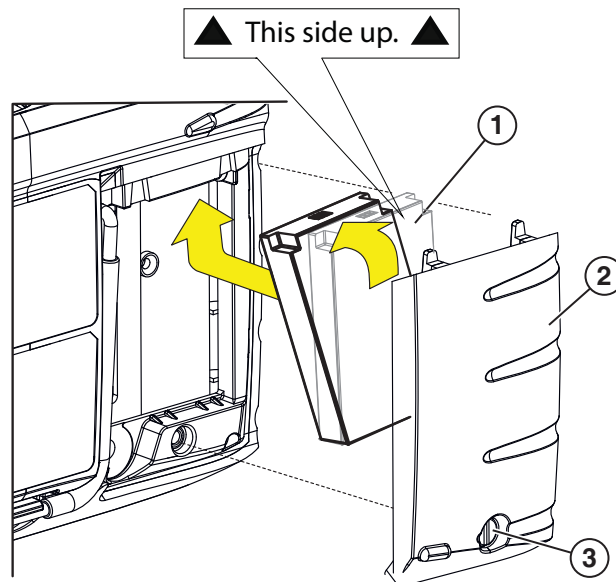

- 1— Battery Pack
2— Battery Pack Cover
3— Battery Pack Cover Screw

Figure 12-1

12.2.3 Disposing of the Battery Pack

Always dispose of a lithium-ion battery pack according to local regulations, which vary for different countries and regions. The battery pack, while non-hazardous waste, does contain recyclable materials. If shipping is required, ship the battery pack to a recycling facility in accordance with local, national, and international regulations.

- For additional information within the United States of America contact: Rechargeable Battery Recycling Corporation (RBRC) at www.call2recycle.org Phone - 800 822-8837
- For additional information within Canada contact: Rechargeable Battery Recycling Corporation (RBRC) at www.call2recycle.ca Phone - 888 224 9764

Products bearing the WEEE logo ([Figure 12-2](#)) are subject to European Union regulations.



Figure 12-2 WEEE logo



NOTE:

Always dispose of materials according to local regulations.

Contact your sales representative for details.

Wi-Fi Connection / Troubleshooting

The diagnostic tool is equipped with many features that require Wi-Fi connection. The Wi-Fi connection is solely dedicated to our Snap-on Web Services Network. To use features like Oil Specs and Resets, a Wi-Fi connection is required. This section includes information on Wi-Fi connection and troubleshooting.

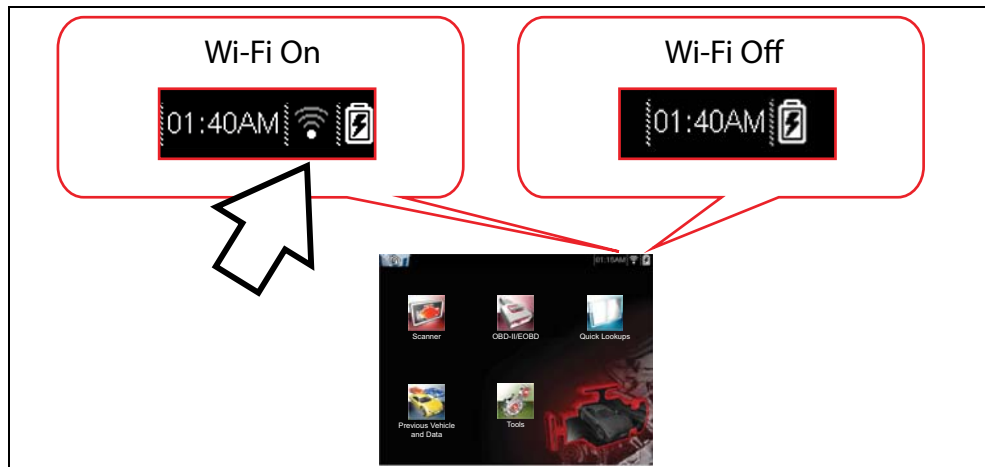

13.1 Checking if Wi-Fi is On/Off

If the Wi-Fi indicator is displayed in the title bar, Wi-Fi is on. If Wi-Fi is off, see *Turning On Wi-Fi and Connecting to a Network* to turn it on and connect.







13.2 Checking if Wi-Fi is Connected

Check the Wi-Fi indicator in the title bar:

	Wi-Fi is on and connected to a network (1 to 3 bars).
	Wi-Fi is on, but not connected (zero bars). See Wi-Fi Troubleshooting and Status Messages , on page 103.

13.3 Wi-Fi Icons (Setup)

Familiarize yourself with the following Wi-Fi icons and indicators from the Wi-Fi configuration screen.

Wi-Fi Icon (toggle type)		Wi-Fi Test Icon	Wi-Fi Signal Strength Indicator	
				
Indicates Wi-Fi is OFF	Indicates Wi-Fi is ON	Select to open the Wi-Fi Test screen	Zero bars indicates no signal	Three bars indicate full strength signal
Displayed on Wi-Fi configuration screen only			Displayed on the title bar next to the battery level indicator	

13.4 Turning Wi-Fi On and Connecting to a Network

1. From the Home screen, select **Tools > Settings > Configure Wi-Fi**.
2. Select the **Wi-Fi off** icon (Figure 13-1) to turn Wi-Fi on.



Figure 13-1 Wi-Fi Icon (shown off)

3. The Wi-Fi icon will change to indicate Wi-Fi is on (Figure 13-2). The screen will change to display available supported network connections.

4. Select your network. Use the scroll feature to show all active connections (Figure 13-2).

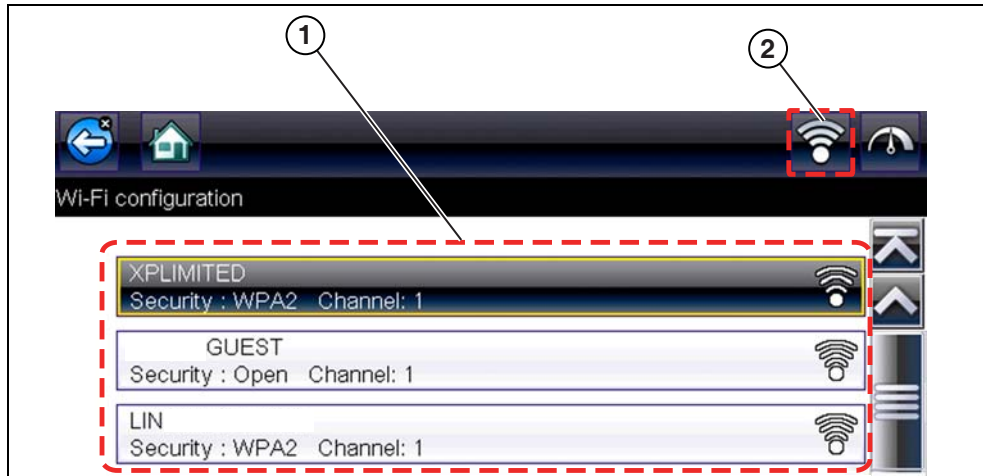

Figure 13-2 Wi-Fi Configuration Screen

- 1— Available Network Connections
 2— Wi-Fi Icon (Wi-Fi shown on)



NOTE:

A password is required when choosing a secured (protected) network. Enter the password using the on-screen keyboard and then select the check mark on the keyboard to continue.

Networks with a proxy, challenge page, or that require the user to accept terms of usage are not supported.

Wi-Fi performance varies depending on your wireless network equipment and ISP.

5. Select **Connect** to connect to your desired network or **Cancel** to cancel the request.
6. From the Connect confirmation screen select **OK** to continue using this connection or **Forget** to disconnect this connection.
 - If the status message “Not Connected” is displayed, retry the configuration process or see [Wi-Fi Testing](#), on page 101 for additional information.

13.5 Add Network Advanced (Connecting to a hidden network)

The Add Network selection allows you to connect to a network that is not broadcasting its name (not visible in the displayed network list). These networks are also known as "hidden" networks.

To connect to a hidden network you will first need to know the following:

- Network Security Type
 - Open (only need SSID)
 - WPA or WPA2 (Pre-shared key)
 - WEP (WEP key)
- Network name or SSID (Service Set Identifier)
- Network Password



Connecting to a Hidden Wi-Fi Network

1. From the Home screen, navigate to **Tools > Settings > Configure Wi-Fi**.
2. Select **Add Network Advanced** from the network list (scroll to end of list).
3. Select security type Open, WPA, WPA2, or WEP. Refer to the router user manual or your IT administrator to determine the type.
4. Enter the network name or SSID
5. Enter the network password.
6. Select **Connect** at the prompt to connect to the network.
7. Select **OK** at the confirmation screen to continue using this connection, or Forget to disconnect this connection.

13.6 Wi-Fi Testing

If you are experiencing network connection issues, an automated testing feature is available to quickly test your network connection.



Testing Connections

1. Before you start the automated testing procedure, turn off the diagnostic tool and then turn it on. This clears previous testing messages from memory.
2. Connect to your desired network, see [Turning Wi-Fi On and Connecting to a Network](#), on page 99.
3. From the Wi-Fi configuration screen, select the **Wi-Fi Test** icon to open the network connection test screen ([Figure 13-3](#)).



Figure 13-3 Wi-Fi Test Icon

The network connection test is an automated test that begins when the screen is displayed. Network connection systems are tested in sequence and display a status indicator (Red = test failed, Yellow = test is process, or Green = test completed satisfactorily) when finished (Figure 13-4).

Connectivity of the following systems are checked:

- **Hardware**
- **Router**
- **Internet**
- **HTTP**
- **Web Services Network**

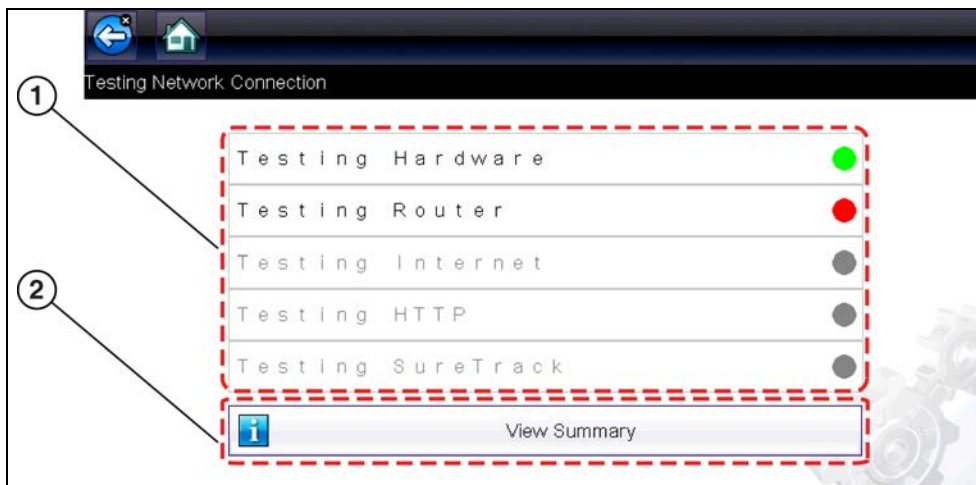

Figure 13-4 Connection Tests

1— Connection Tests

2— View Summary

4. If a connection issue(s) is present, select **View Summary** to review the results. The summary information is helpful if you are experiencing difficulties with your connection (Figure 13-5). Scroll through the summary information to review the test results for each system and Tip messages for the current connection issue. See *Connection Tests - Troubleshooting* chart in [Wi-Fi Troubleshooting and Status Messages](#), on page 103 for additional information.

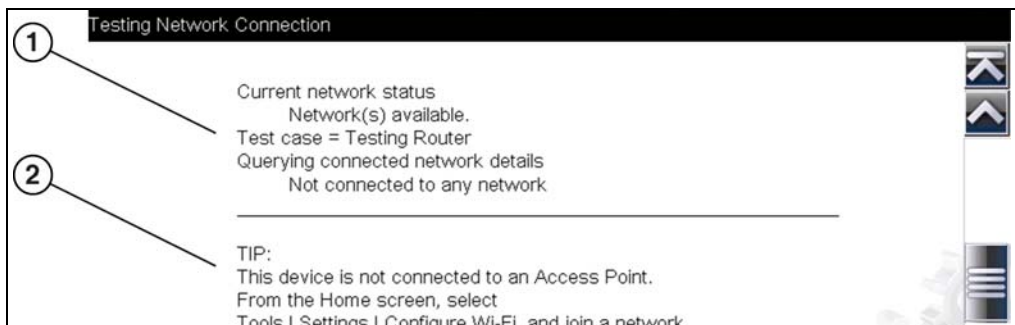

Figure 13-5 View Summary

1— Connection Test Results

2— Connection Issue Tip Message

13.7 Wi-Fi Troubleshooting and Status Messages

The following troubleshooting information is not inclusive and is meant as a guide only. Other issues and solutions may arise that are not stated here. The following description of terms are provided for reference as used in the following troubleshooting chart:

- **Router** - The data transmission device directly connected to your ISP.
- **Remote Wireless Access Point** - A wireless connection device between the router and your diagnostic tool.
- **Wi-Fi Radio** - The internal diagnostic tool radio transmitting and receiving Wi-Fi signals.
- **Network Connection** - Also called Wi-Fi connection. The configured Wi-Fi router connection the diagnostic tool connects to. This connection can be secured (password protected) or unsecured (open).

Router Information

Router compatibility and setup are important factors to check when trying to determine connectivity problems. Although we have tested this device at the factory to verify connectivity, we cannot guaranty its connectivity with your specific equipment. There may be some situations that require your time for router connection troubleshooting and/or additional consultation and equipment. Snap-on Incorporated is not responsible for any costs incurred for any additional equipment, labor or consultation charges or any other costs that may result from correcting non-connectivity issues with this device.

Check Router Settings

Verify the following router settings **BEFORE** you begin troubleshooting a non-connectivity or "No Connection" problem. After each check, make any corrections as necessary then retest for connectivity. **Contact your IT administrator or ISP for assistance.**

1. Check your router connection and if applicable, the remote wireless access point connection.
2. Clear saved Wi-Fi networks, see [Clearing Wi-Fi Networks](#), on page 103,.
3. Verify:
 - (a). Router is configured to use Dynamic Host Configuration Protocol (DHCP), not a static IP address.
 - (b). Router and/or settings for this device are configured to 2.4GHz. 5GHz is not supported.
 - (c). Router is configured to B/G and/or N standard wireless networks to 2.4GHz. 5GHz is not supported. See your router "User Guide" for setup, connection and troubleshooting procedures.
4. Check for router firmware and update to current version, if applicable.
5. Restart or reset the router. See your router "User Guide" for procedures.
6. Connect to a different router.

Clearing Wi-Fi Networks

1. Select the Wi-Fi network that you are trying to connect to from the list of saved networks on the Wi-Fi configuration menu.
The Wi-Fi Summary page displays.
2. Select **FORGET**
The Wi-Fi Configuration menu displays.

3. Repeat steps (1) and (2) for ALL saved Wi-Fi networks.
4. Once all saved Wi-Fi networks have been deleted (forgotten) turn off the diagnostic tool.
5. Turn on the diagnostic tool and connect to the desired Wi-Fi network, see [Turning Wi-Fi On and Connecting to a Network](#), on page 99,.

General -Troubleshooting		
Problem	Possible Cause	Corrective Action
Repair Information Applications (e.g. Intelligent Diagnostics, Oil Specs and Resets) are not available	Access has expired	Contact your sales representative.
	Access may be temporarily unavailable	Try to access the function at a later time as updates may be in process.
	Wi-Fi radio is turned Off	1. From the Home screen, navigate to Tools > Settings > Configure Wi-Fi . 2. Select the Wi-Fi icon and turn the Wi-Fi radio on. The Wi-Fi icon will change from a green check mark icon to red "X" mark icon indicating Wi-Fi radio is on. 3. Connect to a known good network.
	Not connecting to a network	1. Clear saved Wi-Fi networks, see Clearing Wi-Fi Networks , on page 103,. 2. Connect to a network. 3. From the Configure Wi-Fi screen select the Wi-Fi Test icon and review the results. See Connection Tests - Troubleshooting in the following table.
Wi-Fi connection drops off or disconnects intermittently	Wi-Fi Signal strength insufficient	Check Wi-Fi signal strength - out of range or interference. Move closer (within 50 Ft. (15 M) or into a direct open sight-line of the router or if applicable, remote wireless access point. Eliminate interference from overhead lights, windows, walls, other wireless devices, metal objects and devices that emit electrostatic discharge.
	Router overloaded	Disconnect/disable other Wi-Fi devices connected to the router.

Connection Tests - Troubleshooting		
Failed Test	Possible Cause (Displayed Tip Message*)	Corrective Action / Checks
Hardware	Wi-Fi radio not responding and/or will not turn off	Contact Customer Support for assistance.
	Wi-Fi radio not responding and/or will not initialize	
	Missing or corrupt firmware file(s)	

Router	This device is not connected to a router	Check Wi-Fi signal strength - out of range or interference. Move closer (within 50 Ft. (15 M) or into a direct open sight-line of the router or if applicable, remote wireless access point. Eliminate interference from overhead lights, windows, walls, other wireless devices, metal objects and devices that emit electrostatic discharge.
		Check router connection and setup. See Check Router Settings , on page 103, for procedure.
Internet	This device is not connected to the Internet or has no DNS	Check router connection and setup. See Check Router Settings , on page 103, for procedure.
		Domain Name System (DNS) server not connected. Contact your Internet service provider (ISP).
HTTP	This device cannot communicate using HTTP	Check if your Internet access uses a "Proxy" or "Accepting terms in a browser" protocol, or uses a challenge page. These protocols are not supported by this device. Contact your IT administrator or ISP for options.
Web Services Network (e.g.access to Intelligent Diagnostics, Oil Specs and Resets)	Your access has expired	Contact your sales representative.
	Repair Information Services may be temporarily unavailable or Not connecting to a network	Try to access at a later time as Repair Information Services may be performing updates to the service.
		Check router connection and setup. See Check Router Settings , on page 103, for procedure.
* See Wi-Fi Testing , on page 101, for additional information.		

13.7.1 Informative Messages

Messages may be displayed to inform you of pending issues or general status. Depending on your access and connection status, the following are typical messages that may be displayed:

- **Content May Be Available!** - indicates content may be available, however you are not currently connected to the Web Services Network. This message may be caused by a Wi-Fi connection issue, or you do not have access to the feature. See [Wi-Fi Troubleshooting and Status Messages](#), on page 103, for Troubleshooting information.
- **No connection. Please try again later.** - indicates you are not currently connected to the Web Services Network, except when displayed in the OBD/EOBD function as Repair Information Applications are not accessible in OBD/EOBD mode. If this message is displayed in the Scanner function, it may be caused by a Wi-Fi connection issue, or you do not have access to the feature. See [Wi-Fi Troubleshooting and Status Messages](#), on page 103, for Troubleshooting information.
- **Loading content** - indicates information is being accessed from the Web Services Network.
- **A new diagnostic software upgrade is available. Contact your sales representative for details.**
- **Your access has expired. See your Sales representative to renew.** - indicates your access to the Web Services Network has expired and you should contact your sales representative.

This chapter includes a brief introduction to some of the key features of the ShopStream Connect software. For detailed ShopStream Connect information and instructions, download the ShopStream Connect User Manual from our website: <http://diagnostics.snapon.com/usermanuals>

The ShopStream Connect™ (SSC) software is PC-based software that extends the capabilities of your diagnostic tool. Using ShopStream Connect software with your diagnostic tool allows you to do the following:

- View, Print, and Manage data saved from your Diagnostic tool.
- Move and copy your data between the diagnostic tool and your PC.
- View and Print trouble codes saved with select diagnostic tools. This allows you to share the data in a report format with vehicle owners or other technicians.
- Add or edit notes and comments to diagnostic tool data files.
- Download and install diagnostic tool software updates and upgrades.

The ShopStream Connect (SSC) software is available (free of charge) at:

ShopStream Connect - <http://diagnostics.snapon.com/ssc>

14.1 Using SSC (Connecting to your PC)



To connect and use SSC with your diagnostic tool:

1. Download and install SSC on your PC from: <http://diagnostics.snapon.com/ssc>
2. Turn your diagnostic tool on.
3. Connect the supplied USB cable from the USB jack on your diagnostic tool to your PC:
4. From the diagnostic tool Home screen, select **Tools > Connect-to-PC**.

The “**Device is now in Connect-to-PC mode**” screen message is displayed (Figure 14-1) and the ShopStream Connect software will open automatically on your PC (Figure 14-2).

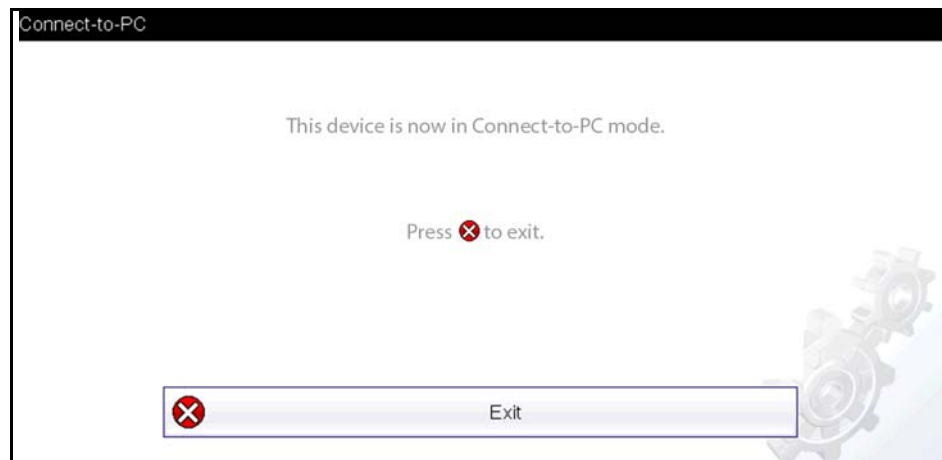

Figure 14-1

If the ShopStream Connect software does not open, open it from the Windows Start menu or use the ShopStream Connect shortcut icon on the Windows desktop (automatically created during installation).

14.2 SSC Main Screen

The ShopStream Connect software will open automatically when you connect the diagnostic tool to your PC USB connection, [Using SSC \(Connecting to your PC\)](#), on page 106,.

The following shows the main screen layout for ShopStream Connect software.

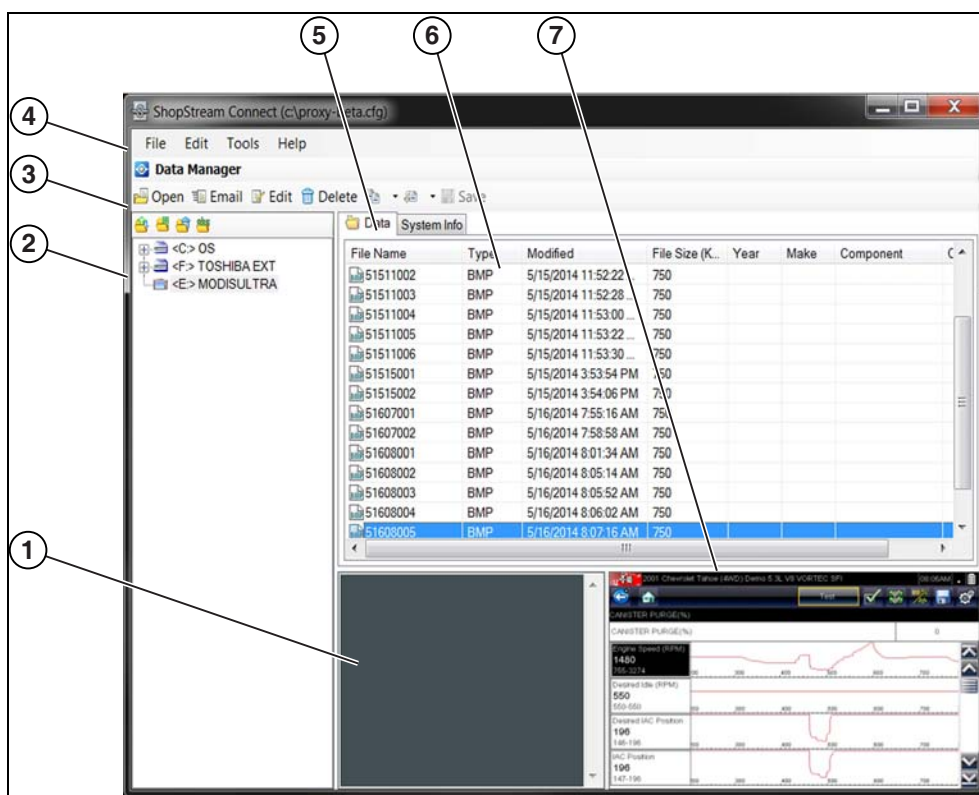

Figure 14-2

- 1— **Notes Window**—allows you add notes to select data files. Select Save from the menu bar to save your notes. *NOTE: Not all file types allow notes, the Notes window will be grayed out when a file type that does not support notes is highlighted. Some image files may display notes for reference purposes (the notes are grayed out and not editable).*
- 2— **File directory structure**—displays the file directory structure of your PC in standard Windows format, and shows any connected diagnostic tools at the bottom of the data list.
- 3— **Data Manager Toolbar**—provides control icons that perform a variety of operations on data files.
- 4— **Main Menu bar**—contains **File**, **Edit**, **Tools**, and **Help** menus.
- 5— **Tabs**—provides access to data files and presets stored on the diagnostic tool or on the PC, and also allows viewing of software revision details of the diagnostic tool.

- 6— **Main display**—shows stored data files details. *NOTE: The files listed are sortable (ascending/descending) by clicking on the column tab at the top (e.g. File Name, Type, etc.) Sort preferences are saved when the ShopStream Connect program is closed.*
- 7— **Preview**—displays a sample of the file if the selected file is a image file.

14.3 Scanner DataViewer

SSC allows you to view data files recorded with your diagnostic tool, on your PC. When a Scanner data file is selected, it opens and displays in the Scanner DataViewer (Figure 14-3). Scanner DataViewer allows you play the data file and custom configure the data in a number of ways.



- 1— Menu bar
- 2— Display toolbar
- 3— Graph display
- 4— Properties icon
- 5— Vertical Scroll bar
- 6— Zoom controls
- 7— Slider bar
- 8— Navigation toolbar
- 9— Parameter text list
- 10—Highlighted PIDs - indicates graphs currently displayed
- 11—Parameter configuration tabs

Figure 14-3

14.4 Image Viewer

SSC allows you to view and print .bmp, .jpg and .sps image files (screenshots) saved on your diagnostic tool, with your PC.

**NOTE:**

File extension types vary depending on the diagnostic tool. Not all the file extensions described here may be available on your diagnostic tool.



1— Exit - closes the Image Viewer
2— Print - prints the image

3— Print Preview - allows the image to be previewed before printing
4— Captured Screen Image

Figure 14-4

14.5 Printing the Code Scan Report

To print the Code Scan Report, the saved code scan .XML file must be opened using ShopStream Connect.

To print the Code Scan Report using ShopStream Connect:

1. Double-click the code scan .XML file from the file list to open the report (Figure 14-5) in the Code Scan Viewer (Figure 14-6).

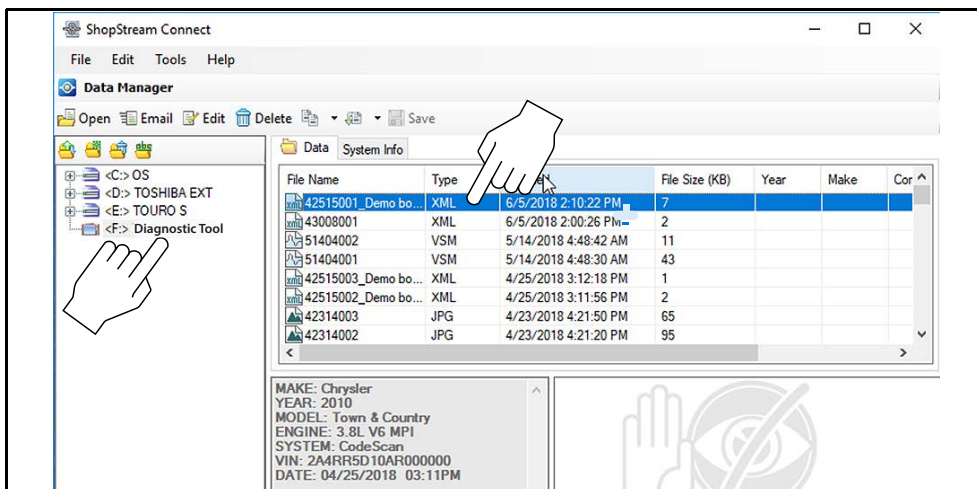

Figure 14-5

2. Select **Print** or **Print Preview** from the Code Scan Viewer menu to print or preview the report (Figure 14-6).

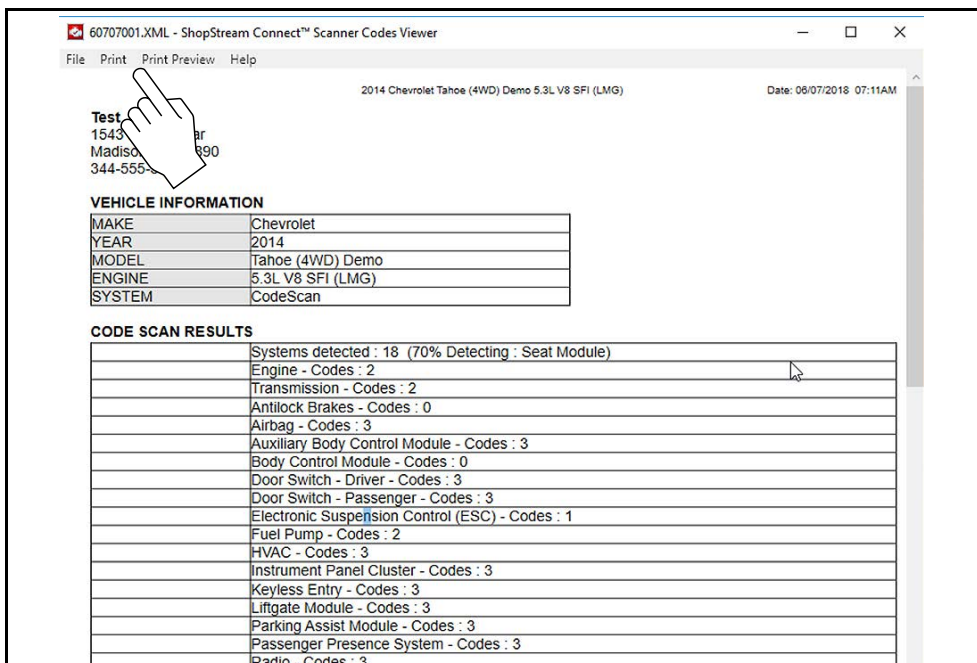

Figure 14-6

Selecting **Print** opens the Windows print dialog window (Figure 14-7). Select your printer from the list, then select **Print** to print the report.

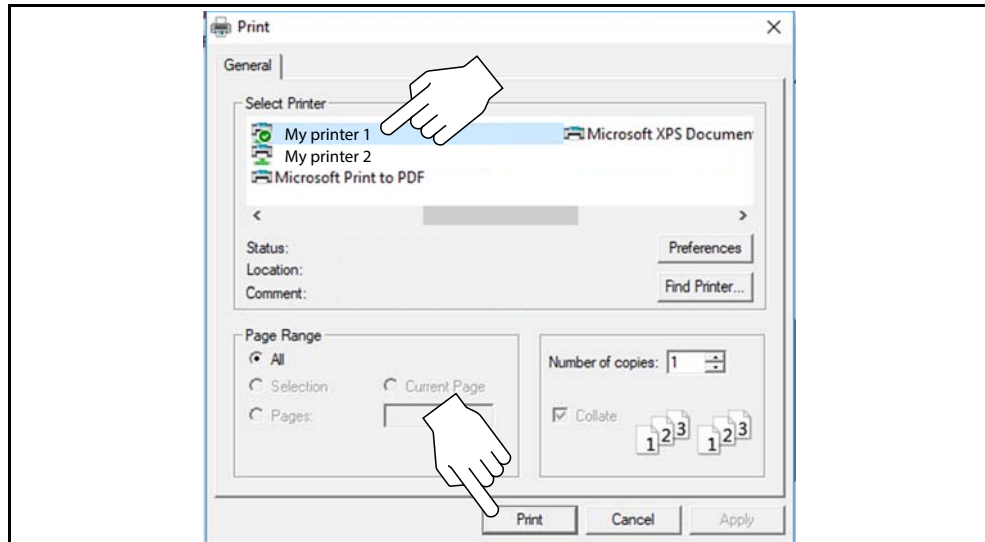

Figure 14-7

14.6 Software Upgrades and Updates

Upgrade/Update Descriptions:

- **Software Upgrade** - a software upgrade is a new software version (contact your sales representative for purchase information).
- **Software Update** - a software update is a service release for installed software. These are available free of charge, and are provided as necessary to update installed software. When your diagnostic tool is connected to a PC using SSC, the SSC software will automatically check for updates, and if an update is available, it will provide installation instructions. Follow the screen prompts to accept, download and install the software.



NOTE:

To receive updates or upgrades, SSC software must be installed on your PC and have connection to the Internet.



Example - Updating diagnostic tool software:

1. Select **Tools > Update Software > (diagnostic tool type - e.g. ETHOS Edge, MODIS Edge, SOLUS Edge, etc.)** from the Menu bar (Figure 14-8).

The software checks the Snap-on web server for available updates.

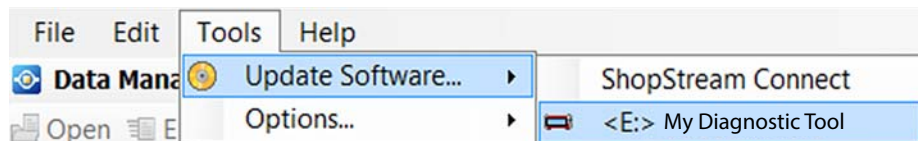

Figure 14-8

2. If service release updates are available, select **Next** to continue, then select **Download** and follow the on-screen instructions to complete the installation (Figure 14-9).

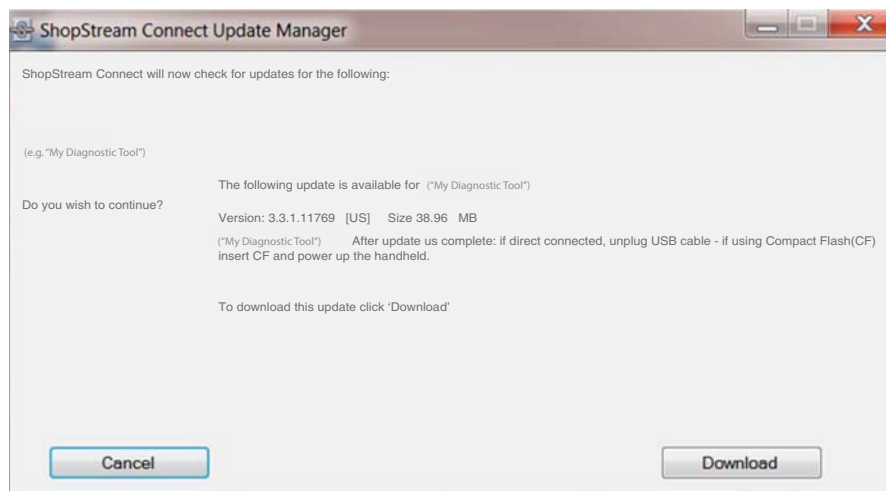

Figure 14-9



NOTE:

For additional information on ShopStream Connect software updates and upgrades, download the ShopStream Connect User Manual from our website: <http://diagnostics.snapon.com/usermanuals>

14.6.1 End User License Agreement

Before software installation at initial purchase, and before all subsequent software updates/ upgrades installations End User License Agreement (EULA) acceptance is required.

IMPORTANT:

Use of Software is governed by the terms and conditions of the End User License Agreement. The diagnostic tool should not be initially operated until the End User License Agreement is read. Use of the device acknowledges your acceptance of the End User License Agreement. The Snap-on Incorporated Software End User License Agreement is available at: <https://eula.snapon.com/diagnostics>

To Accept: at the screen prompt (Figure 14-10) click the checkbox on the left side of the window, and then select **Agree and Continue**. The software will be installed automatically.

Figure 14-10 below represents a typical EULA acceptance agreement screen.

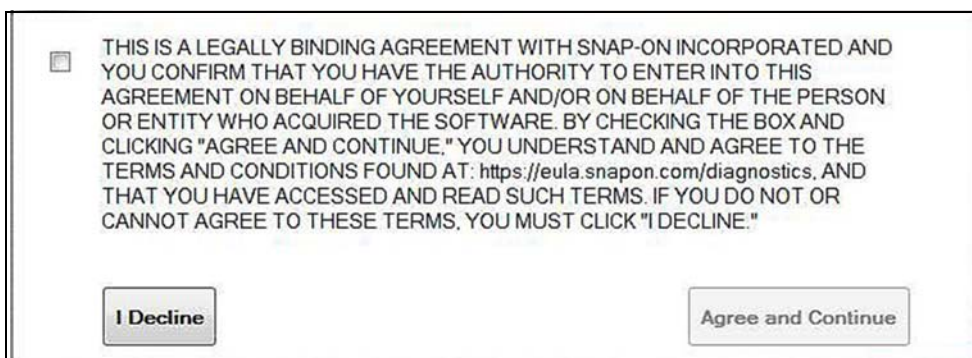

Figure 14-10 Typical EULA acceptance screen

To Decline: at the screen prompt (Figure 14-10) select **I Decline**. A confirmation message is displayed providing options to Go Back or Exit the software installation (Figure 14-11).

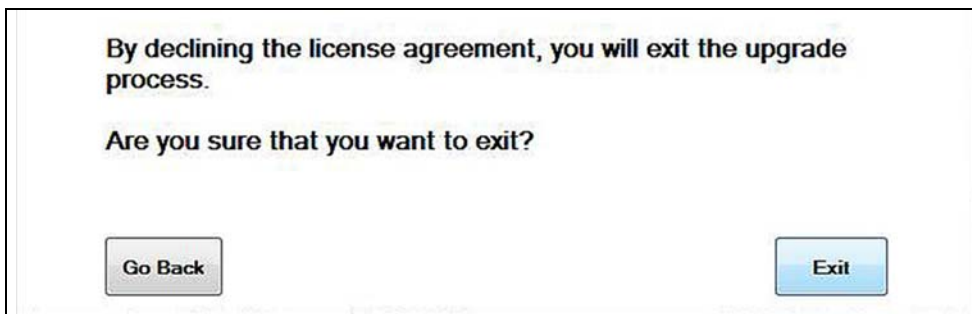

Figure 14-11 Typical EULA acceptance screen

15.1 SureTrack - Online Community

Your diagnostic tool includes access to the online SureTrack Community. You can use your PC to access the latest Real Fixes, Related Tips, and Common Repair Procedures information.

SureTrack is an evolving database of "real-world" automotive repair knowledge based on expert knowledge and millions of actual repair orders. It was designed to help you improve diagnostic accuracy and reduce repair times.

15.1.1 Main Topic Links

- [Finding your SureTrack Authorization Code](#) page 115
- [Creating a SureTrack Account](#) page 116
- [Logging In \(active account\)](#) page 120
- [Logging In with New Authorization Code \(active account\)](#) page 121
- [SureTrack Features](#) page 124
- [SureTrack Screens](#) page 125

15.1.2 Quick Reference

SureTrack Community FAQ's

For the latest SureTrack Community information and answers to frequently asked questions visit: mitchell1.com/support/suretrack-faqs/

Using SureTrack for the First Time

If you have purchased a new diagnostic tool, you will need to create a SureTrack account before you can access SureTrack. See [Creating a SureTrack Account](#), on page 116 for instructions.

Login Scenarios

- I already have an active SureTrack account with username and password - [Logging In \(active account\)](#), on page 120.
- SureTrack has already expired, but I purchased a qualifying upgrade/plan and have a new SureTrack authorization code (reactivation) - [Logging In with New Authorization Code \(expired account\)](#), on page 122.
- SureTrack is still active, but I have purchased a qualifying upgrade/plan and have a new SureTrack authorization code (reactivation) - [Logging In with New Authorization Code \(active account\)](#), on page 121.

15.1.3 Finding your SureTrack Authorization Code

When you purchase a qualifying upgrade/plan, or platform from your Snap-on Representative, you will receive a SureTrack authorization code. The authorization code is printed on your sales receipt. Authorization codes are 12 digit alpha-numeric codes (e.g. 123ABCAP4-US).

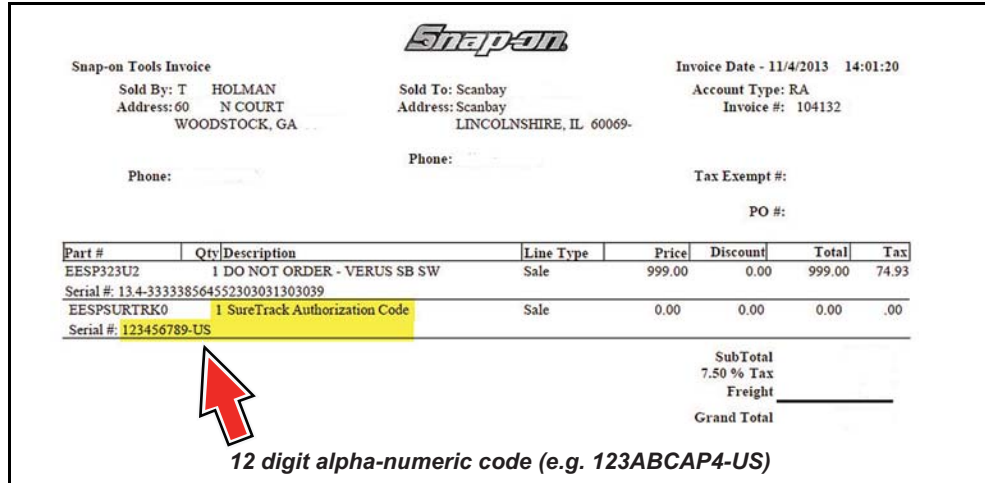

Figure 15-1

After obtaining a new upgrade/plan you will receive a new SureTrack authorization code.

Each time you purchase a qualifying diagnostics upgrade/plan you will be provided a new SureTrack authorization code. The authorization code will expire as noted in the upgrade/plan details. To log in with a new authorization code, see [Logging In with New Authorization Code \(expired account\)](#), on page 122.

15.1.4 Creating a SureTrack Account

Use Requirements

To use SureTrack you must:

- Create a SureTrack Account, see [Creating an Account](#), on page 116.
- Have a current SureTrack Authorization Code, see [Finding your SureTrack Authorization Code](#), on page 115.
- Have access to a PC with an Internet connection.

Creating an Account

If you are a new member (do not have an existing SureTrack account), you will need to complete the online registration before you can use SureTrack. Use the following procedure to create an account.

1. On your PC visit: <https://shopkeypro.com>
2. To create an account use the following illustrated instructions. Step numbers are provided in each illustration, follow the sequence to completion.

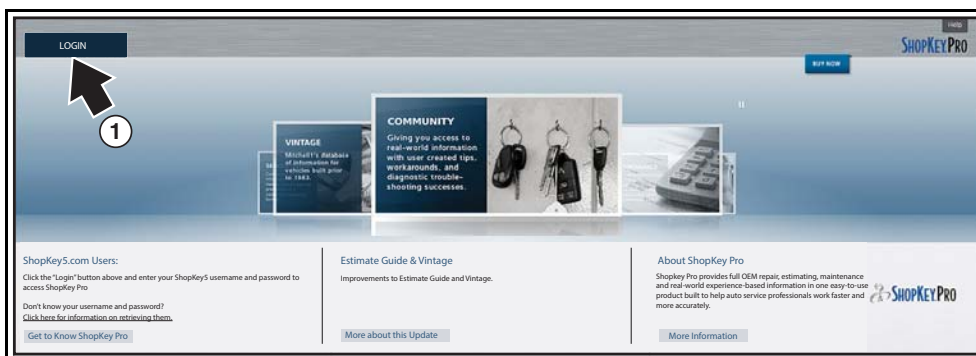

Figure 15-2

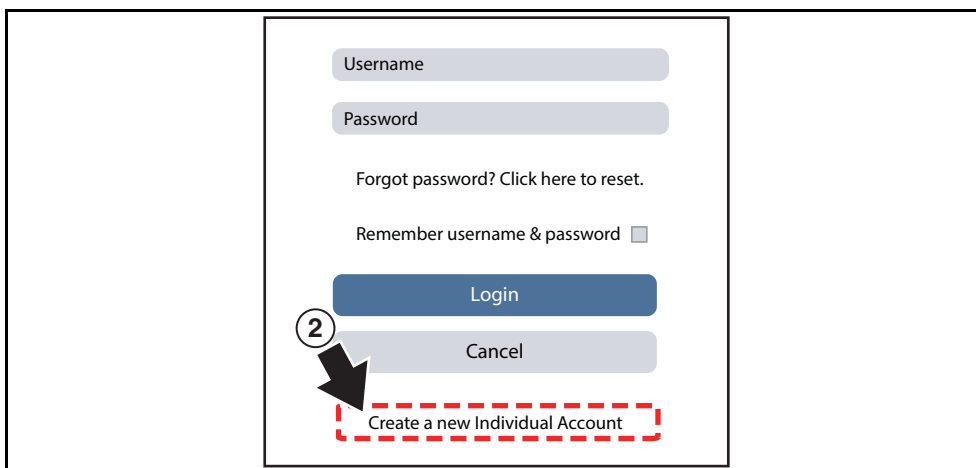

Figure 15-3

Email

3 Enter all required* information.

Email Address*

Name Phone

First Name* Last Name* Phone Number

Address

Address Line 1

Address Line 2

City* State* Zipcode

Online Profile

Username*

Password* Retype Password*

Cancel Create

4

Figure 15-4

Success X

Congratulations! Your account has been created.

This account can be used to contribute to the community and manage your profile.

To link this account to your shop, have your shop add you in Profile Manager.

Done

5

Figure 15-5

Username Password

6

Forgot password? Click here to reset. **7**

Remember username & password **7**

Login

Cancel **8**

Create a new Individual Account

Figure 15-6

9 Choose 3 security questions.

Select three questions below. These questions will help us verify your identity should you forget your password.

Question 1: Choose a question...

Question 2: Choose a question...

Question 3: Choose a question...

Cancel Submit

10

Figure 15-7

Snap-on

Snap-on Tools Invoice Invoice Date - 11/4/2013 14:01:20

Sold By: T HOLMAN Sold To: Scanbay Account Type: RA
 Address: 60 N COURT Address: Scanbay Invoice #: 104132
 WOODSTOCK, GA LINCOLNSHIRE, IL 60069

Phone: Phone: Tax Exempt #: PO #:

Part #	Qty	Description	Line Type	Price	Discount	Total	Tax
EESP323U2	1	DO NOT ORDER - VERUS SB SW	Sale	999.00	0.00	999.00	74.93
Serial #:	134-333338564552303031303039						
EESPSURTRKO	1	SureTrack Authorization Code	Sale	0.00	0.00	0.00	.00
Serial #:	123456789-US						

Sub Total
 7.50 % Tax
 Freight
 Grand Total

11 Find the SureTrack Authorization Code on your sales receipt.
 12 digit alpha-numeric code (e.g. 123ABCAP4-US)

Figure 15-8

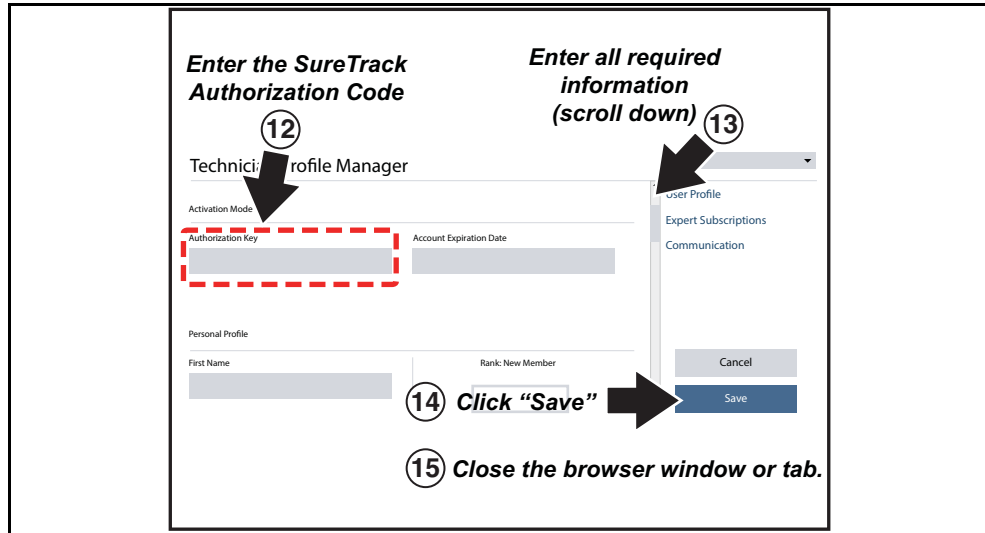

Figure 15-9

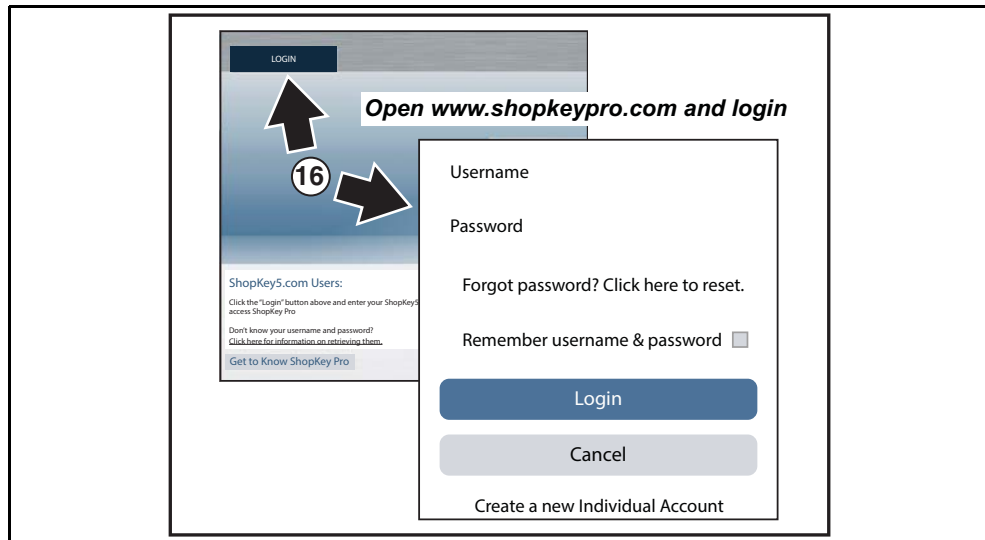

Figure 15-10

15.1.5 Logging In (active account)

If you have previously created a SureTrack account, and have a valid username and password, select **LOGIN** (Figure 15-11) from the ShopKey Pro start page, and then complete the login process (Figure 15-12). Once successfully logged in you will be directed to the 1Search *Limited* results page. See [SureTrack Screens](#), on page 125.

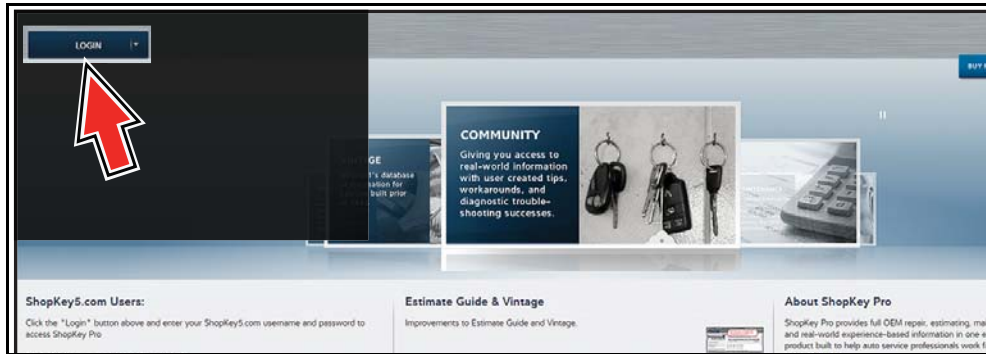

Figure 15-11

If you have previously selected the "remember me" checkbox in the login screen you will skip the login and be automatically directed to the 1Search Limited results page.

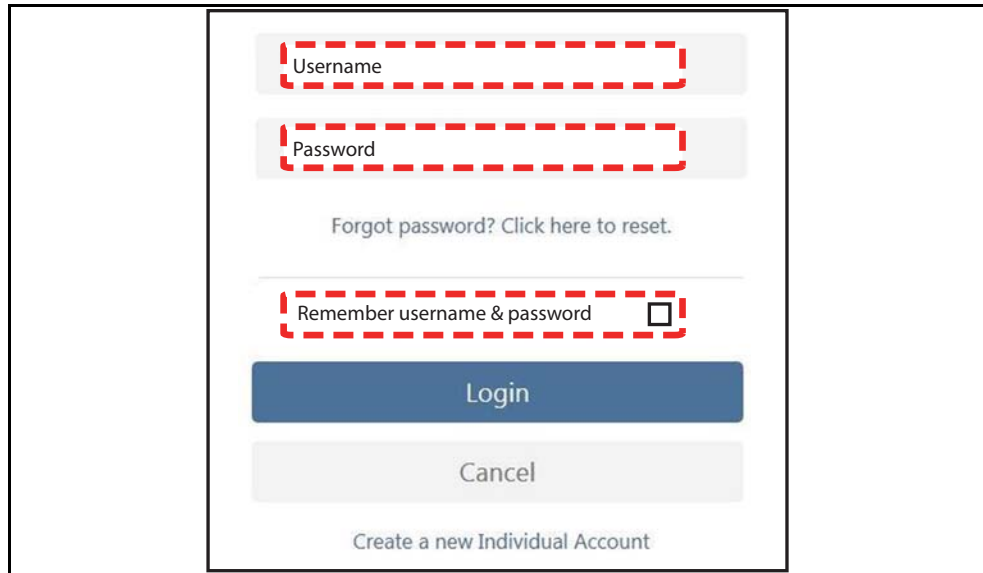

Figure 15-12

15.1.6 Logging In with New Authorization Code (active account)

Use the following instructions, if you have purchased a qualifying upgrade/plan and your SureTrack account is active (has not expired). To find your new authorization code, see [Finding your SureTrack Authorization Code](#), on page 115.

1. Log in to ShopKeyPro.com using your current username and password.
2. At the ShopKey Pro start page, select your username (Figure 15-13), then select **Profile Manager** from the dropdown menu.

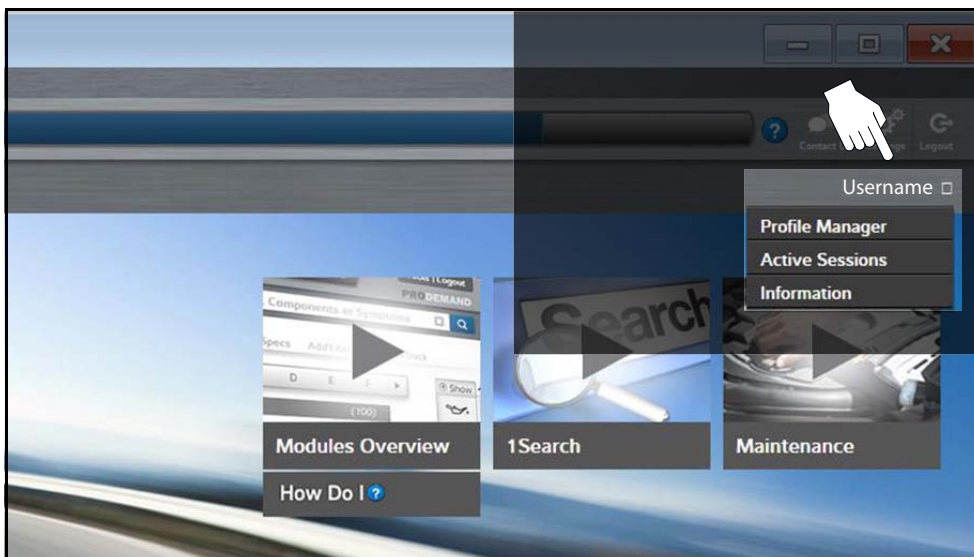

Figure 15-13

3. Log in to the Profile Manger (Figure 15-14) using your current username and password.
4. Enter your new **Authorization code** (Figure 15-14).

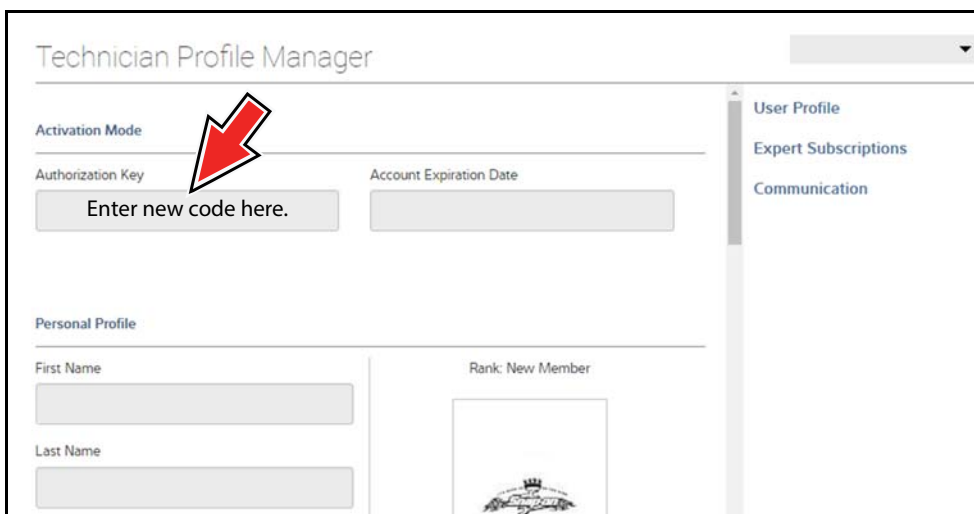

Figure 15-14

5. Review and update the rest of your profile and make sure all required fields are filled out.
6. Select **Save**.

7. Exit the Profile Manager by selecting your username (near the top right) and select **Logout**.
8. When the login screen displays, login using your current username and password.
9. Confirm the new expiration date by logging back into Profile Manger to check it.

15.1.7 Logging In with New Authorization Code (expired account)

Use the following instructions, if your SureTrack account has expired, and you have purchased a qualifying upgrade/plan. Your new upgrade/plan comes with a new SureTrack authorization code. To find your new authorization code, see [Finding your SureTrack Authorization Code](#), on page 115.

1. Log in to ShopKeyPro.com using your using your current username and password.

When your SureTrack account has expired, and you try to login you are directed to an information window ([Figure 15-15](#)).

2. Scroll down and select the link shown in ([Figure 15-15](#))

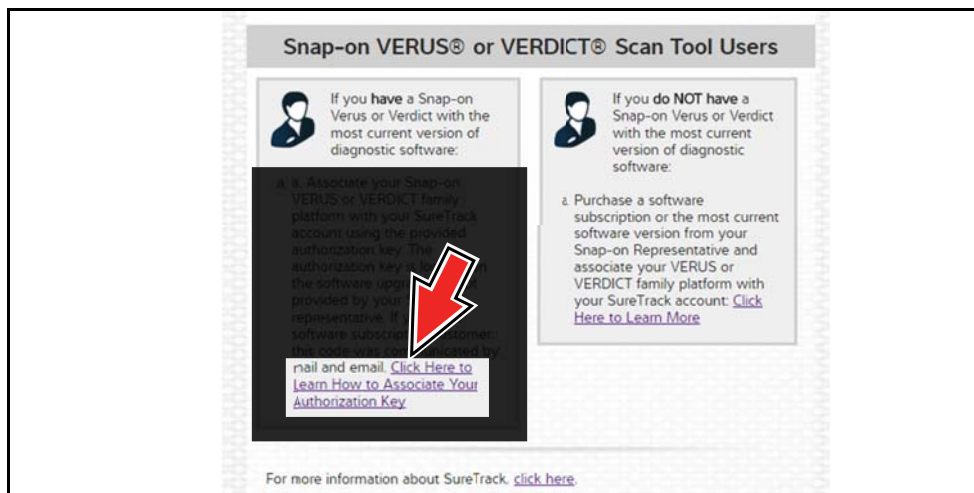

Figure 15-15

3. The SureTrack FAQ webpage opens ([Figure 15-16](#)).

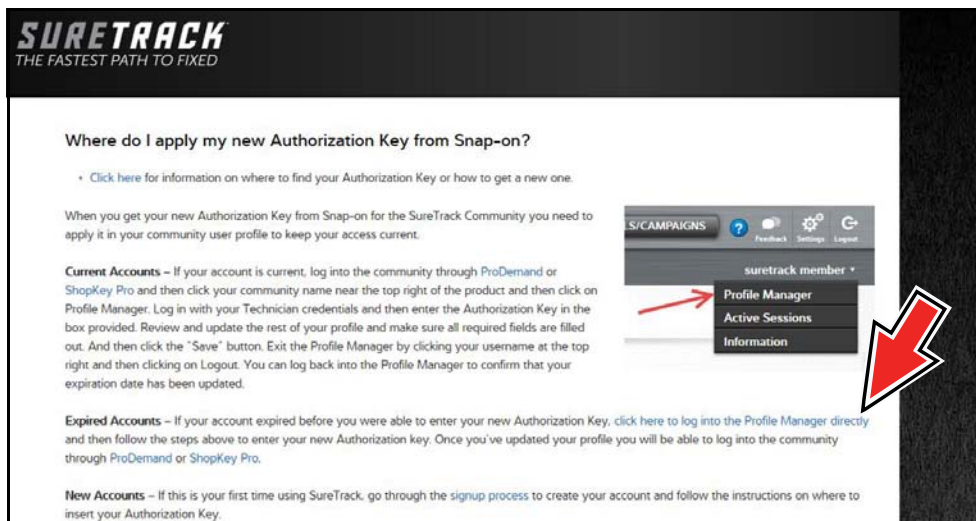

Figure 15-16

4. Scroll to the topic "Where do I apply my new Authorization Key from Snap-on?"
5. Select the link "click here to log into the profile manager login window directly".
 - URL - <https://profilemanager.mitchell1.com/technicianprofile/index>

The SureTrack renewal window opens.

6. Enter your current username and password.

The SureTrack Profile Manager window opens.

7. Enter your new **Authorization code** (Figure 15-17).

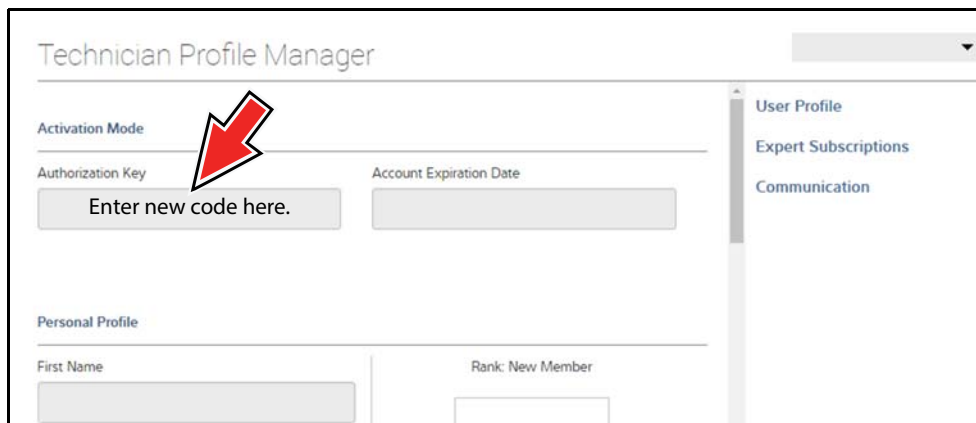

Figure 15-17

8. Review and update the rest of your profile and make sure all required fields are filled out.
9. Select **Save**.
10. Exit the Profile Manager by selecting your username (near the top right) and select **Logout**.
11. When the login screen displays, login using your current username and password.
12. Confirm the new expiration date by logging back into Profile Manger to check it.

15.1.8 SureTrack Features

SureTrack is an integrated part of ShopKey Pro, and includes two navigation modules providing search and forum capabilities:

- 1Search™ *Limited*
- Sure Track Community.

1Search™ *Limited*

The **1Search *Limited*** module includes the following information features:

- **Real Fixes and Tips** - real-world fixes and repair tips captured from actual repair orders and the experiences of professional technicians.
- **Common Repair Procedures Graph** - graphical display of the specific parts and procedures most frequently used to fix the selected code or symptom.
- **ProView** - provides graphical displays showing the direct relationship between a code or symptom to the component used to fix them.
- **Component Tests** - includes instructions on how to test the component, and descriptions of component operation, component locations, test locations, connector end views and even sample waveforms.
- **TSB's** - OEM technical service bulletins.
- **Safety Recalls and Campaigns** - safety recall and service campaign information.

SureTrack Community

The **Sure Track Community** module is a forum-based application that connects you with a community of other professional technicians to find and share information, ask questions, and provide your own tips.

15.1.9 SureTrack Screens

SureTrack Home Page (within ShopKey Pro)

The SureTrack Home page within ShopKey Pro includes:

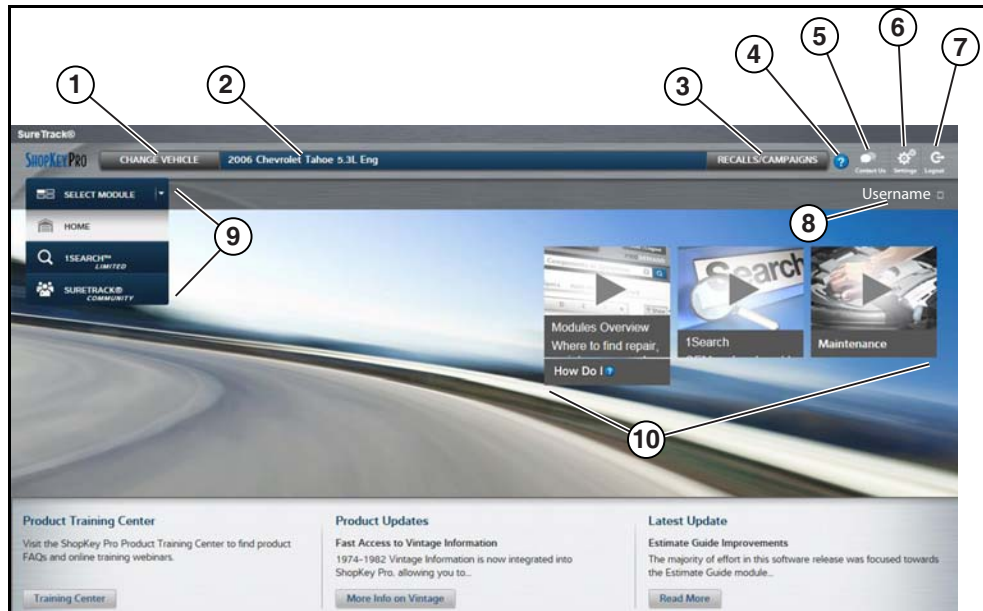

Figure 15-18

1. **Change Vehicle*** - dropdown menu provides options to change the active vehicle
2. **Active Vehicle*** - displays active vehicle
3. **Recall/Campaigns*** - displays available OEM recalls and campaigns
4. **Help*** - provides SureTrack and ShopKey Pro online help topics
5. **Contact Us*** - provides options for contacting ShopKey Pro customer service
6. **Settings*** - provides general setting options and information
7. **Logout*** - logs you off of ShopKey Pro
8. **User ID options menu*** - displays username, selecting opens Profile Manager and other options
9. **Main Menu (dropdown)*** - Options are Home, 1Search *Limited*, and SureTrack Community
10. **General Training and Information Links (various)**

* available on all pages

1Search *Limited* Top 10 Results Page

Selecting **1Search *Limited*** displays a Top 10 results page which includes:

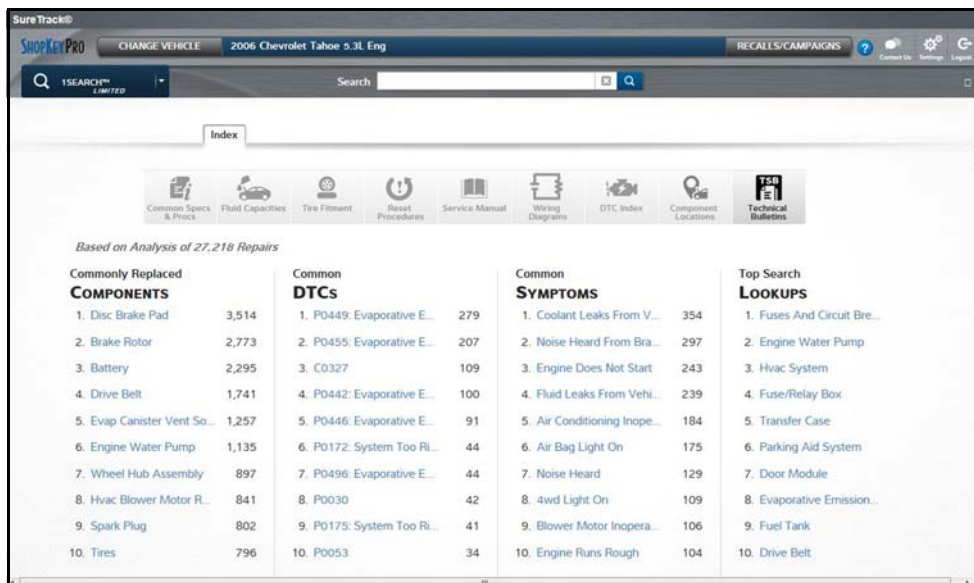

Figure 15-19

- **Search Bar** - use the search bar to enter a code, component or symptom to search. For best results keep search terms short (e.g. water pump, not - water pump replacement).
- **Page Tabs** - use the page tabs to navigate to related information (e.g. Index, SureTrack, ProView, etc) varies per application
- **Quick-links** - Technical Service Bulletins (TSBs) is the only available option
- **Repair Totals indicator** - displays the total number of repairs that all displayed data was based on
- **Top 10 lists** - display the most popular repairs and lookups by existing users for the selected vehicle (select an item from any list to view the Results Index, see [Results Index Page](#), on page 127)
 - Top 10 - Commonly Replaced Components
 - Top 10 - Common DTCs
 - Top 10 - Common Symptoms
 - Top 10 - Top Search Lookups

Results Index Page

The Results Index page includes:

- **OEM Plus Results** - provides results that best match the exact search criteria, ranked in order with the closest match at the top.
- **SureTrack Results** - provides probable components related to the search criteria, ranked in order from the most likely to the least likely component.

Select an item from either list to view the results, see [SureTrack Results Page](#), on page 128).

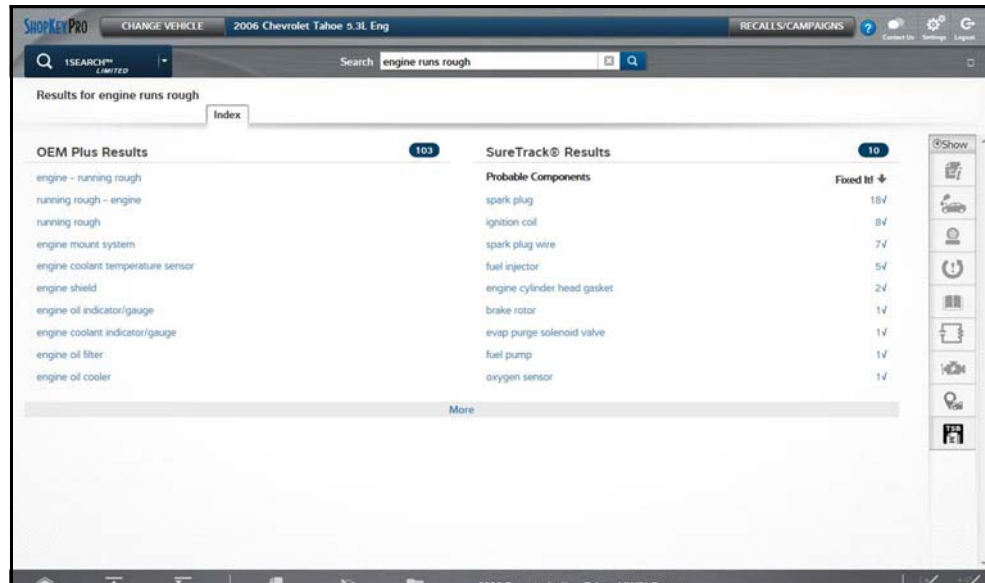

Figure 15-20

SureTrack Results Page

Selecting an item from the Results Index page displays applicable repair information on the SureTrack results page.

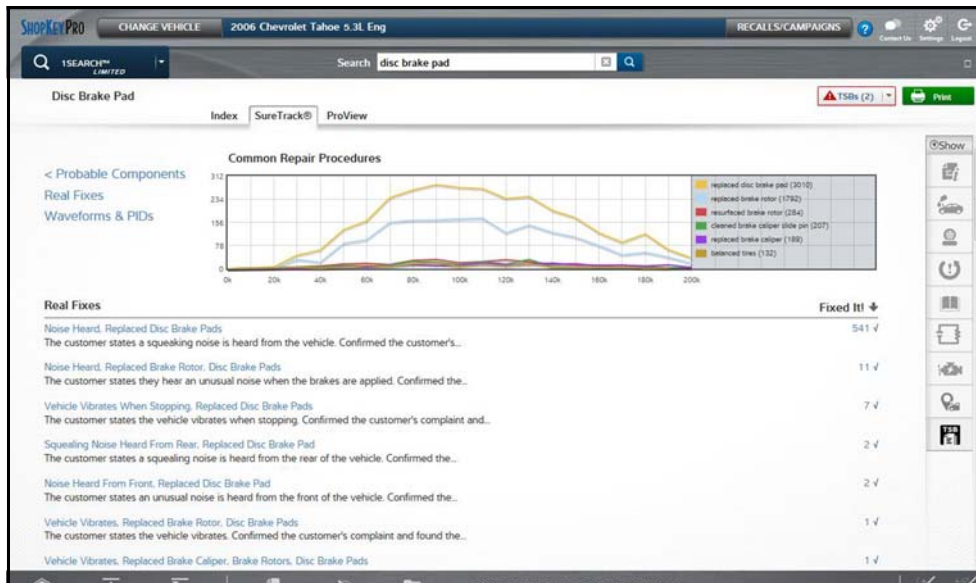

Figure 15-21

Information may include:

- **Real Fixes and Tips** - real-world fixes and repair tips captured from actual repair orders and the experiences of professional technicians.
- **Common Repair Procedures Graph** - graphical display of the specific parts and procedures most frequently used to fix the selected code or symptom.
- **Component Tests** - includes instructions on how to test the component, and descriptions of component operation, component locations, test locations, connector end views and even sample waveforms.
- **TSB's** - OEM technical service bulletins.
- **Safety Recalls and Campaigns** - safety recall and service campaign information.

ProView Results Page

Selecting the **ProView** tab from the SureTrack results page opens ProView. ProView provides graphical displays showing the direct relationship between a code or symptom to the component used to fix them.

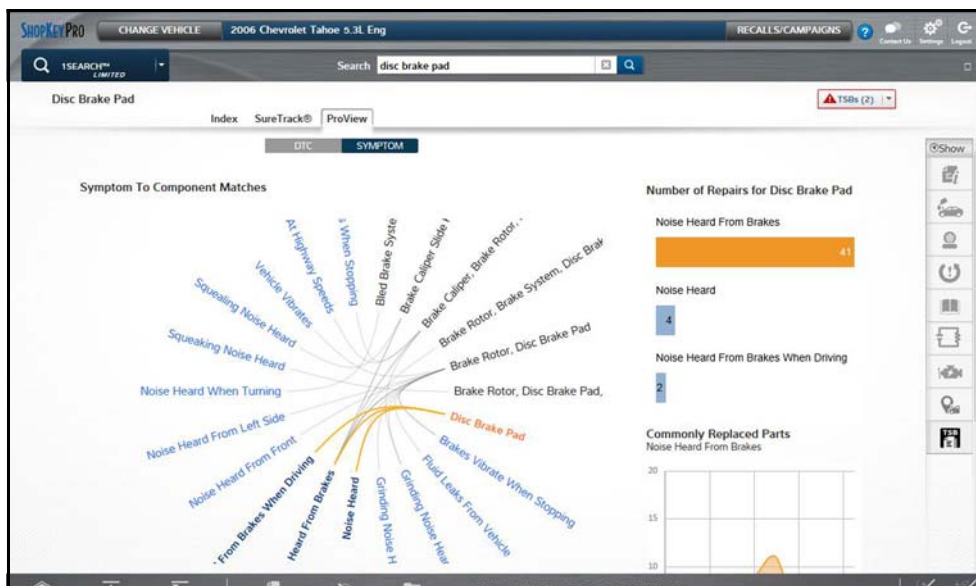

Figure 15-22

Information may include:

- **Radial Graph** - showing the relationship of the code or symptom to possible at fault components.
- **Component Frequency Graphs** - showing the most commonly replaced component for that code or symptom.
- **Common Replaced Parts Graphs** - showing the mileage at which the most common component is replaced.